

Unit 7/366 Rockonia Road

Ground Floor

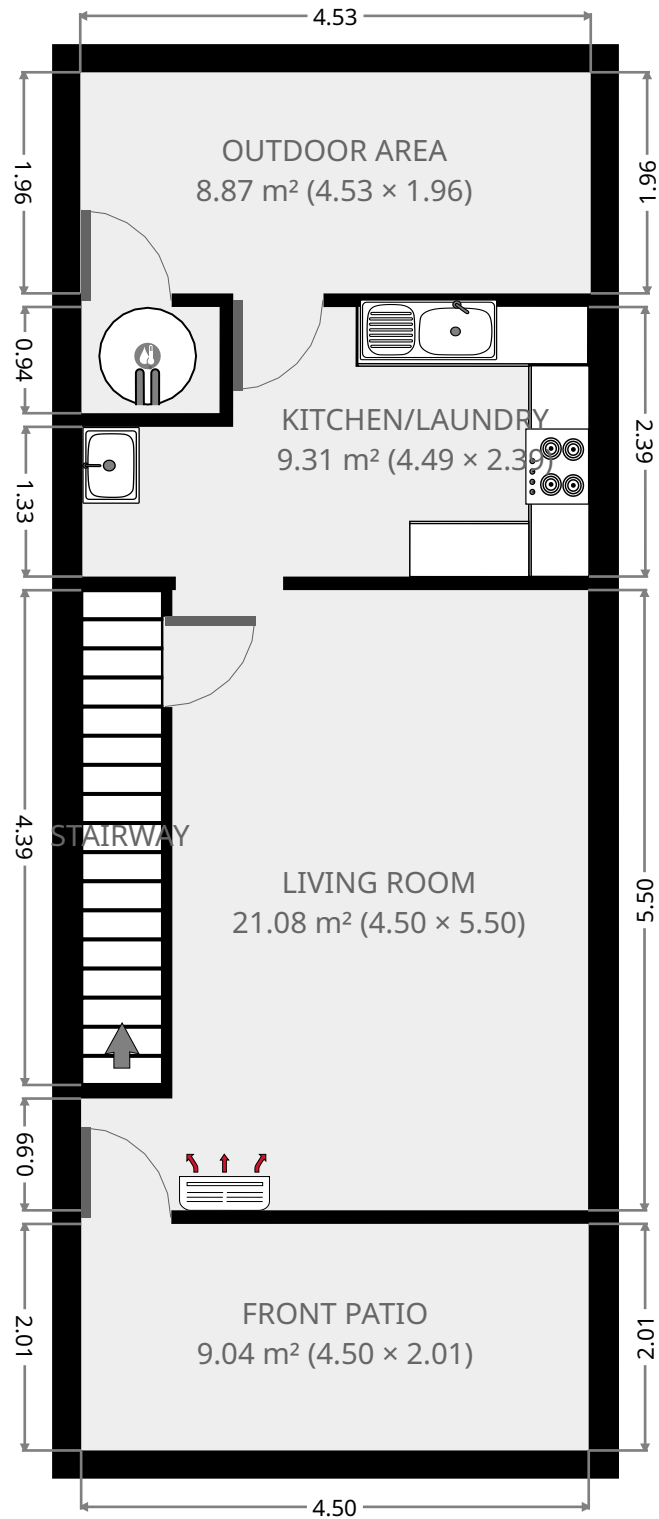

THIS FLOORPLAN IS PROVIDED WITHOUT WARRANTY OF ANY KIND. SENSOPIA DISCLAIMS ANY WARRANTY INCLUDING, WITHOUT LIMITATION, SATISFACTORY QUALITY OR ACCURACY OF DIMENSIONS.

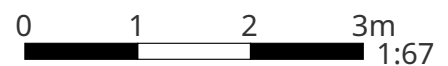

Unit 7/366 Rockonia Road

Living Room

Width: 4.50 m
Length: 5.50 m
Area: 21.08 m²
Perimeter: 19.99 m

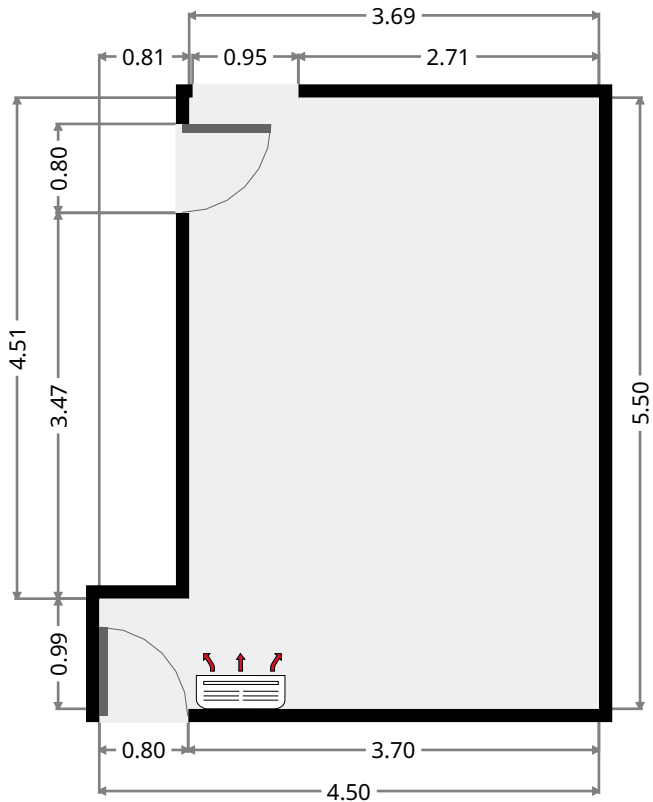
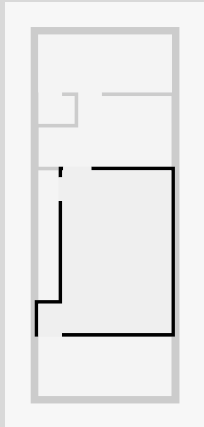

Kitchen/Laundry

Width: 2.39 m
Length: 4.49 m
Area: 9.31 m²
Perimeter: 13.76 m

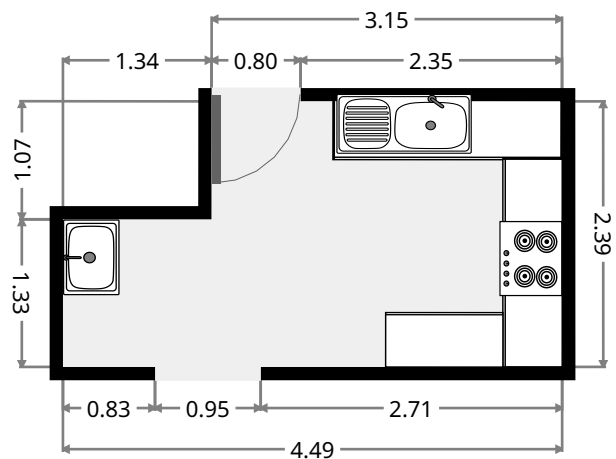
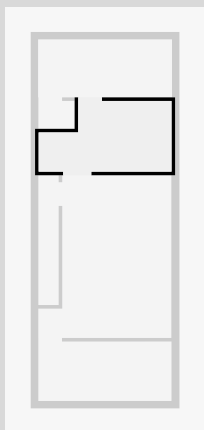

Unit 7/366 Rockonia Road

Stairway

Width: 0.69 m
 Length: 4.39 m
 Area: 3.01 m²
 Perimeter: 10.14 m

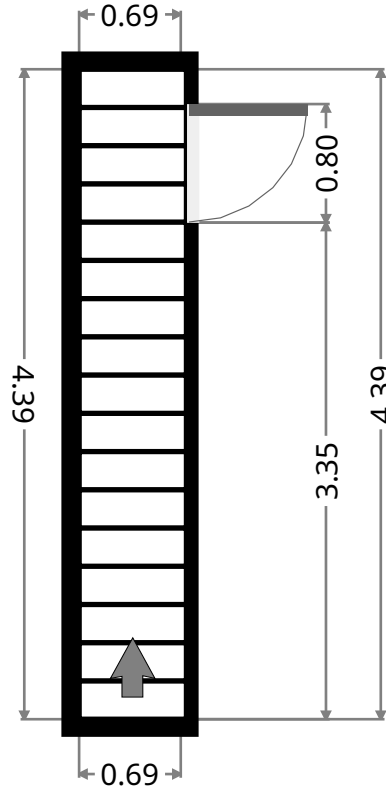
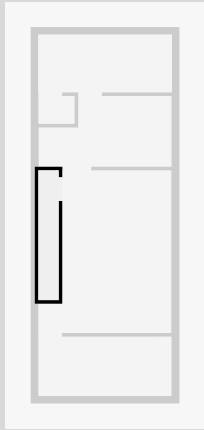

•
 Width: 0.94 m
 Length: 1.22 m
 Area: 1.15 m²
 Perimeter: 4.33 m

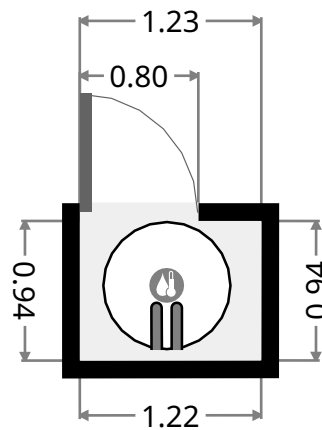
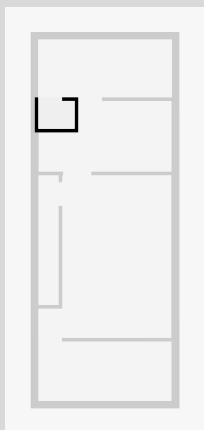

Unit 7/366 Rockonia Road

Outdoor Area

Width: 1.96 m
Length: 4.53 m
Area: 8.87 m²
Perimeter: 12.97 m

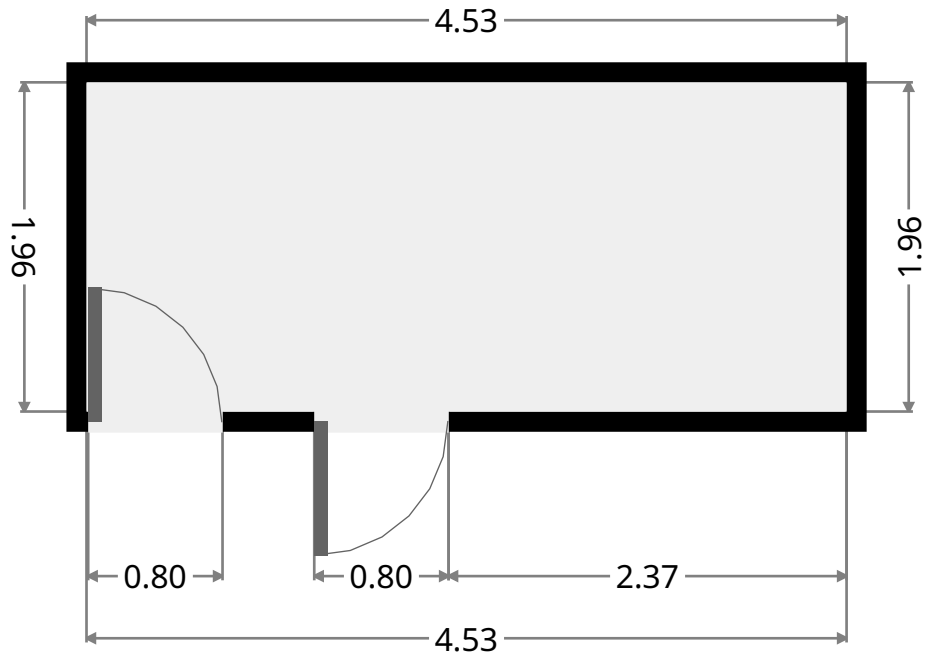
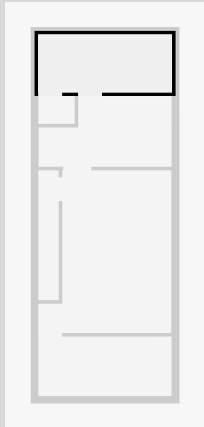

Front Patio

Width: 2.01 m
Length: 4.50 m
Area: 9.04 m²
Perimeter: 13.02 m

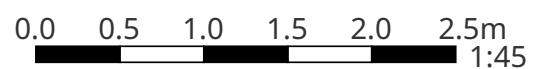
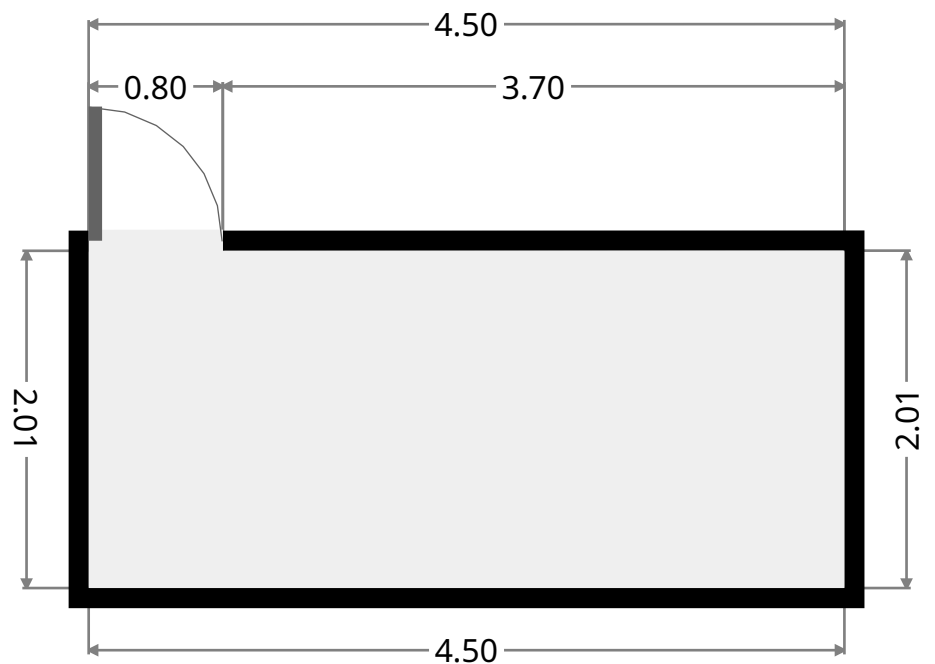
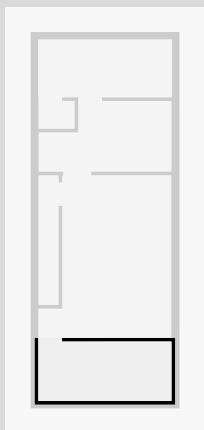

Unit 7/366 Rockonia Road

1st Floor

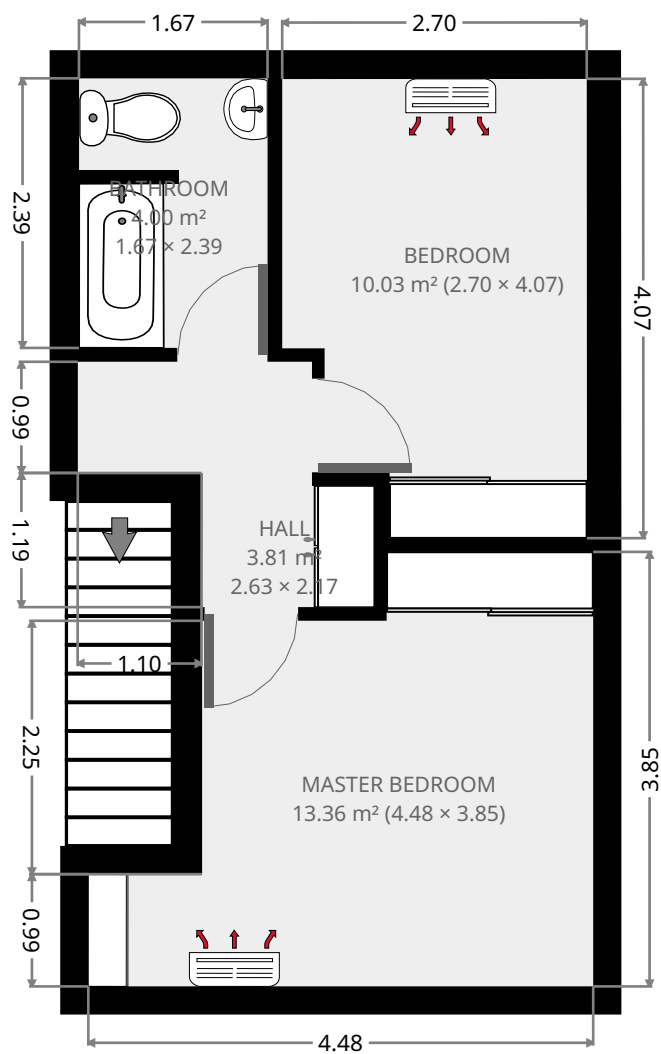

THIS FLOORPLAN IS PROVIDED WITHOUT WARRANTY OF ANY KIND. SENSOPIA DISCLAIMS ANY WARRANTY INCLUDING, WITHOUT LIMITATION, SATISFACTORY QUALITY OR ACCURACY OF DIMENSIONS.

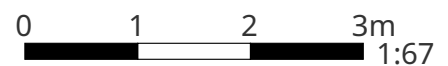

Unit 7/366 Rockonia Road

Bathroom

Width: 1.67 m
 Length: 2.39 m
 Area: 4.00 m²
 Perimeter: 8.12 m

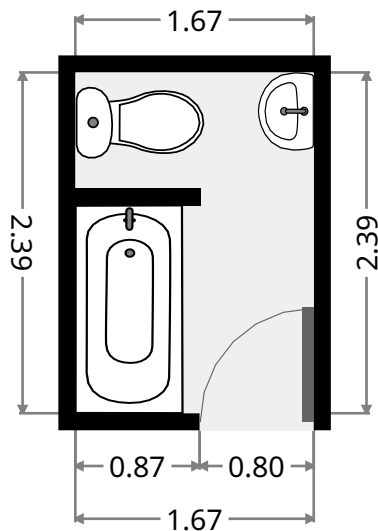
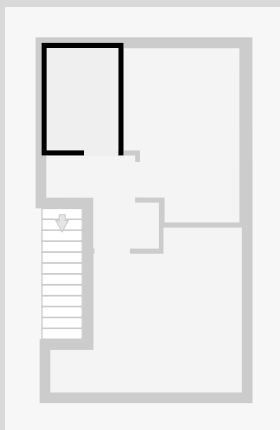

Hall

Width: 2.17 m
 Length: 2.63 m
 Area: 3.81 m²
 Perimeter: 9.62 m

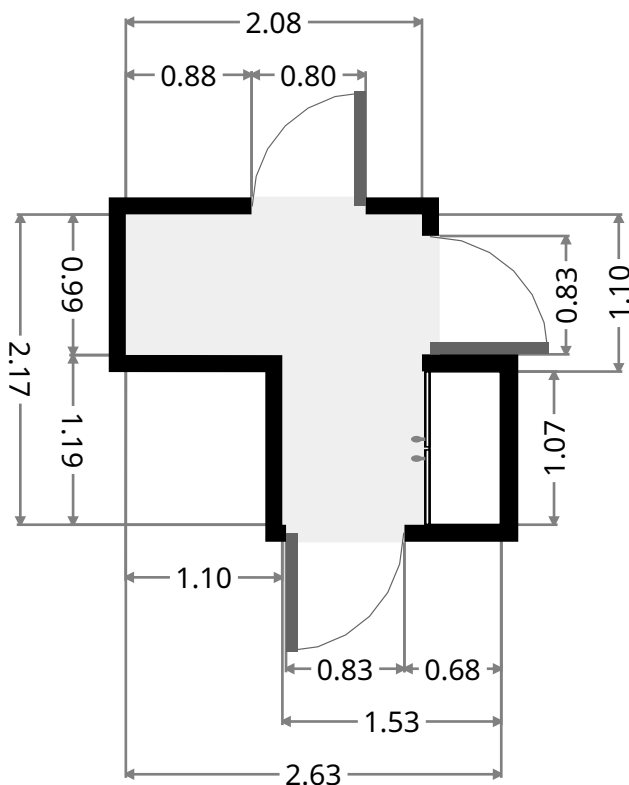
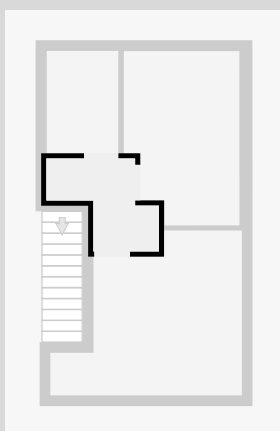

THIS FLOORPLAN IS PROVIDED WITHOUT WARRANTY OF ANY KIND. SENSOPIA DISCLAIMS ANY WARRANTY INCLUDING, WITHOUT LIMITATION, SATISFACTORY QUALITY OR ACCURACY OF DIMENSIONS.

Unit 7/366 Rockonia Road

Bedroom

Width: 2.70 m
 Length: 4.07 m
 Area: 10.03 m²
 Perimeter: 13.55 m

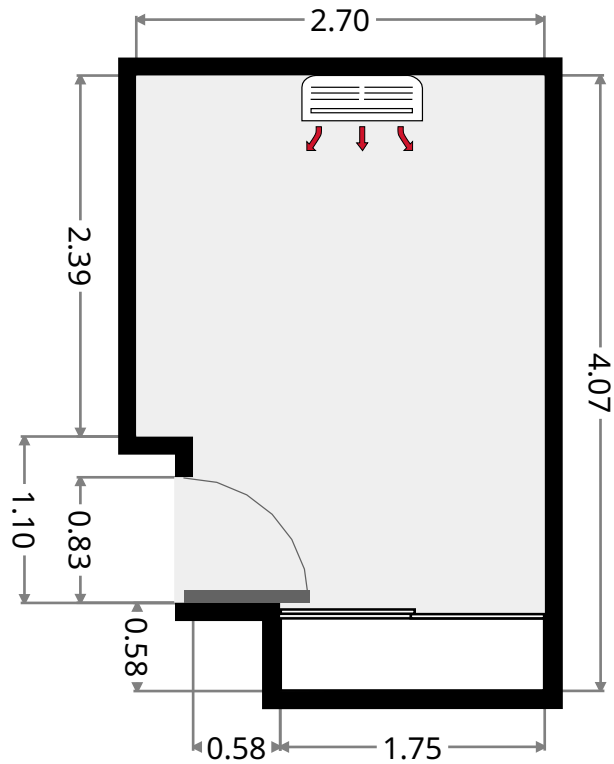
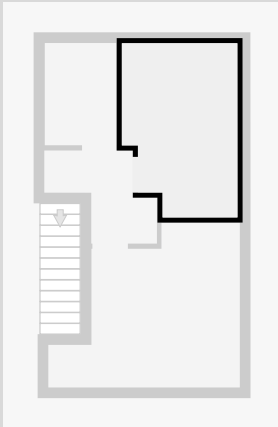

Master Bedroom

Width: 3.85 m
 Length: 4.48 m
 Area: 13.36 m²
 Perimeter: 16.66 m

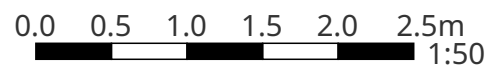
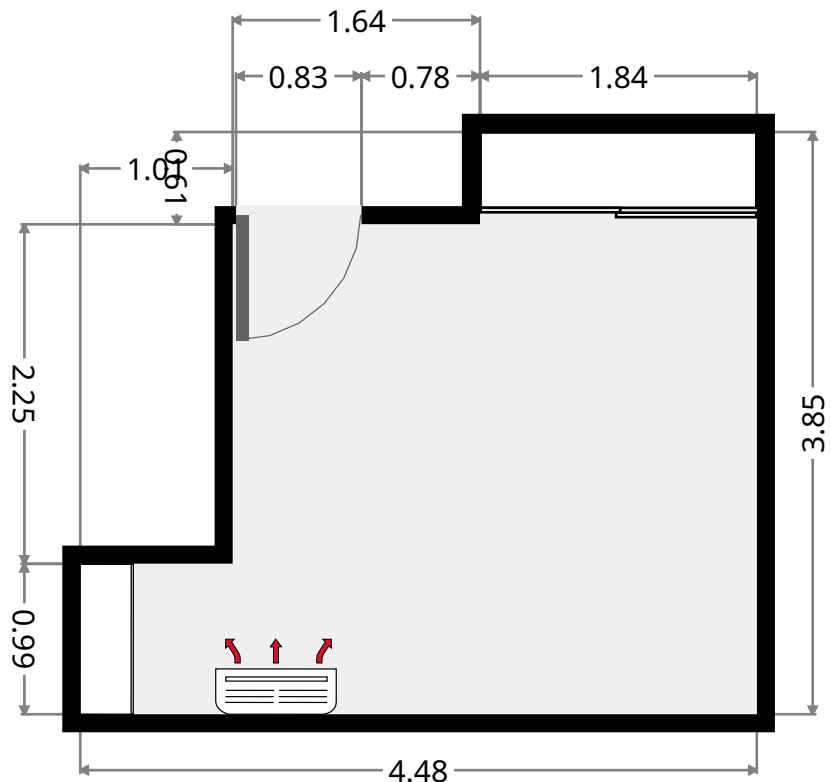
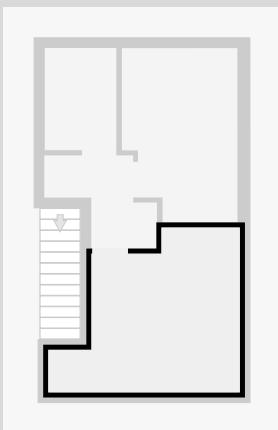

THIS FLOORPLAN IS PROVIDED WITHOUT WARRANTY OF ANY KIND. SENSOPIA DISCLAIMS ANY WARRANTY INCLUDING, WITHOUT LIMITATION, SATISFACTORY QUALITY OR ACCURACY OF DIMENSIONS.