

Unit 5/200 Denham Street

Ground Floor

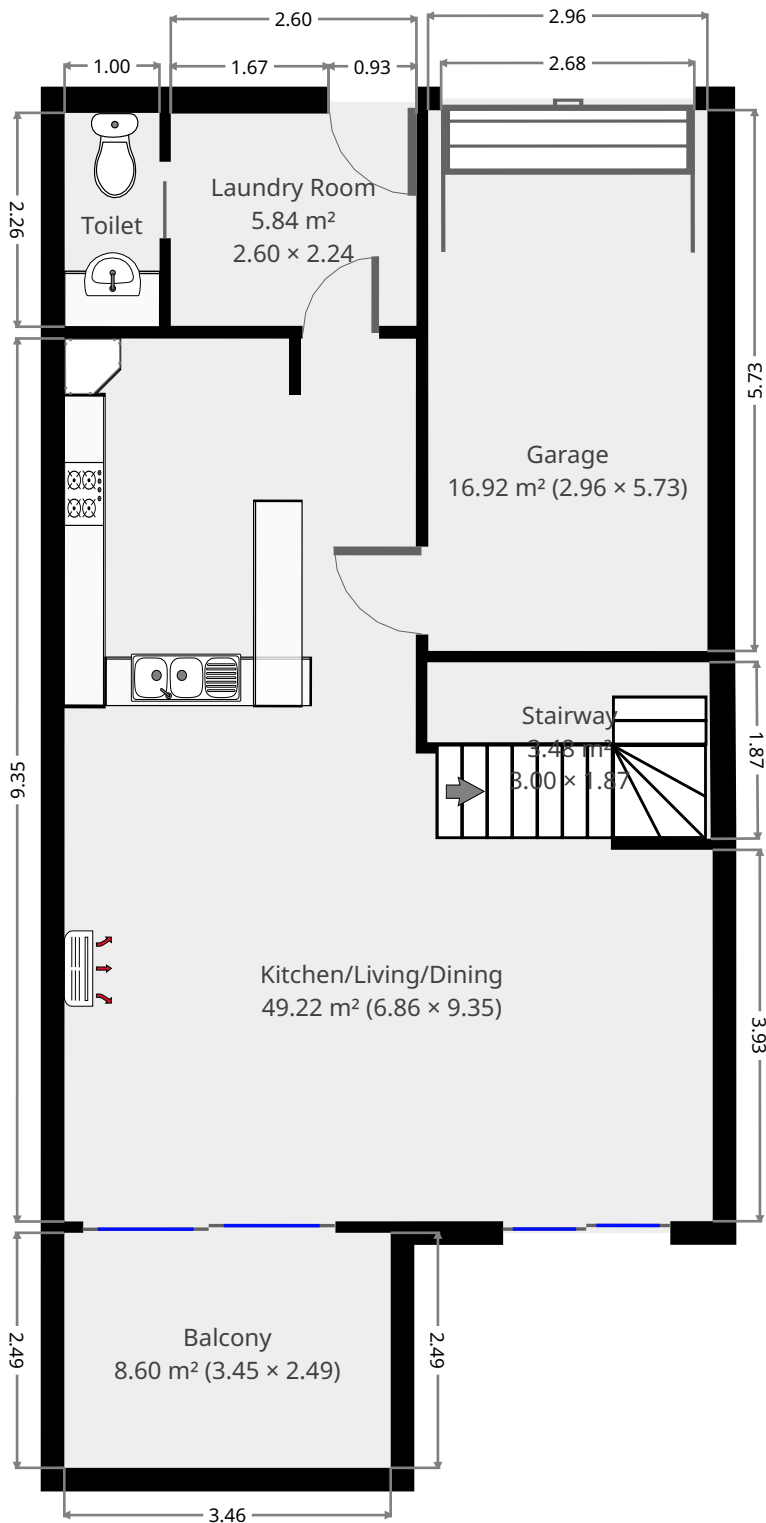

THIS FLOORPLAN IS PROVIDED WITHOUT WARRANTY OF ANY KIND. SENSOPIA DISCLAIMS ANY WARRANTY INCLUDING, WITHOUT LIMITATION, SATISFACTORY QUALITY OR ACCURACY OF DIMENSIONS.

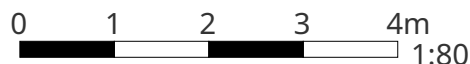

Unit 5/200 Denham Street

Kitchen/Living/Dining

Width: 6.86 m
 Length: 9.35 m
 Area: 49.22 m²
 Perimeter: 32.41 m

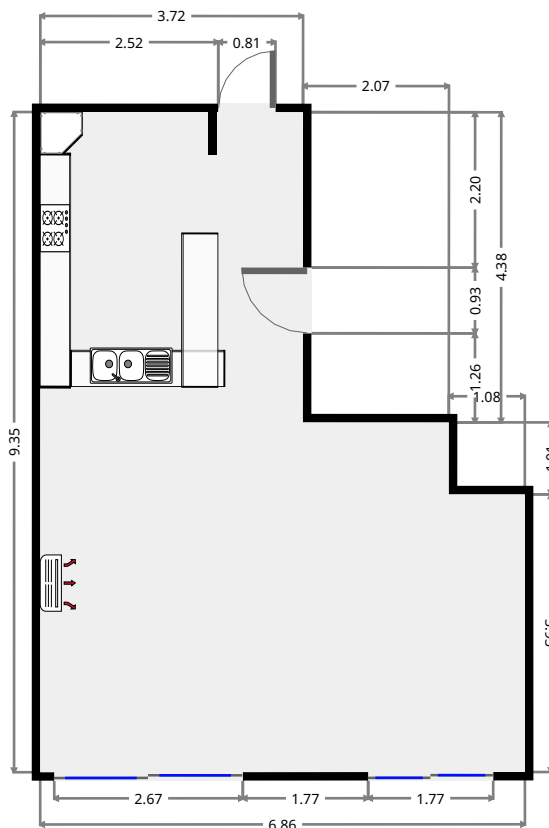
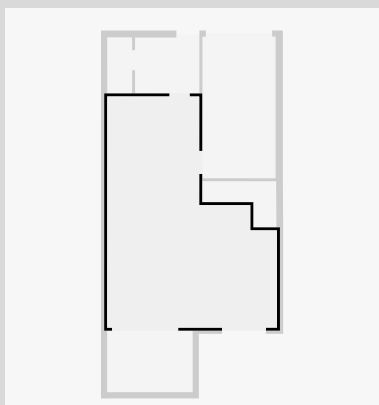

Garage

Width: 2.96 m
 Length: 5.73 m
 Area: 16.92 m²
 Perimeter: 17.36 m

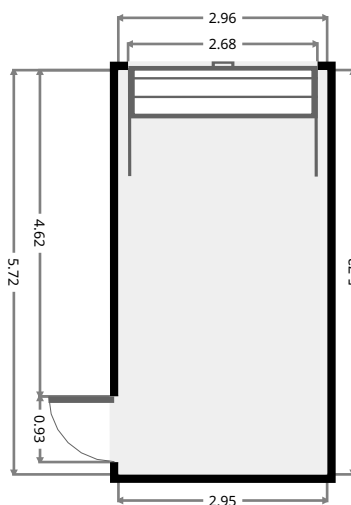
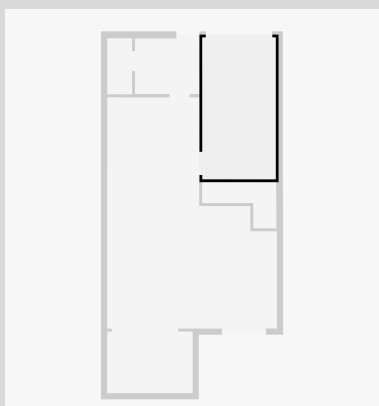

THIS FLOORPLAN IS PROVIDED WITHOUT WARRANTY OF ANY KIND. SENSOPIA DISCLAIMS ANY WARRANTY INCLUDING, WITHOUT LIMITATION, SATISFACTORY QUALITY OR ACCURACY OF DIMENSIONS.

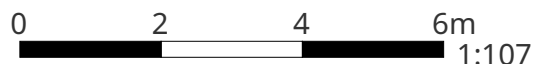

Unit 5/200 Denham Street

Stairway

Width:	1.87 m
Length:	3.00 m
Area	3.48 m ²
Perimeter	9.72 m

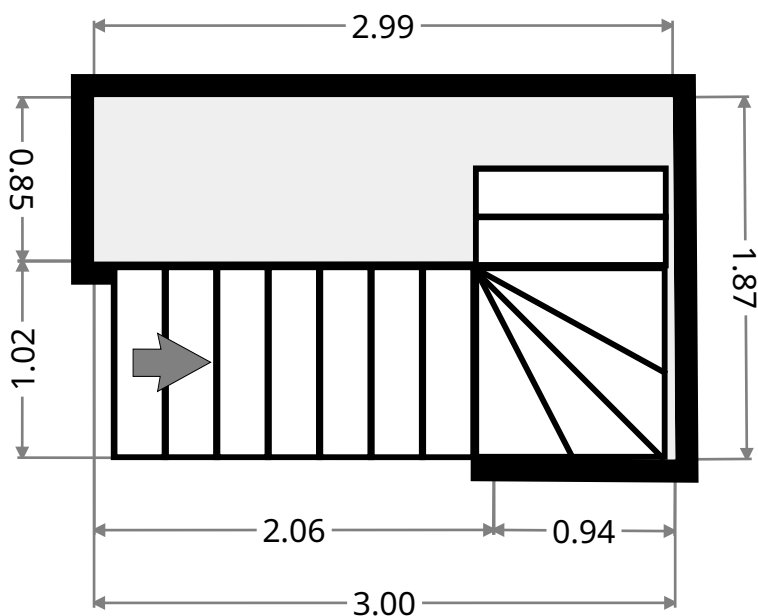
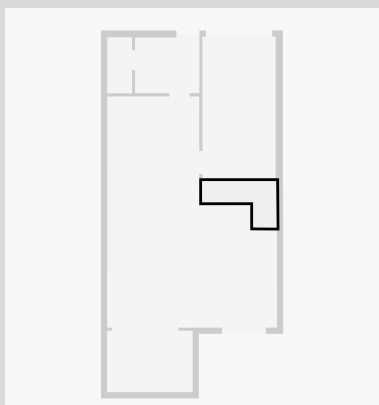

Laundry Room

Width:	2.24 m
Length:	2.60 m
Area	5.84 m ²
Perimeter	9.69 m

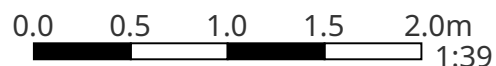
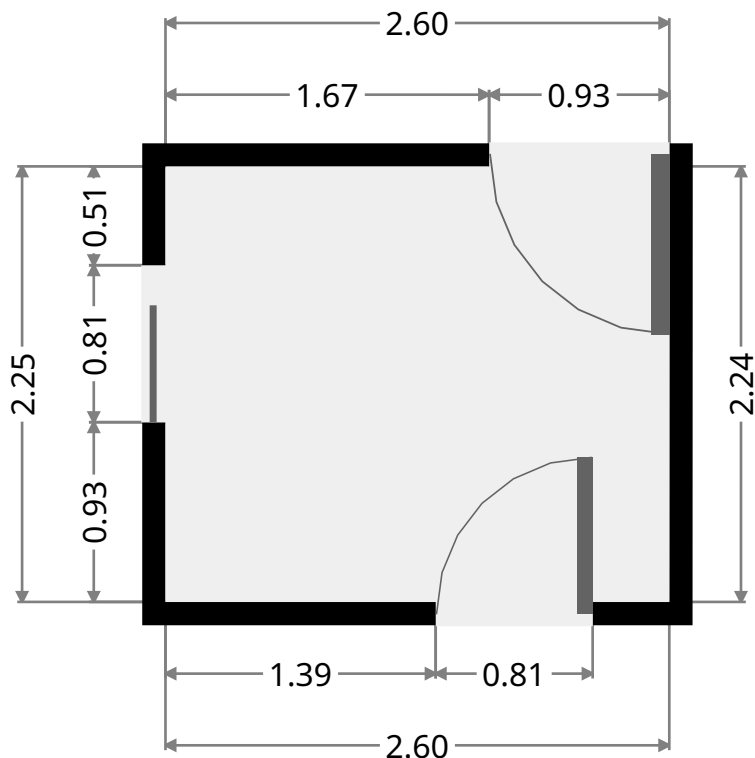
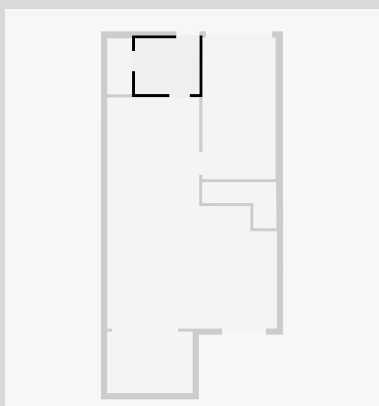

THIS FLOORPLAN IS PROVIDED WITHOUT WARRANTY OF ANY KIND. SENSOPIA DISCLAIMS ANY WARRANTY INCLUDING, WITHOUT LIMITATION, SATISFACTORY QUALITY OR ACCURACY OF DIMENSIONS.

Unit 5/200 Denham Street

Toilet

Width: 1.00 m
Length: 2.26 m
Area: 2.27 m²
Perimeter: 6.54 m

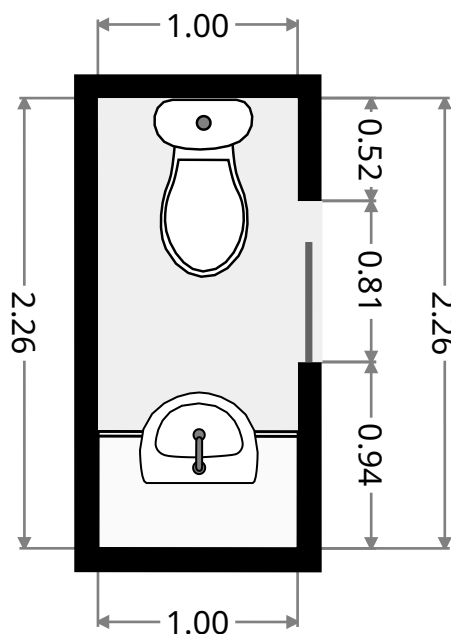
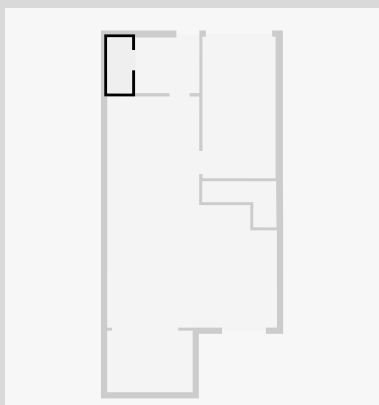

Balcony

Width: 2.49 m
Length: 3.45 m
Area: 8.60 m²
Perimeter: 11.89 m

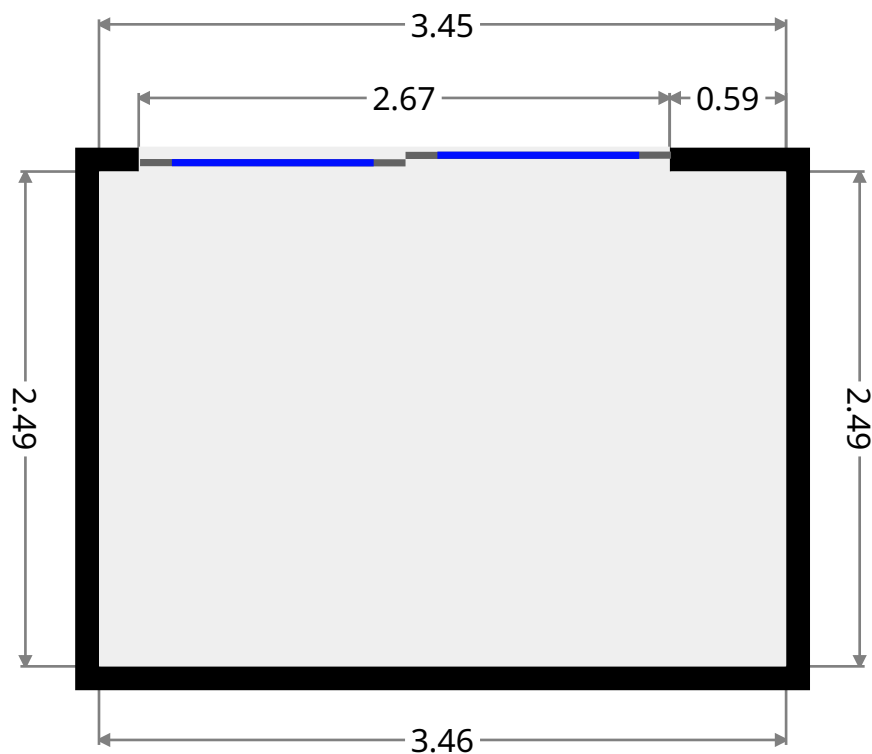
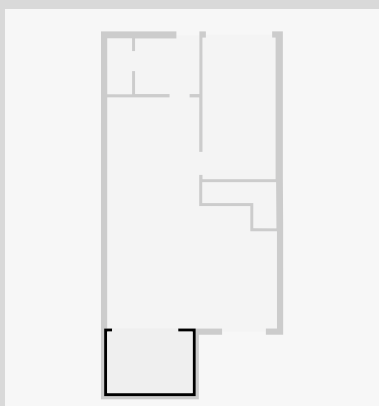

THIS FLOORPLAN IS PROVIDED WITHOUT WARRANTY OF ANY KIND. SENSOPIA DISCLAIMS ANY WARRANTY INCLUDING, WITHOUT LIMITATION, SATISFACTORY QUALITY OR ACCURACY OF DIMENSIONS.

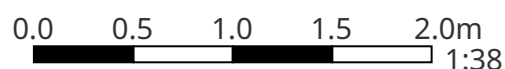

Unit 5/200 Denham Street

1st Floor

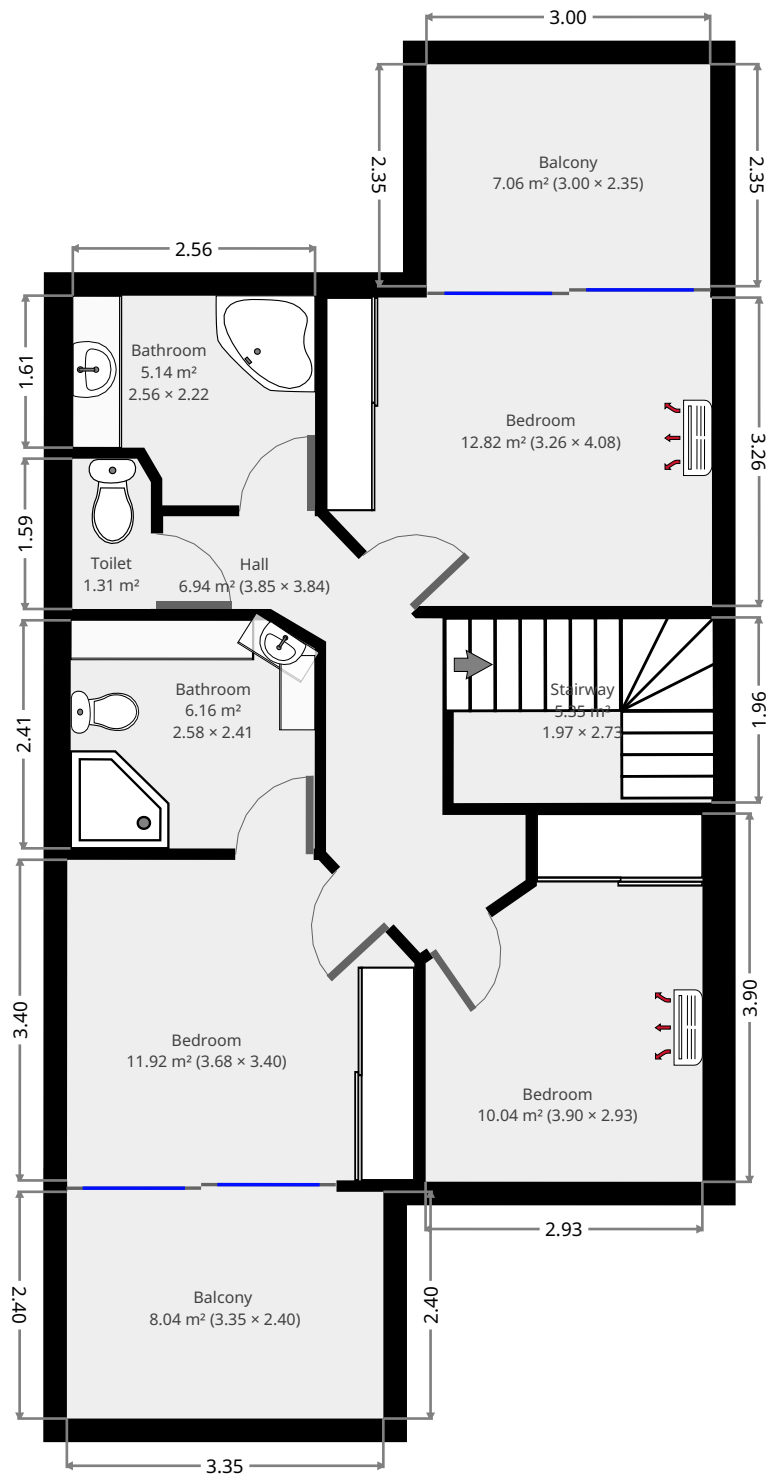

THIS FLOORPLAN IS PROVIDED WITHOUT WARRANTY OF ANY KIND. SENSOPIA DISCLAIMS ANY WARRANTY INCLUDING, WITHOUT LIMITATION, SATISFACTORY QUALITY OR ACCURACY OF DIMENSIONS.



Unit 5/200 Denham Street

Bedroom

Width: 3.40 m
Length: 3.68 m
Area: 11.92 m²
Perimeter: 13.52 m

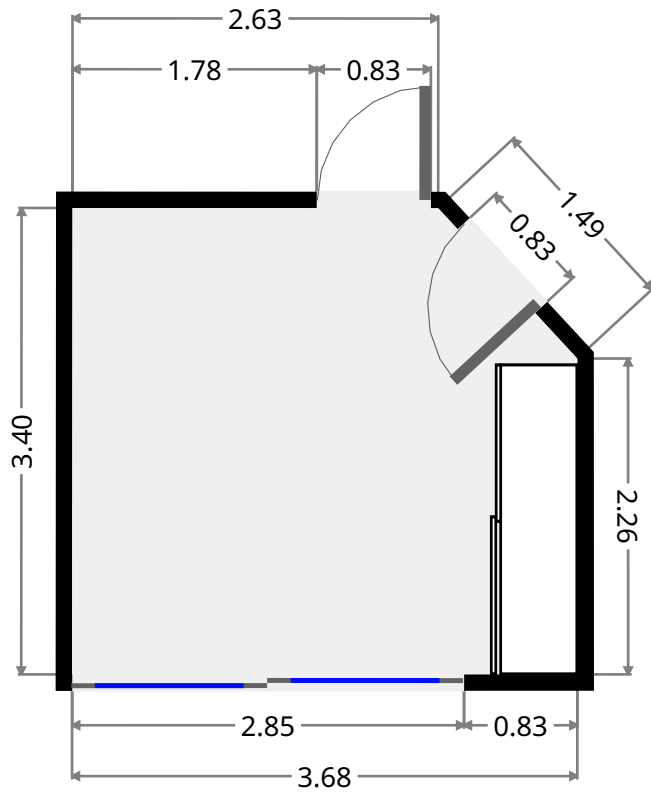
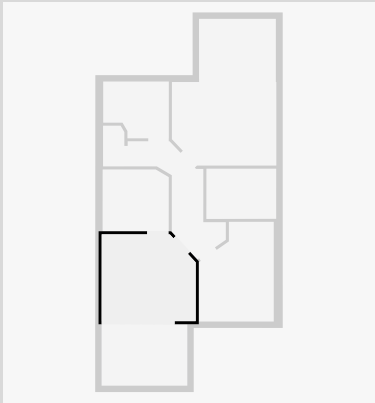

Balcony

Width: 2.40 m
Length: 3.35 m
Area: 8.04 m²
Perimeter: 11.50 m

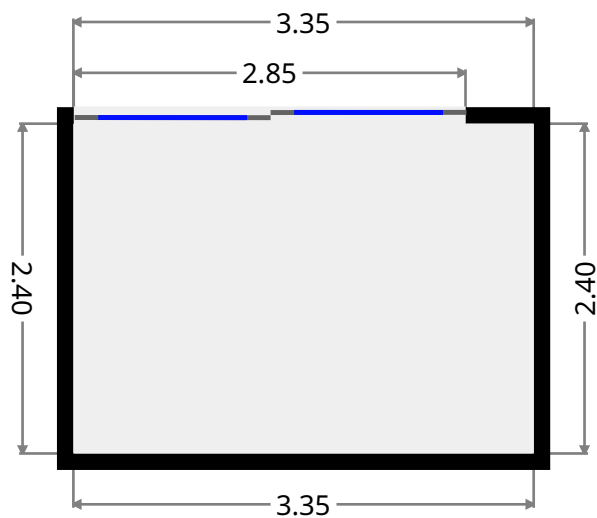
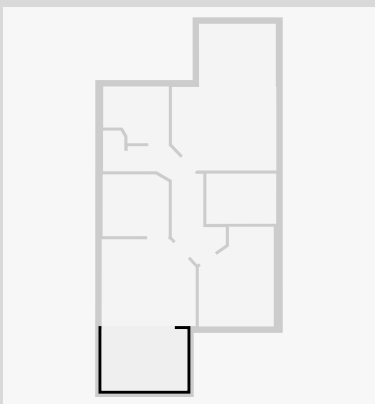

Unit 5/200 Denham Street

Bathroom

Width: 2.41 m
Length: 2.58 m
Area: 6.16 m²
Perimeter: 9.78 m

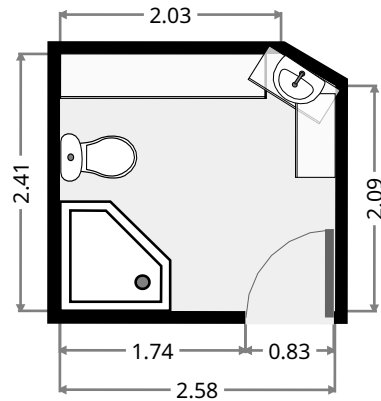
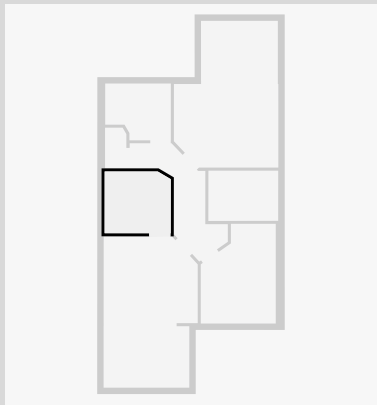

Hall

Width: 3.84 m
Length: 3.85 m
Area: 6.94 m²
Perimeter: 14.91 m

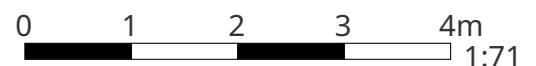
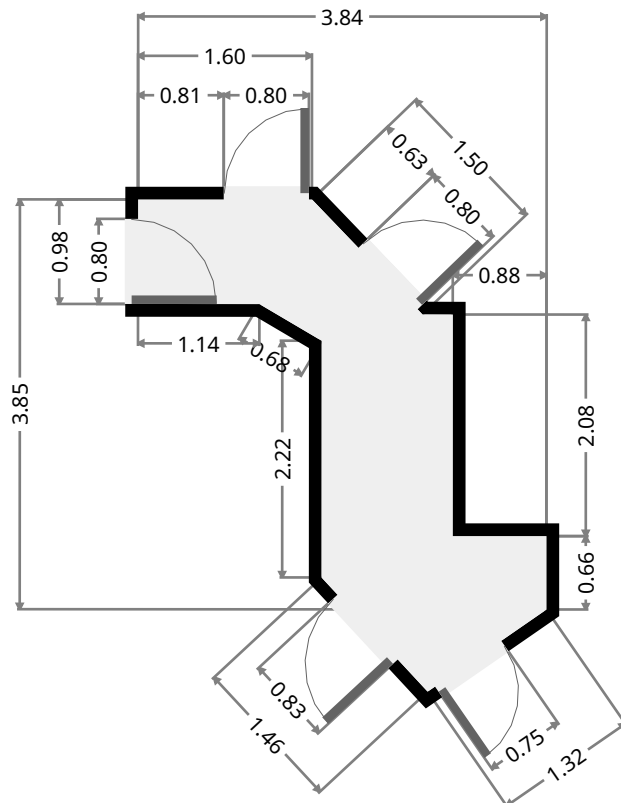
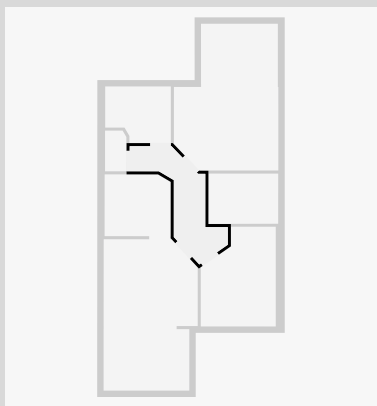

THIS FLOORPLAN IS PROVIDED WITHOUT WARRANTY OF ANY KIND. SENSOPIA DISCLAIMS ANY WARRANTY INCLUDING, WITHOUT LIMITATION, SATISFACTORY QUALITY OR ACCURACY OF DIMENSIONS.

Unit 5/200 Denham Street

Toilet

Width: 0.83 m
Length: 1.59 m
Area: 1.31 m²
Perimeter: 4.74 m

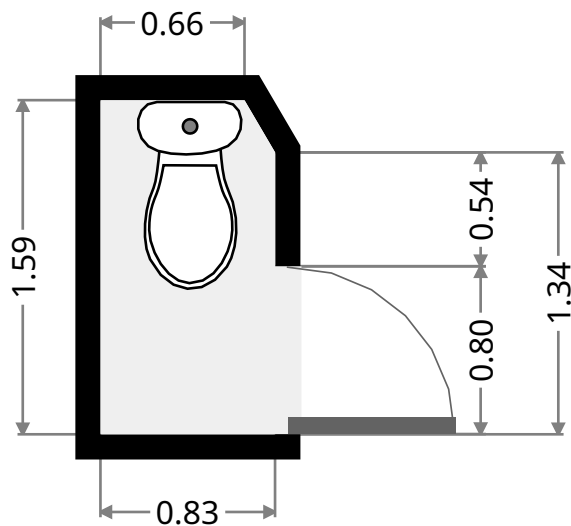
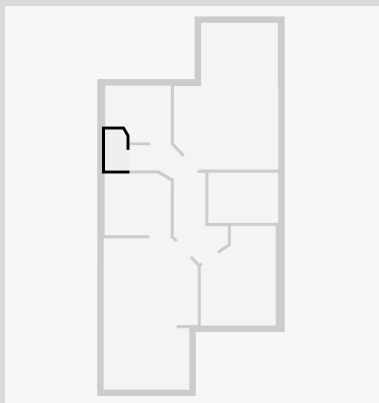

Bathroom

Width: 2.22 m
Length: 2.56 m
Area: 5.14 m²
Perimeter: 9.43 m

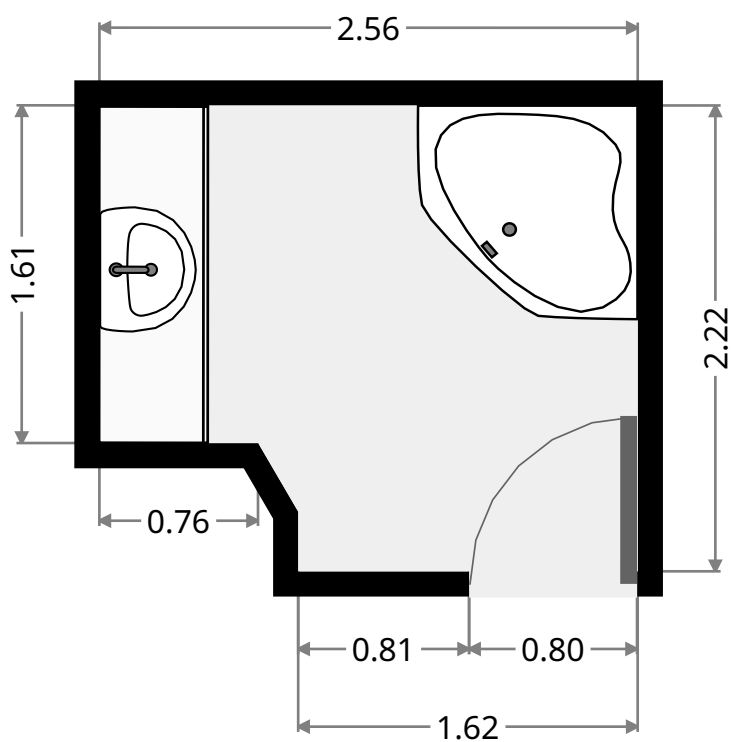
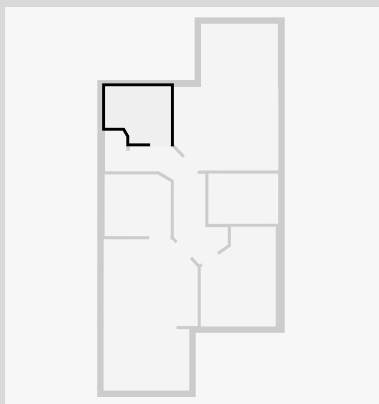

THIS FLOORPLAN IS PROVIDED WITHOUT WARRANTY OF ANY KIND. SENSOPIA DISCLAIMS ANY WARRANTY INCLUDING, WITHOUT LIMITATION, SATISFACTORY QUALITY OR ACCURACY OF DIMENSIONS.

Unit 5/200 Denham Street

Bedroom

Width: 3.26 m
Length: 4.08 m
Area: 12.82 m²
Perimeter: 14.10 m

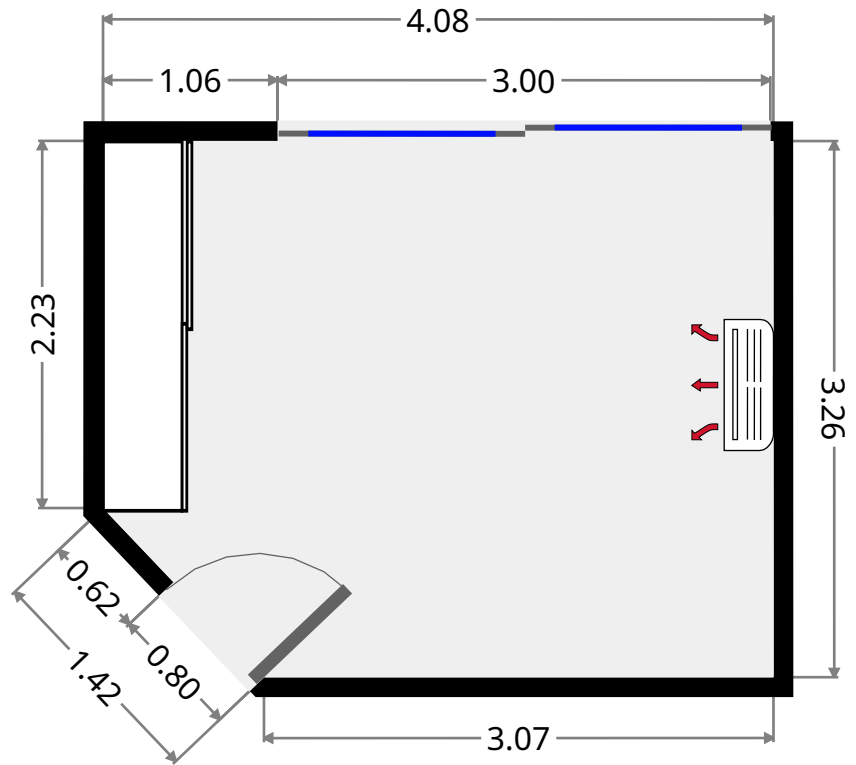
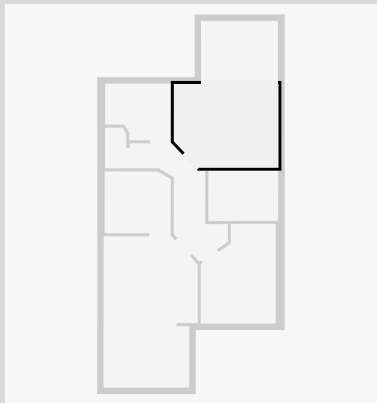

Balcony

Width: 2.35 m
Length: 3.00 m
Area: 7.06 m²
Perimeter: 10.71 m

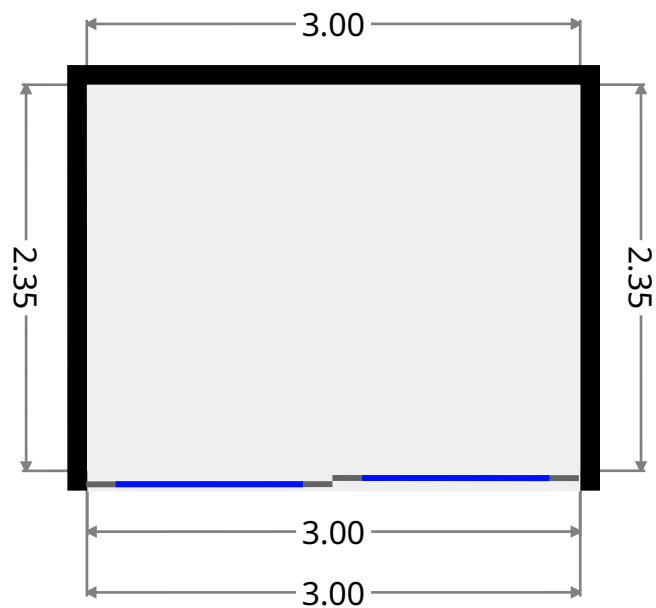
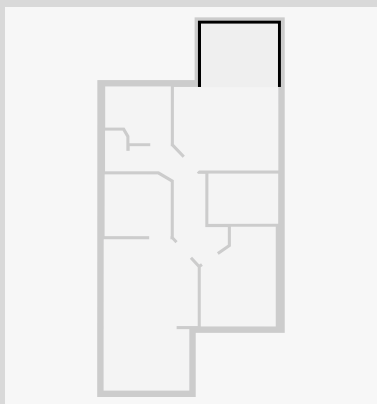

Unit 5/200 Denham Street

Bedroom

Width: 2.93 m
Length: 3.90 m
Area: 10.04 m²
Perimeter: 13.09 m

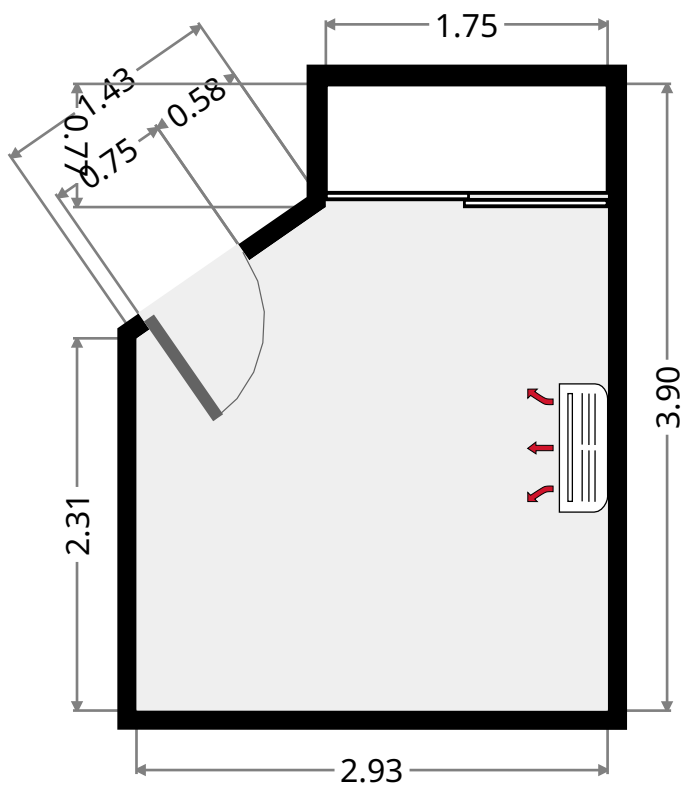
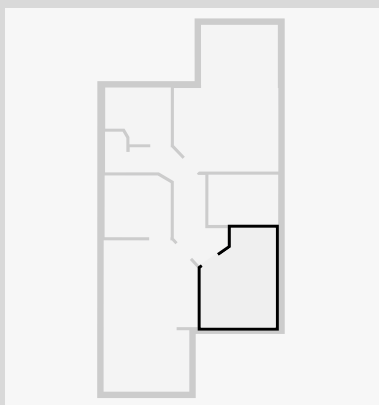

Stairway

Width: 1.97 m
Length: 2.73 m
Area: 5.35 m²
Perimeter: 9.38 m

