

Unit 2/93 Breakspear Street

Ground Floor

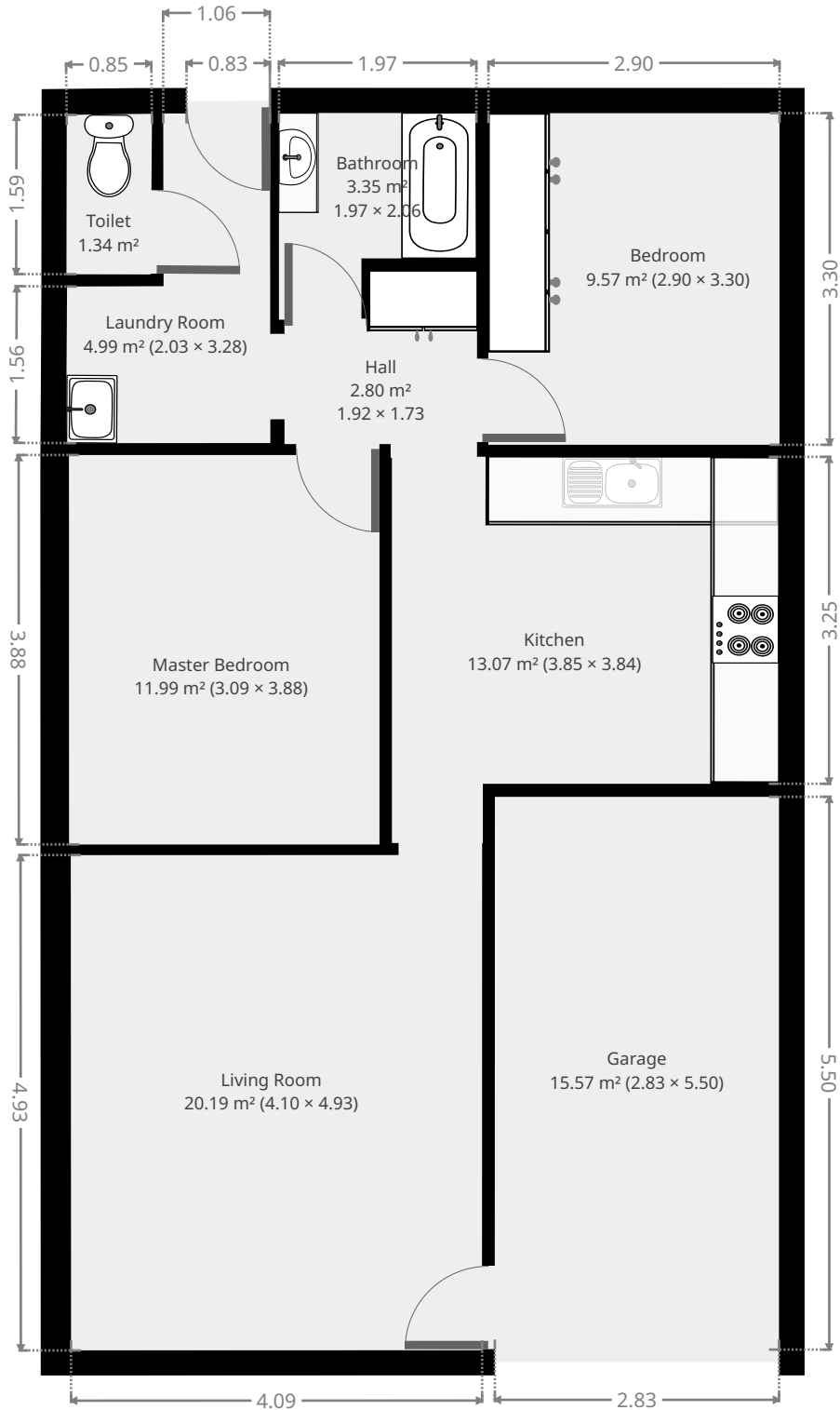

THIS FLOORPLAN IS PROVIDED WITHOUT WARRANTY OF ANY KIND. SENSOPIA DISCLAIMS ANY WARRANTY INCLUDING, WITHOUT LIMITATION, SATISFACTORY QUALITY OR ACCURACY OF DIMENSIONS.

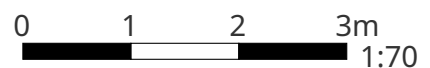

Unit 2/93 Breakspear Street

Living Room

Width: 4.10 m
Length: 4.93 m
Area: 20.19 m²
Perimeter: 18.05 m

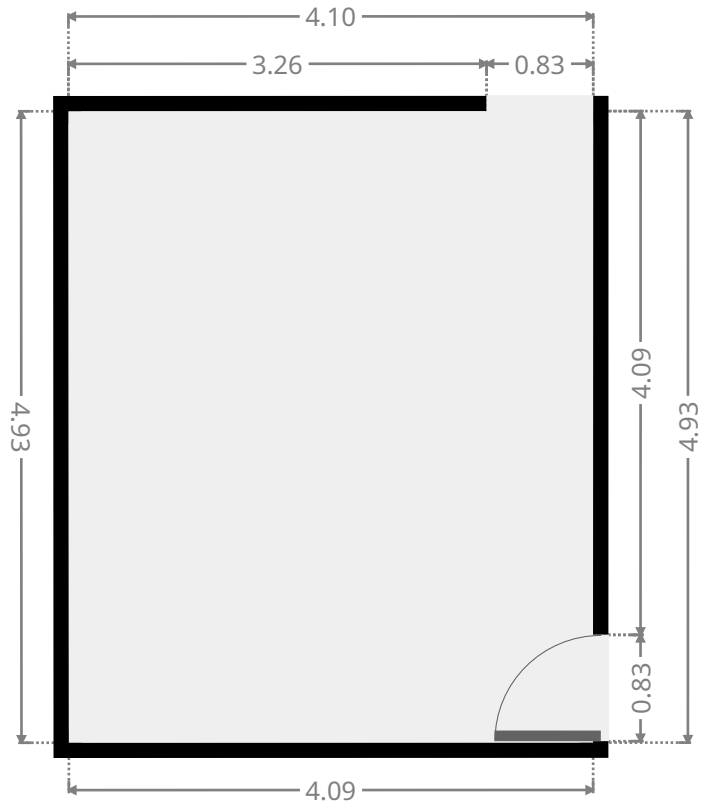
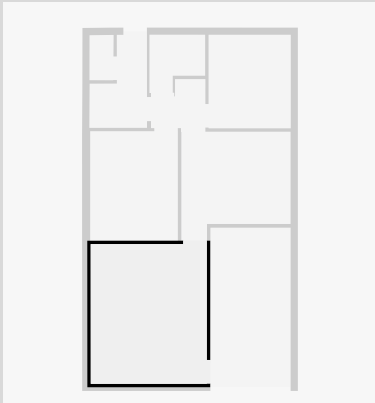

Kitchen

Width: 3.84 m
Length: 3.85 m
Area: 13.07 m²
Perimeter: 15.39 m

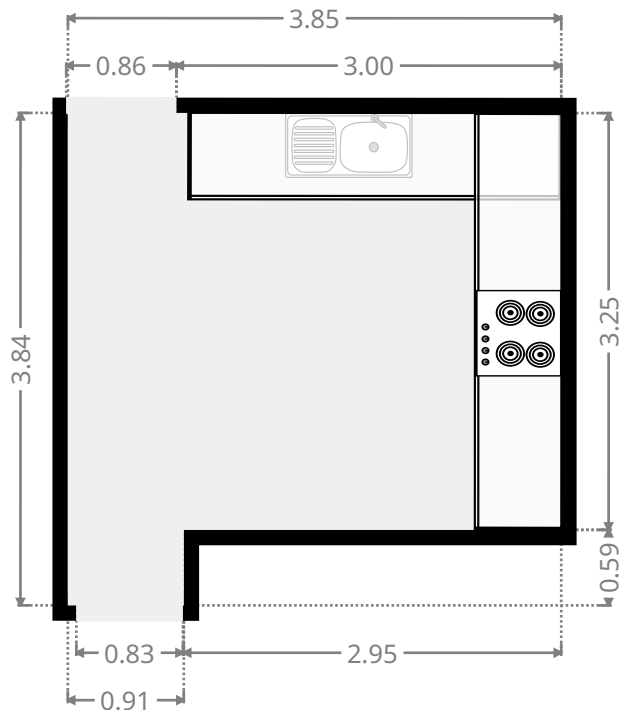
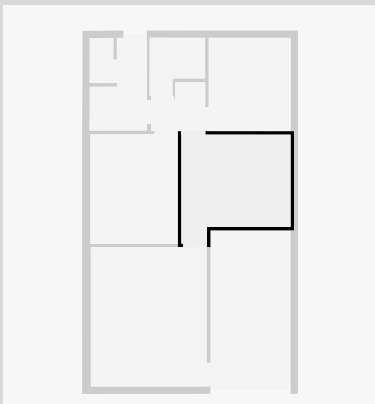

THIS FLOORPLAN IS PROVIDED WITHOUT WARRANTY OF ANY KIND. SENSOPIA DISCLAIMS ANY WARRANTY INCLUDING, WITHOUT LIMITATION, SATISFACTORY QUALITY OR ACCURACY OF DIMENSIONS.

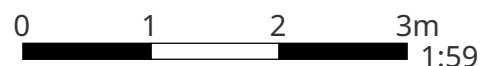

Unit 2/93 Breakspear Street

Hall

Width: 1.73 m
 Length: 1.92 m
 Area: 2.80 m²
 Perimeter: 7.29 m

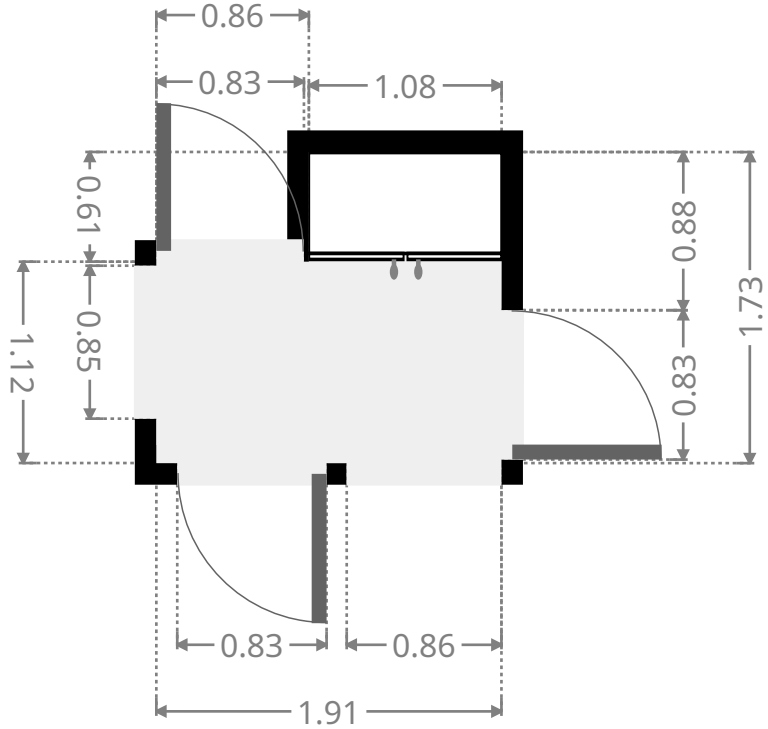
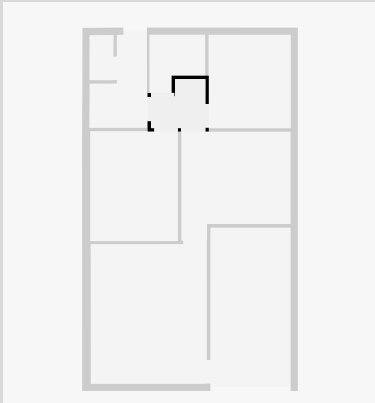

Bedroom

Width: 2.90 m
 Length: 3.30 m
 Area: 9.57 m²
 Perimeter: 12.40 m

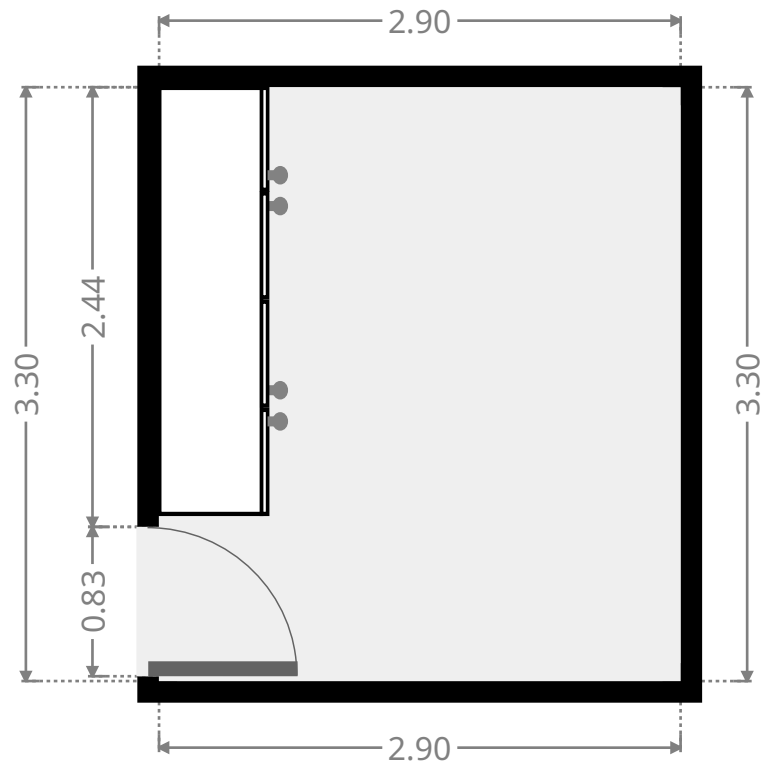
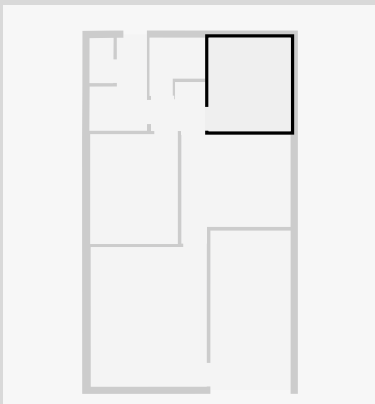

THIS FLOORPLAN IS PROVIDED WITHOUT WARRANTY OF ANY KIND. SENSOPIA DISCLAIMS ANY WARRANTY INCLUDING, WITHOUT LIMITATION, SATISFACTORY QUALITY OR ACCURACY OF DIMENSIONS.

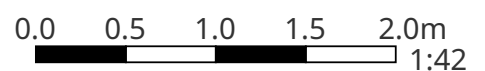

Unit 2/93 Breakspear Street

Bathroom

Width: 1.97 m
Length: 2.06 m
Area: 3.35 m²
Perimeter: 8.05 m

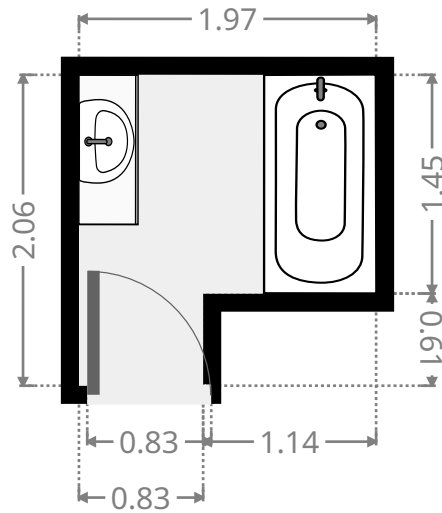
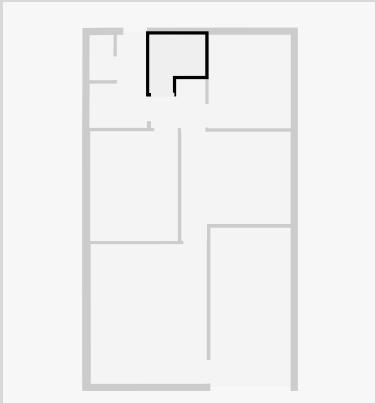

Master Bedroom

Width: 3.09 m
Length: 3.88 m
Area: 11.99 m²
Perimeter: 13.94 m

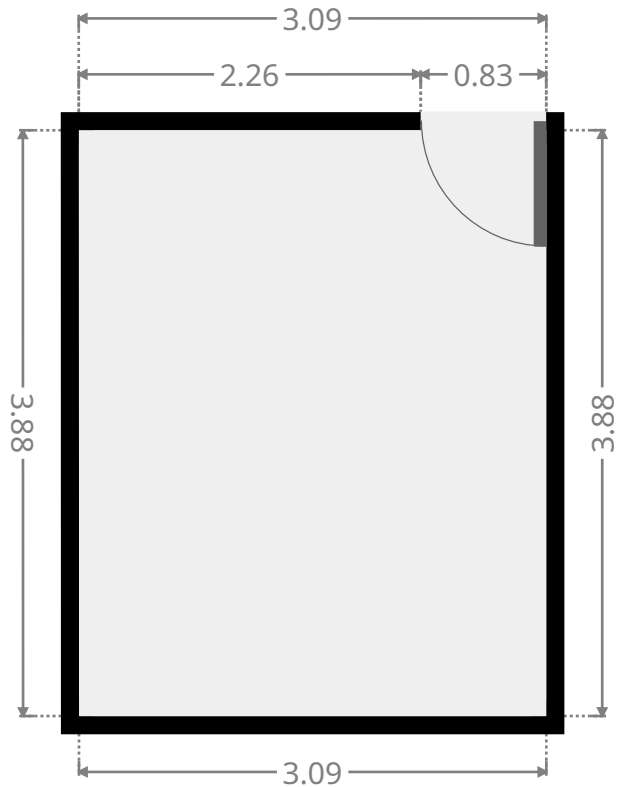
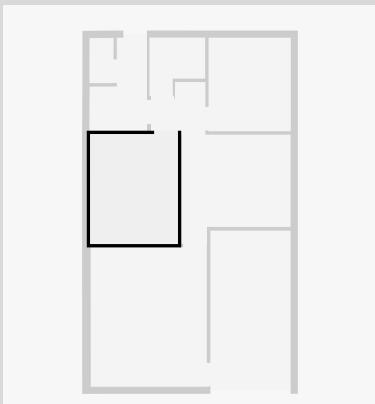

Unit 2/93 Breakspear Street

Laundry Room

Width: 2.03 m
 Length: 3.28 m
 Area: 4.99 m²
 Perimeter: 10.62 m

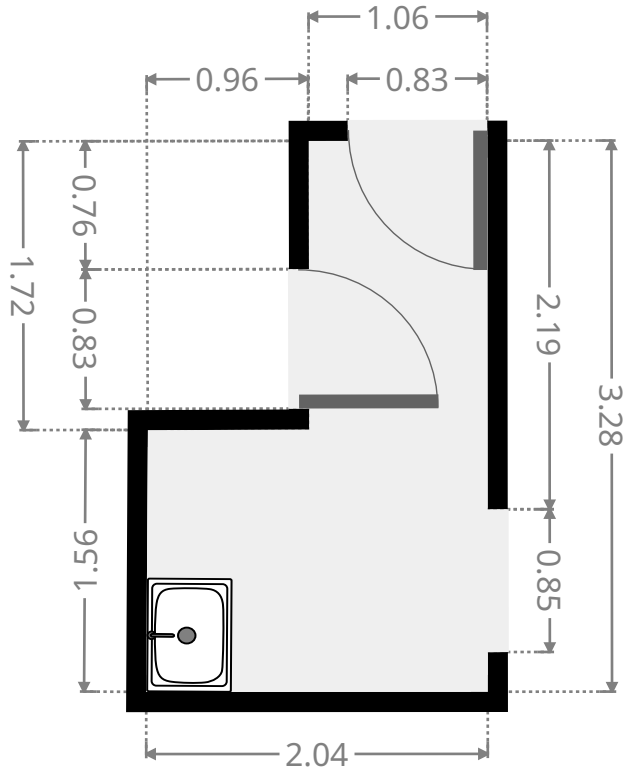
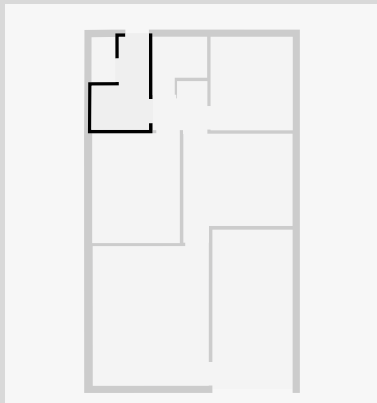

Toilet / Half Bath

Width: 0.85 m
 Length: 1.60 m
 Area: 1.34 m²
 Perimeter: 4.87 m

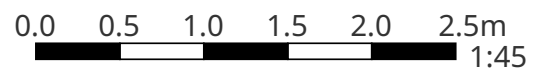
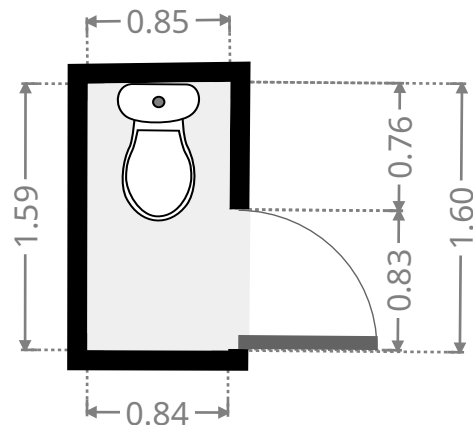
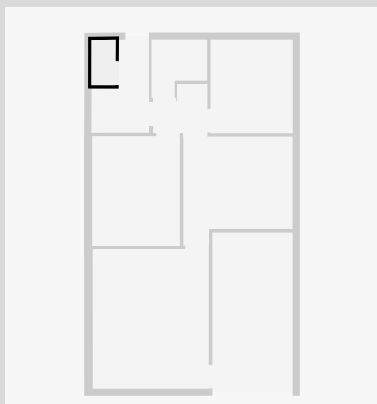

Unit 2/93 Breakspear Street

Garage

Width: 2.83 m
Length: 5.50 m
Area: 15.57 m²
Perimeter: 16.66 m

