

Unit 2/339 Richardson Road

Ground Floor

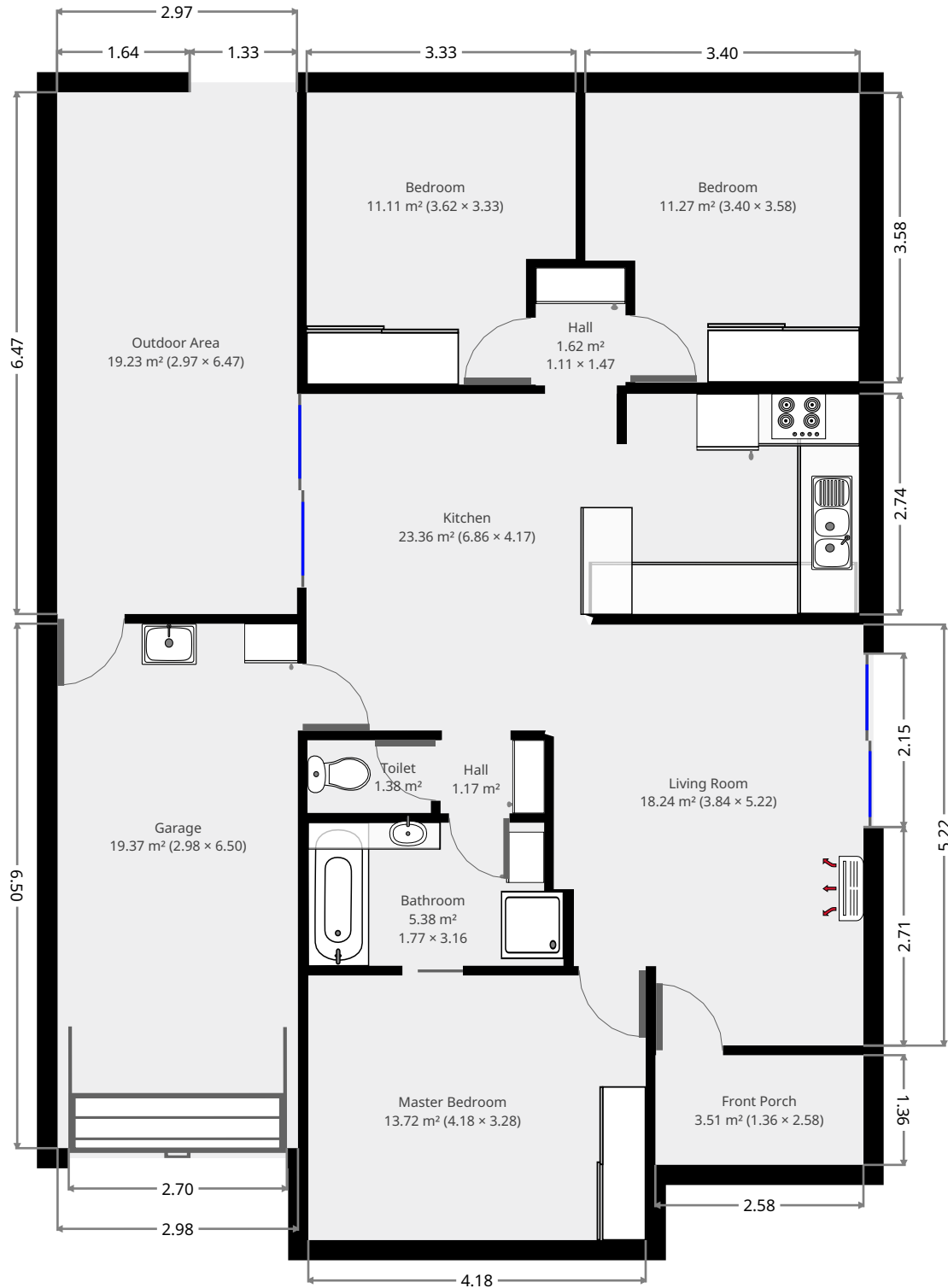

THIS FLOORPLAN IS PROVIDED WITHOUT WARRANTY OF ANY KIND. SENSOPIA DISCLAIMS ANY WARRANTY INCLUDING, WITHOUT LIMITATION, SATISFACTORY QUALITY OR ACCURACY OF DIMENSIONS.



Unit 2/339 Richardson Road

Living Room

Width: 3.84 m
 Length: 5.22 m
 Area: 18.24 m²
 Perimeter: 17.75 m

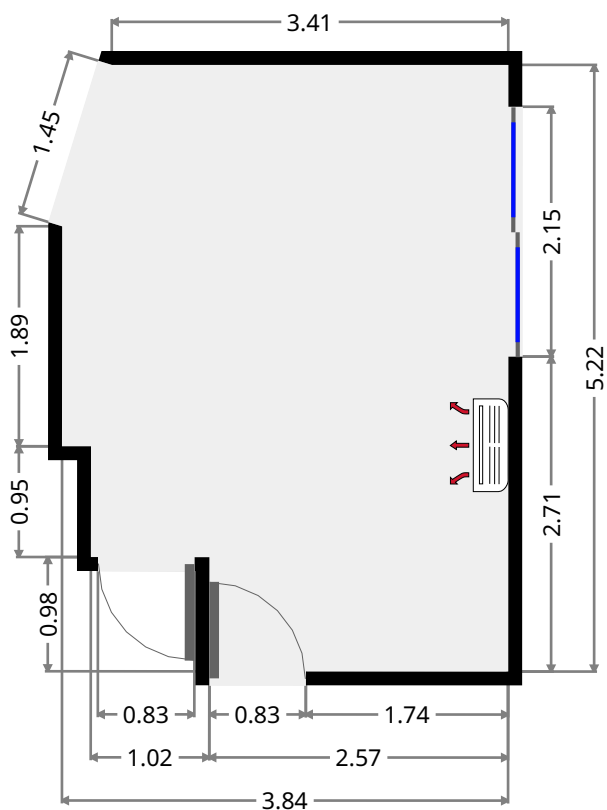
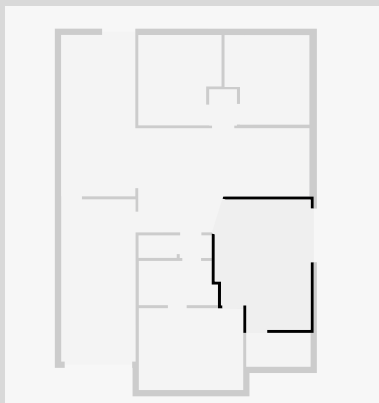

Master Bedroom

Width: 3.28 m
 Length: 4.18 m
 Area: 13.72 m²
 Perimeter: 14.92 m

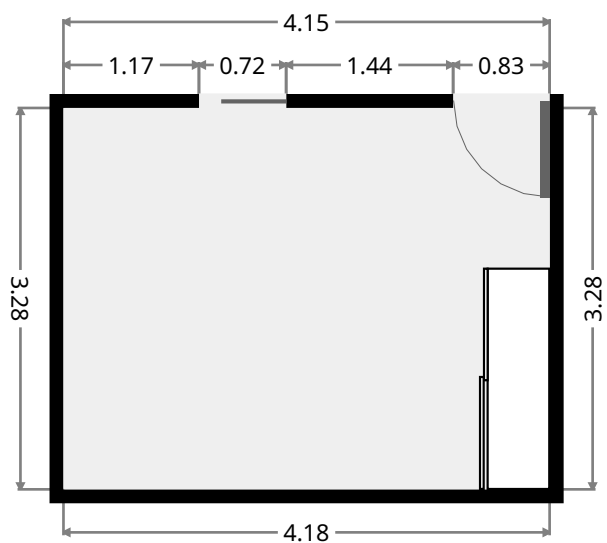
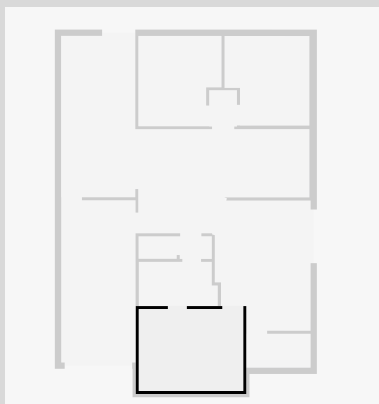

Unit 2/339 Richardson Road

Bathroom

Width: 1.77 m
 Length: 3.16 m
 Area: 5.38 m²
 Perimeter: 9.87 m

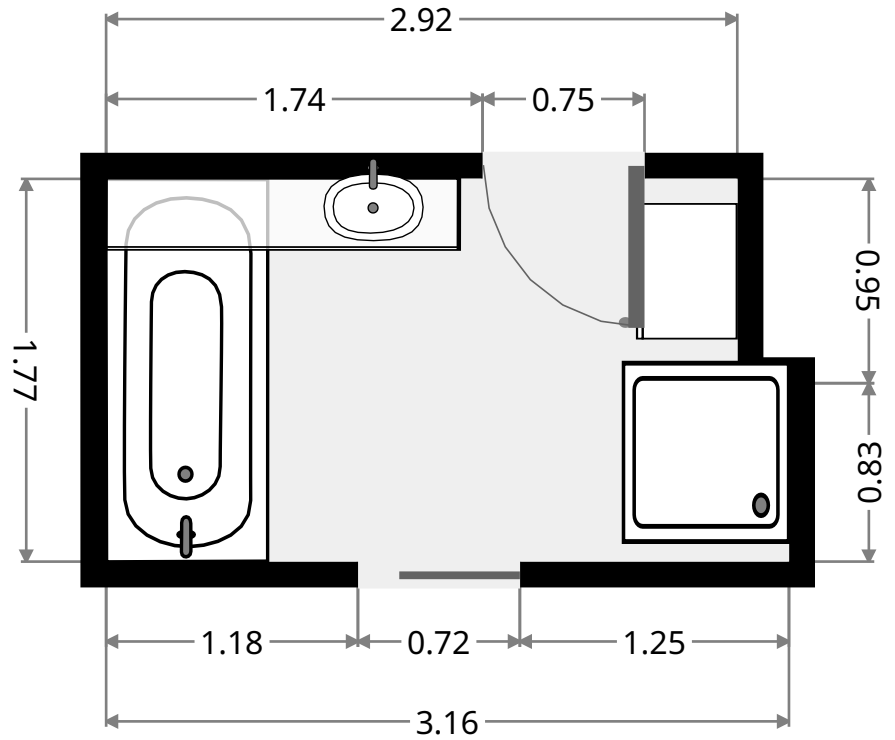
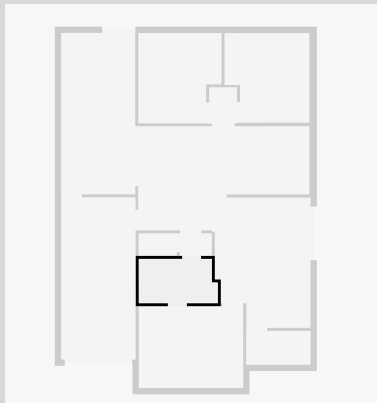

Hall

Width: 0.91 m
 Length: 1.29 m
 Area: 1.17 m²
 Perimeter: 4.39 m

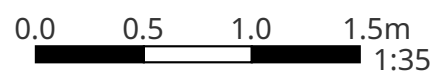
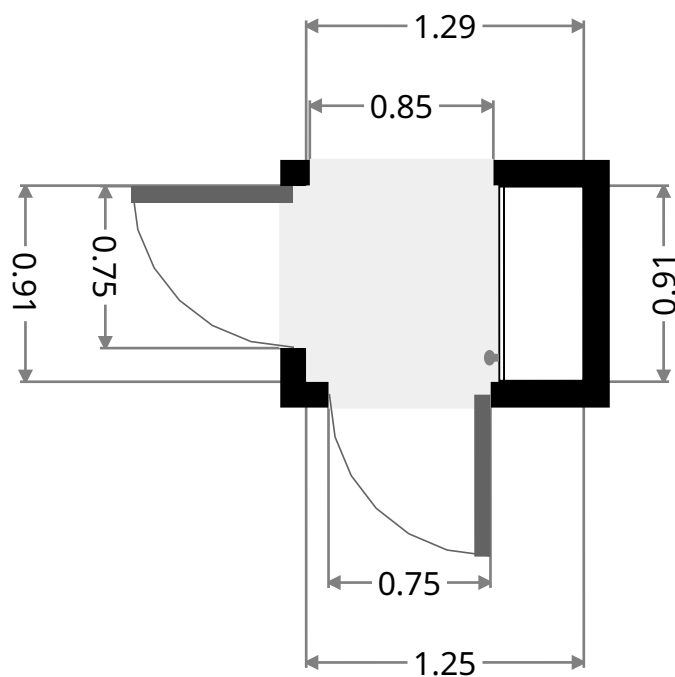
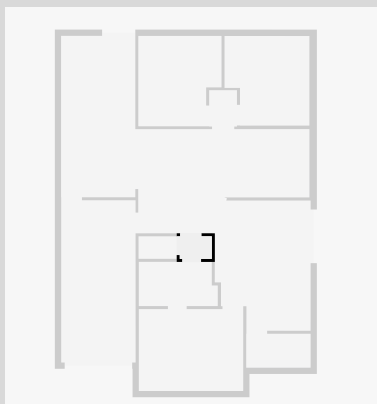

Unit 2/339 Richardson Road

Toilet

Width: 0.90 m
Length: 1.53 m
Area: 1.38 m²
Perimeter: 4.86 m

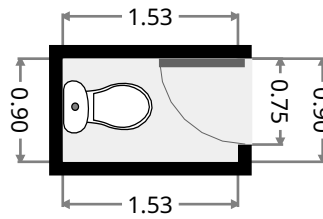
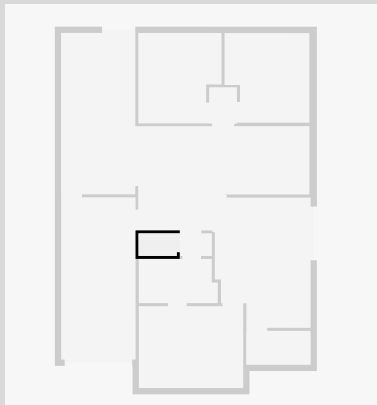

Kitchen

Width: 4.17 m
Length: 6.86 m
Area: 23.36 m²
Perimeter: 21.67 m

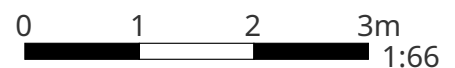
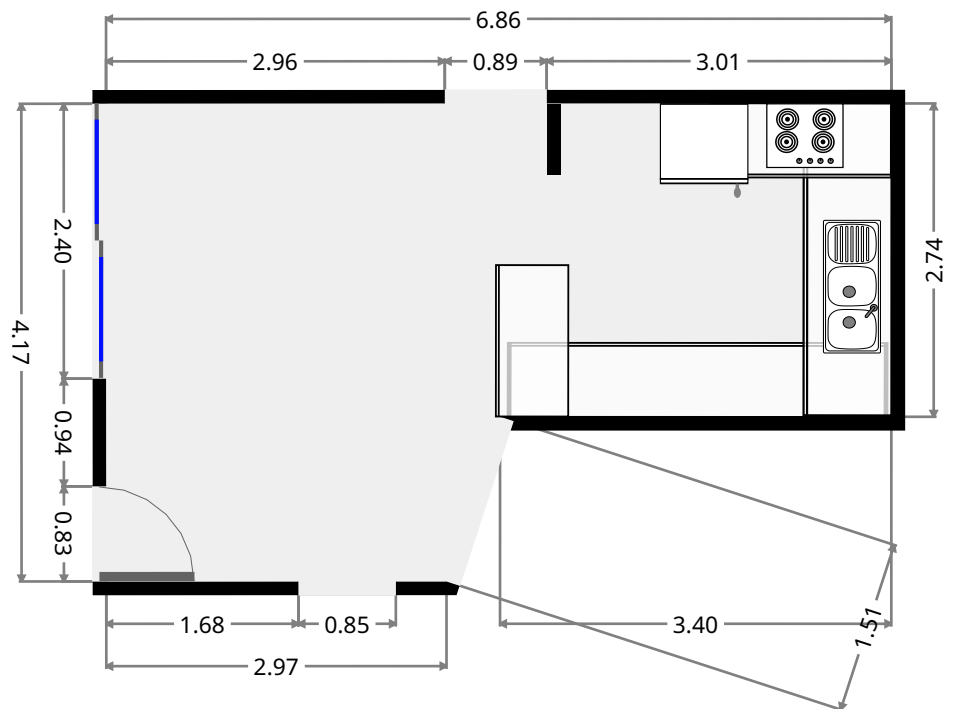
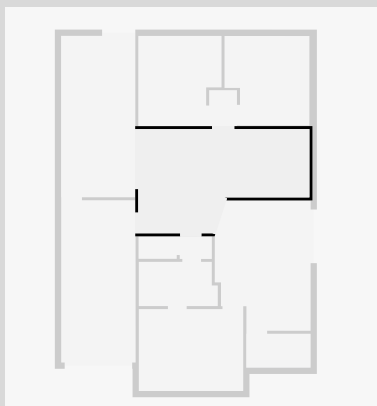

THIS FLOORPLAN IS PROVIDED WITHOUT WARRANTY OF ANY KIND. SENSOPIA DISCLAIMS ANY WARRANTY INCLUDING, WITHOUT LIMITATION, SATISFACTORY QUALITY OR ACCURACY OF DIMENSIONS.

Unit 2/339 Richardson Road

Hall

Width: 1.11 m
 Length: 1.47 m
 Area: 1.62 m²
 Perimeter: 5.14 m

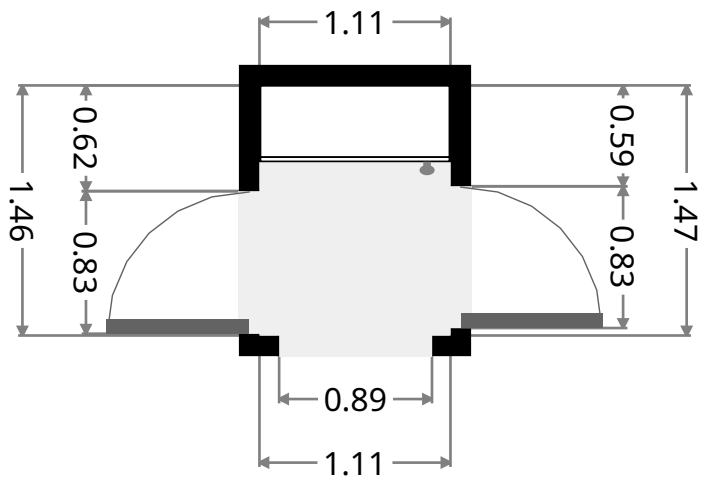
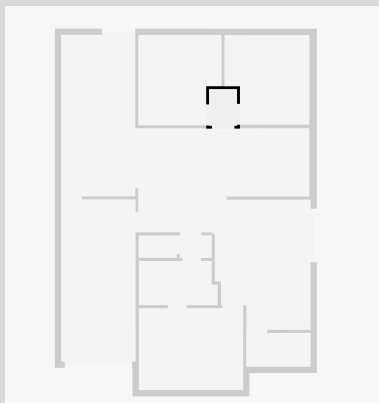

Bedroom

Width: 3.40 m
 Length: 3.58 m
 Area: 11.27 m²
 Perimeter: 13.98 m

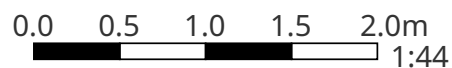
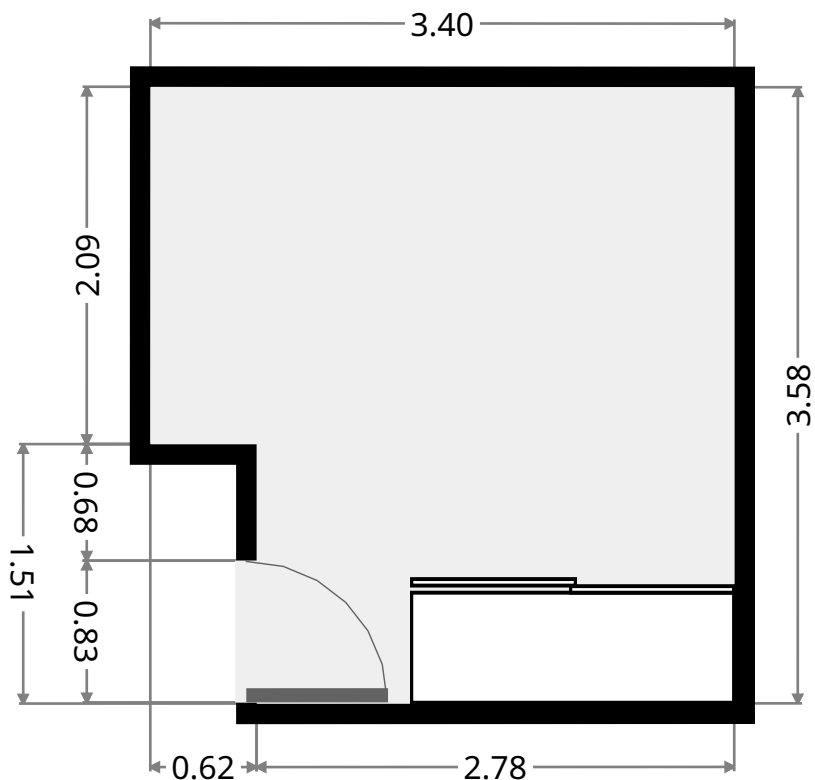
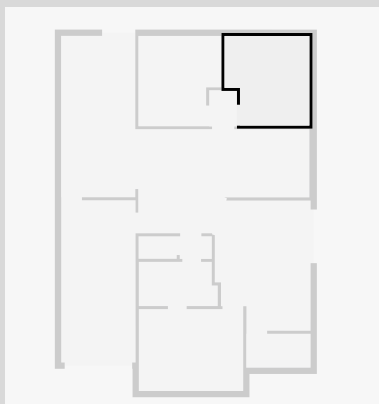

THIS FLOORPLAN IS PROVIDED WITHOUT WARRANTY OF ANY KIND. SENSOPIA DISCLAIMS ANY WARRANTY INCLUDING, WITHOUT LIMITATION, SATISFACTORY QUALITY OR ACCURACY OF DIMENSIONS.

Unit 2/339 Richardson Road

Bedroom

Width: 3.33 m
Length: 3.62 m
Area: 11.11 m²
Perimeter: 13.91 m

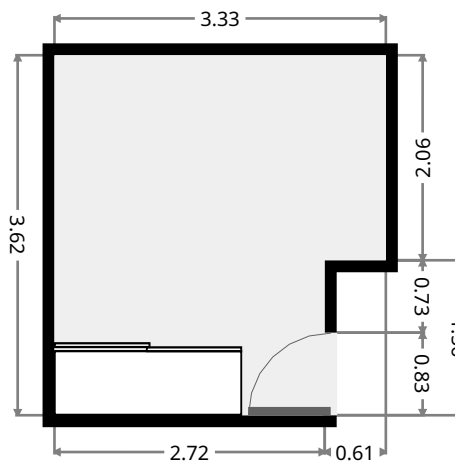
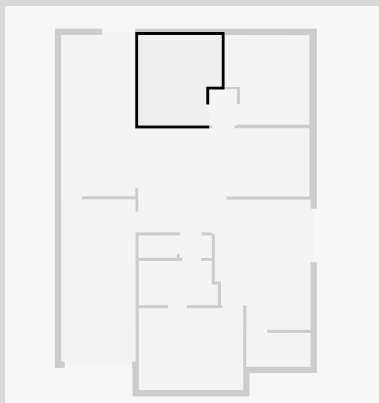

Garage

Width: 2.98 m
Length: 6.50 m
Area: 19.37 m²
Perimeter: 18.96 m

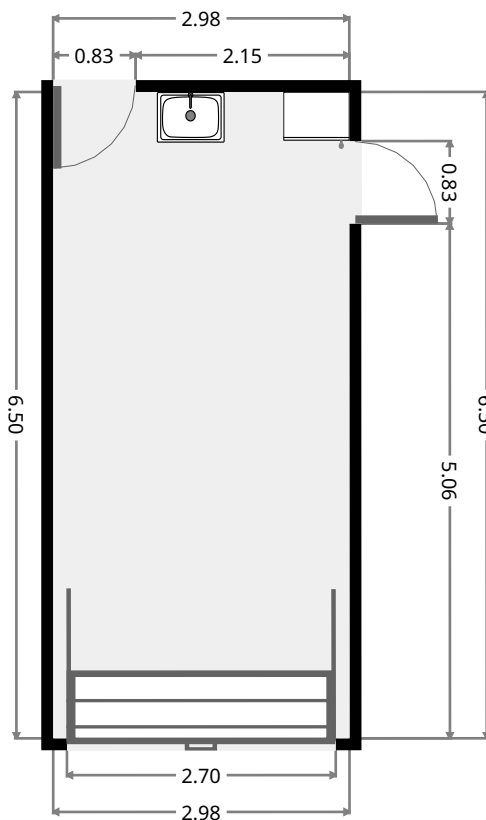
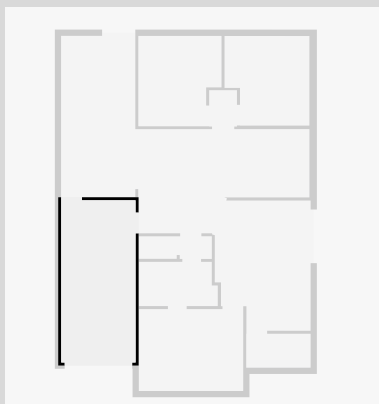

THIS FLOORPLAN IS PROVIDED WITHOUT WARRANTY OF ANY KIND. SENSOPIA DISCLAIMS ANY WARRANTY INCLUDING, WITHOUT LIMITATION, SATISFACTORY QUALITY OR ACCURACY OF DIMENSIONS.

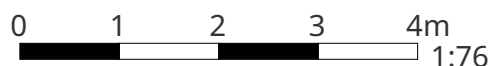

Unit 2/339 Richardson Road

Outdoor Area

Width: 2.97 m
 Length: 6.47 m
 Area: 19.23 m²
 Perimeter: 18.88 m

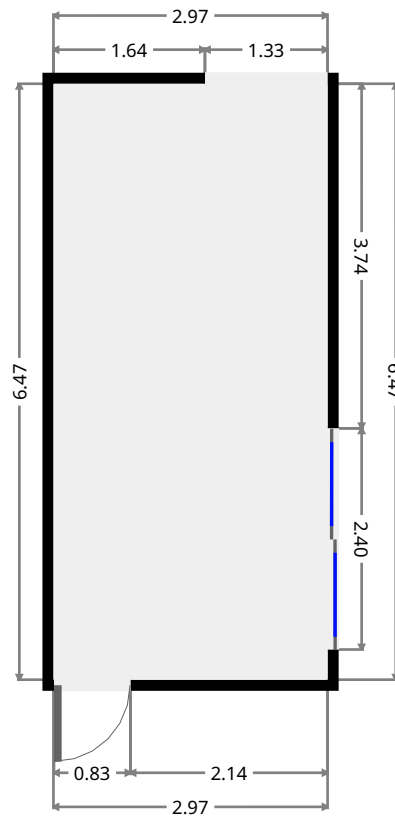
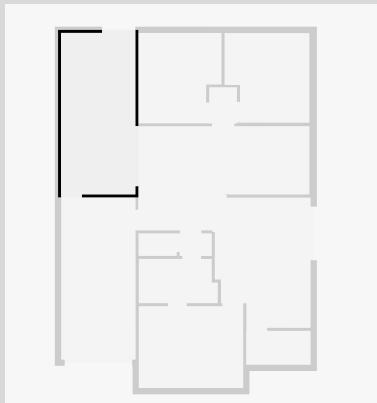

Front Porch

Width: 1.36 m
 Length: 2.58 m
 Area: 3.51 m²
 Perimeter: 7.88 m

