

# Unit 2/21 Price Avenue

Created on  
2020-08-11

Floors  
1

▼ Ground Floor

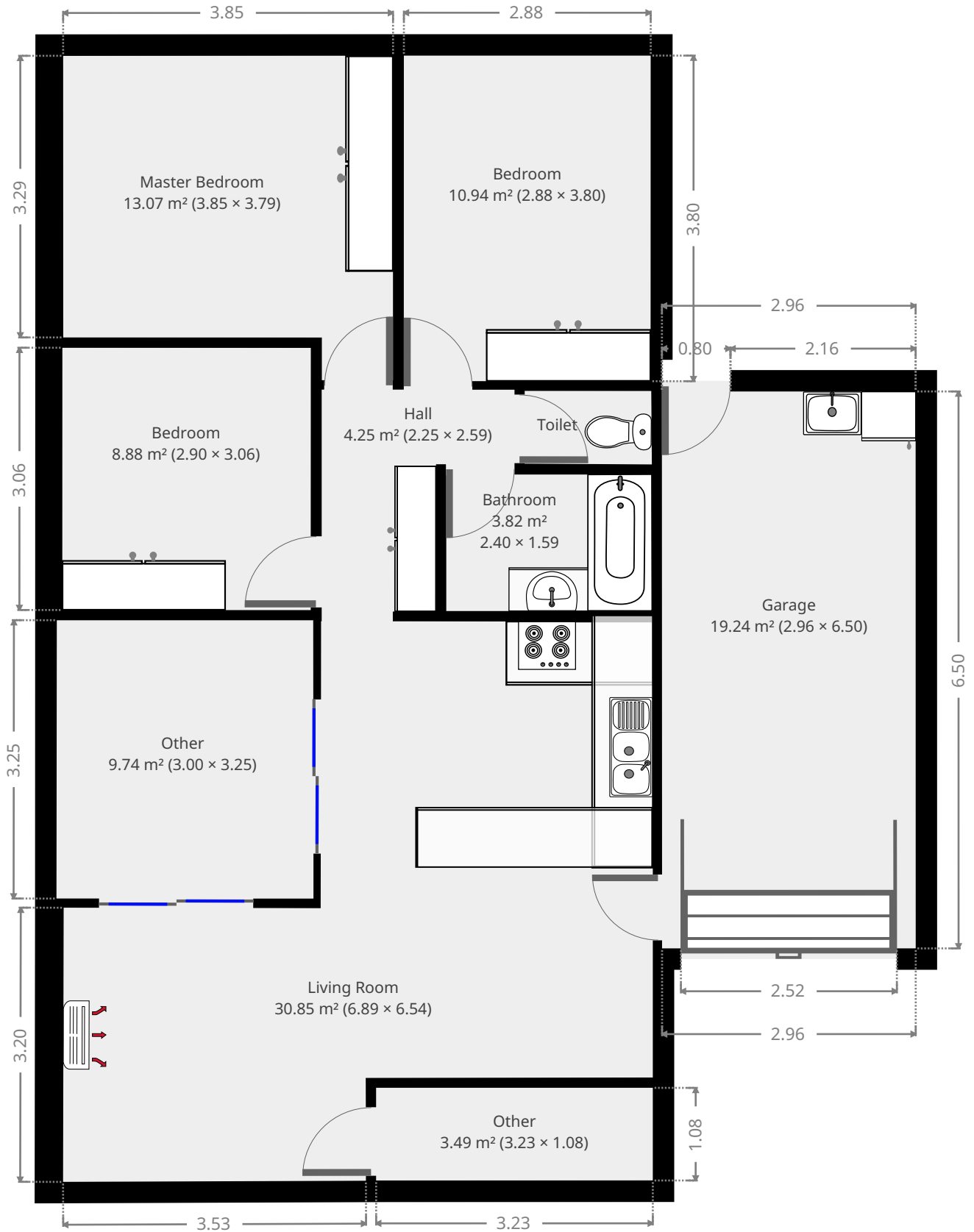

▼ **Living Room**  
Ground Floor

WIDTH: 6.89 m • LENGTH: 6.54 m  
AREA: 30.85 m<sup>2</sup> • PERIMETER: 26.82 m

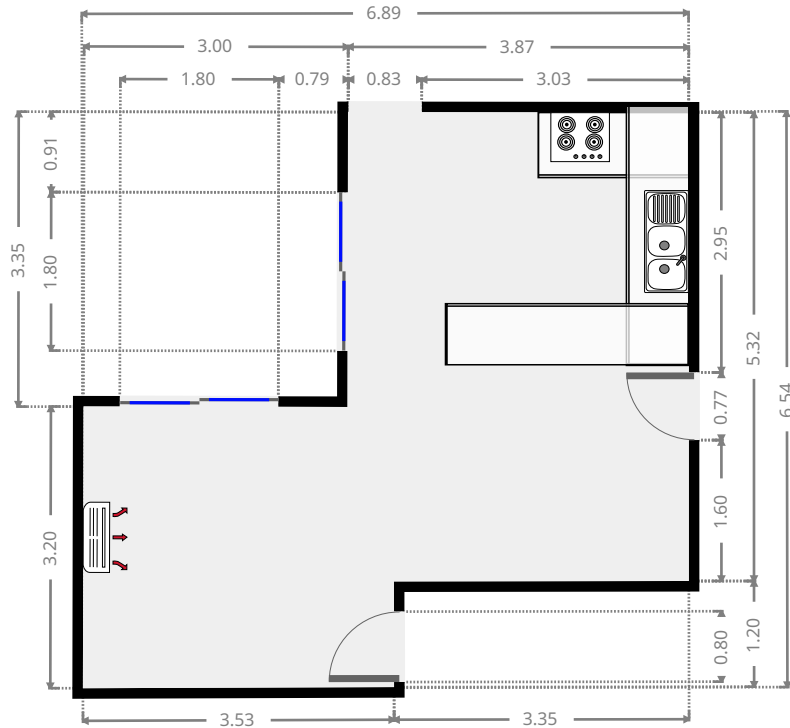
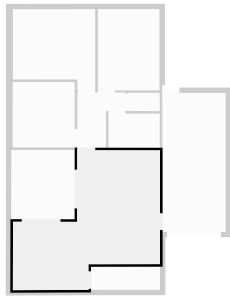

▼ **Hall**  
Ground Floor

WIDTH: 2.25 m • LENGTH: 2.59 m  
AREA: 4.25 m<sup>2</sup> • PERIMETER: 9.68 m

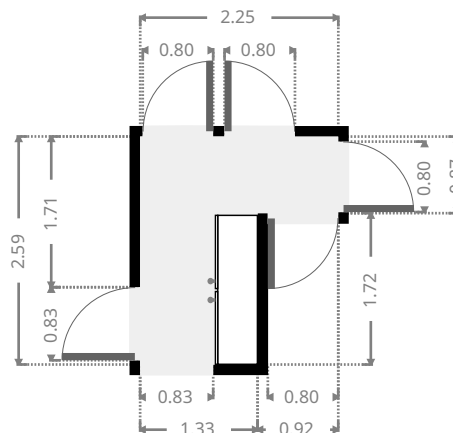
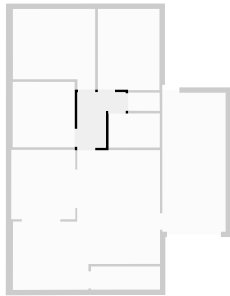

FLOORS: 1

▼ **Other**  
Ground Floor

WIDTH: 3.00 m • LENGTH: 3.25 m  
AREA: 9.74 m<sup>2</sup> • PERIMETER: 12.49 m

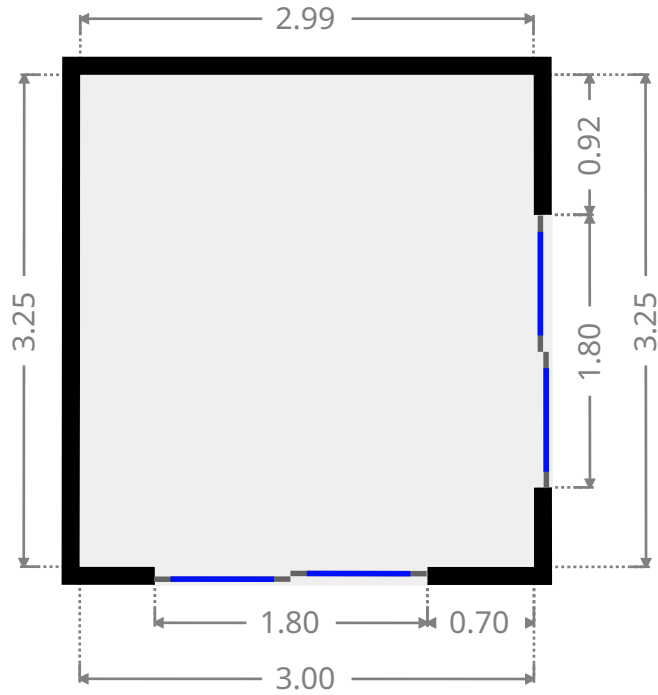
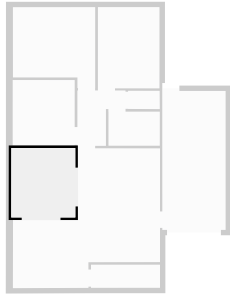

▼ **Bedroom**  
Ground Floor

WIDTH: 2.90 m • LENGTH: 3.06 m  
AREA: 8.88 m<sup>2</sup> • PERIMETER: 11.92 m

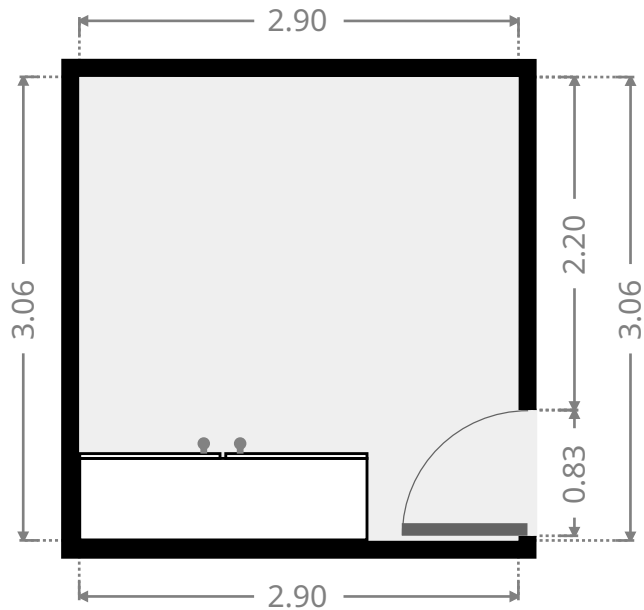
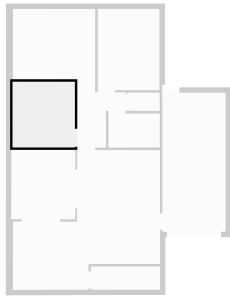

▼ **Master Bedroom**  
Ground Floor

WIDTH: 3.85 m • LENGTH: 3.79 m  
AREA: 13.07 m<sup>2</sup> • PERIMETER: 15.27 m

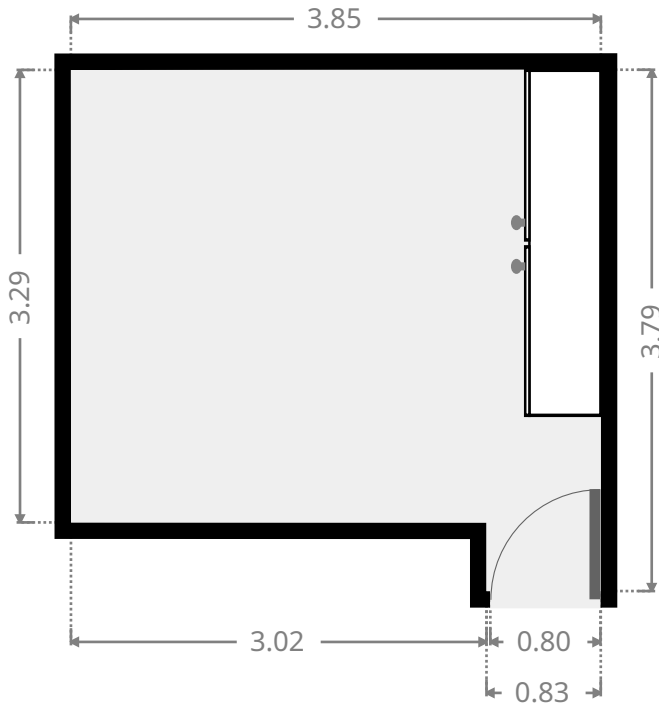
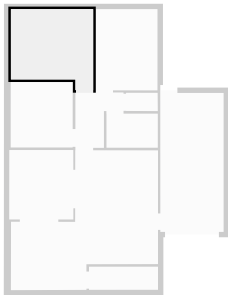

▼ **Bedroom**  
Ground Floor

WIDTH: 2.88 m • LENGTH: 3.80 m  
AREA: 10.94 m<sup>2</sup> • PERIMETER: 13.36 m

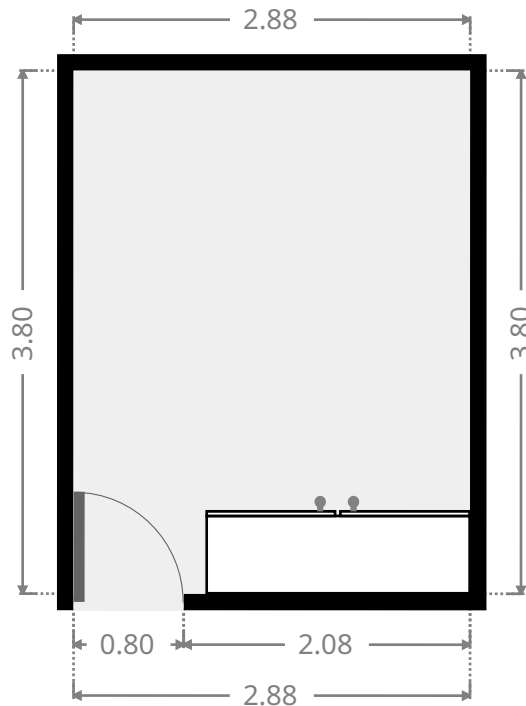
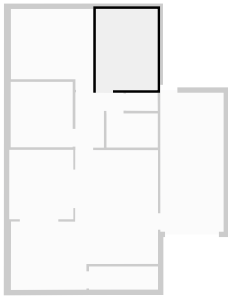

FLOORS: 1

▼ **Toilet**  
Ground Floor

WIDTH: 1.48 m • LENGTH: 0.87 m  
AREA: 1.26 m<sup>2</sup> • PERIMETER: 4.67 m

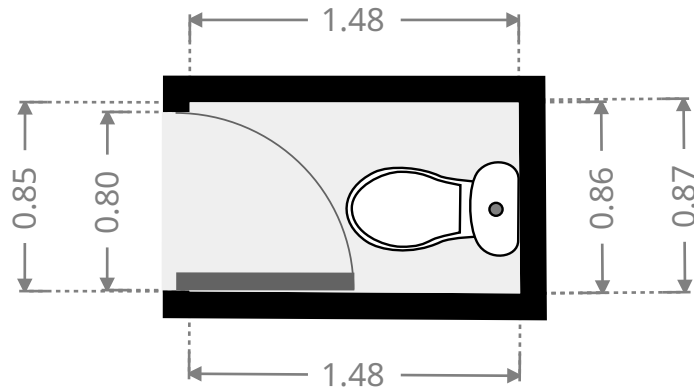
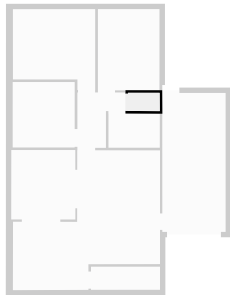

▼ **Bathroom**  
Ground Floor

WIDTH: 2.40 m • LENGTH: 1.59 m  
AREA: 3.82 m<sup>2</sup> • PERIMETER: 7.99 m

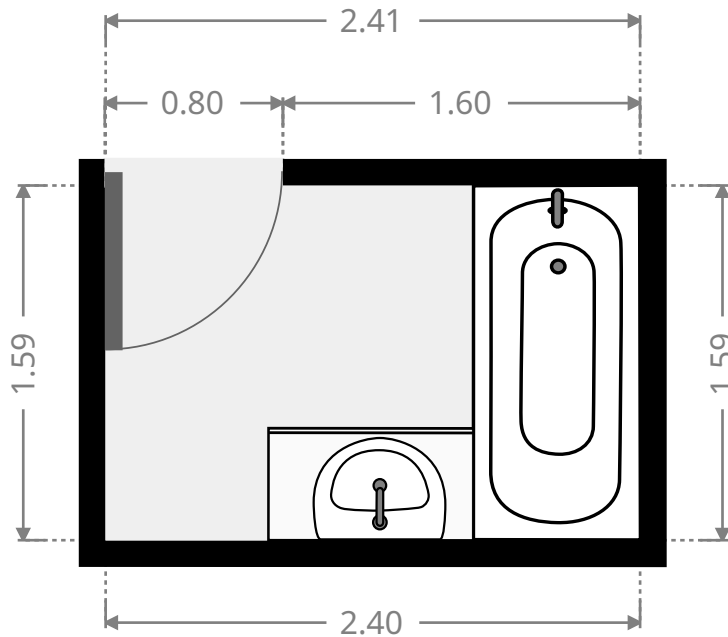
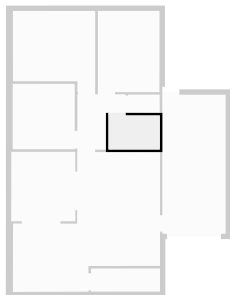

FLOORS: 1

▼ **Garage**  
Ground Floor

**WIDTH:** 2.96 m • **LENGTH:** 6.50 m  
**AREA:** 19.24 m<sup>2</sup> • **PERIMETER:** 18.92 m

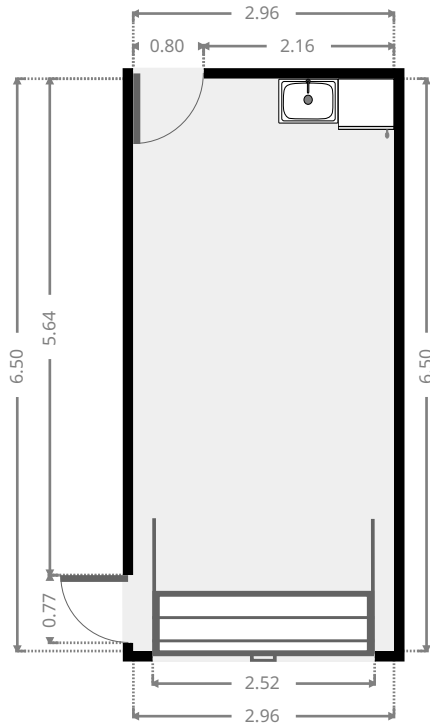
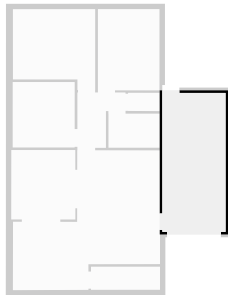

▼ **Other**  
Ground Floor

**WIDTH:** 3.23 m • **LENGTH:** 1.08 m  
**AREA:** 3.49 m<sup>2</sup> • **PERIMETER:** 8.62 m

