

# Unit 2/182 Talford Street

## Ground Floor

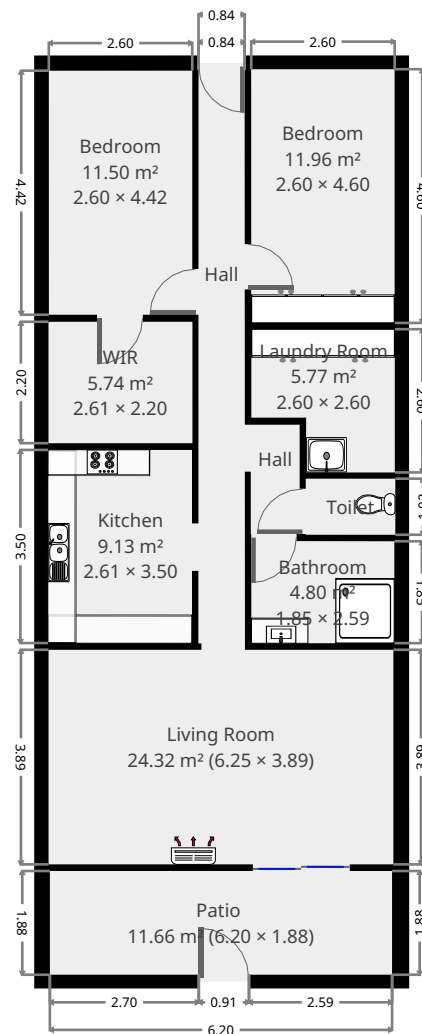

THIS FLOORPLAN IS PROVIDED WITHOUT WARRANTY OF ANY KIND. SENSOPIA DISCLAIMS ANY WARRANTY INCLUDING, WITHOUT LIMITATION, SATISFACTORY QUALITY OR ACCURACY OF DIMENSIONS.

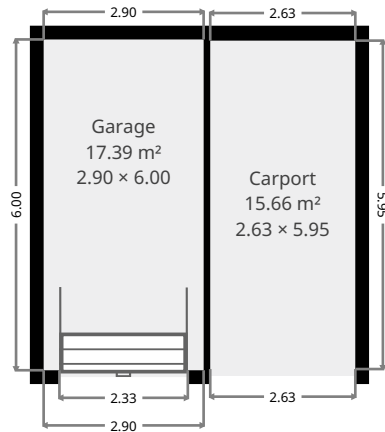

# Unit 2/182 Talford Street

## Living Room

Width: 3.89 m  
 Length: 6.25 m  
 Area: 24.32 m<sup>2</sup>  
 Perimeter: 20.28 m

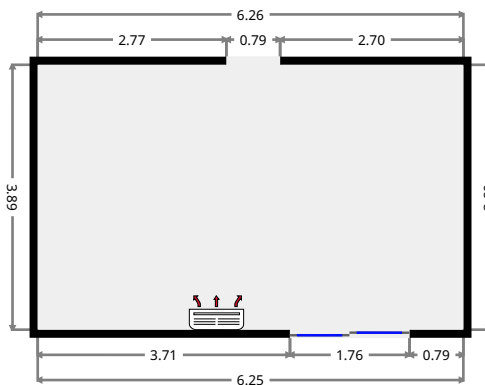
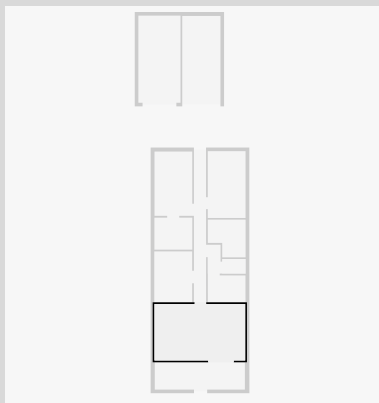

## Hall

Width: 0.84 m  
 Length: 10.40 m  
 Area: 8.74 m<sup>2</sup>  
 Perimeter: 22.48 m

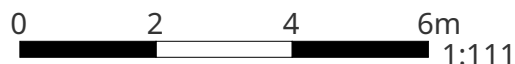
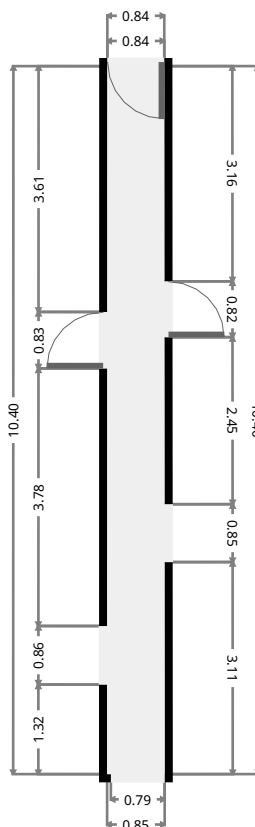
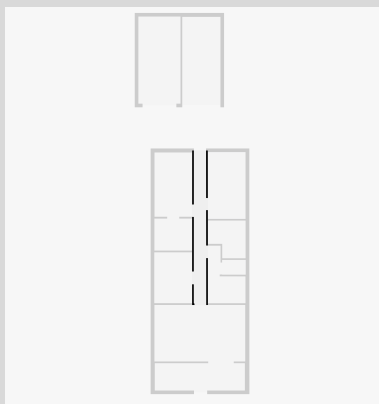

# Unit 2/182 Talford Street

## Kitchen

Width: 2.61 m  
 Length: 3.50 m  
 Area: 9.13 m<sup>2</sup>  
 Perimeter: 12.22 m

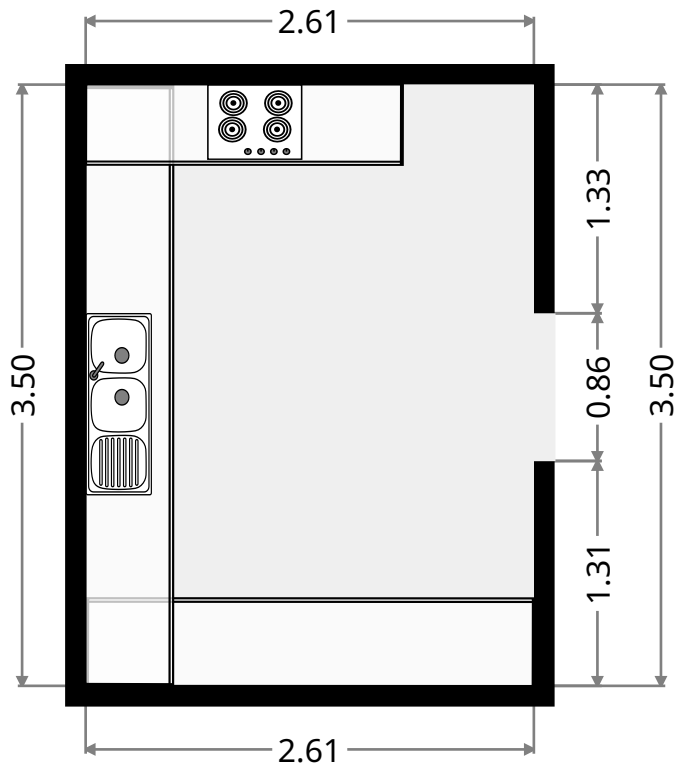
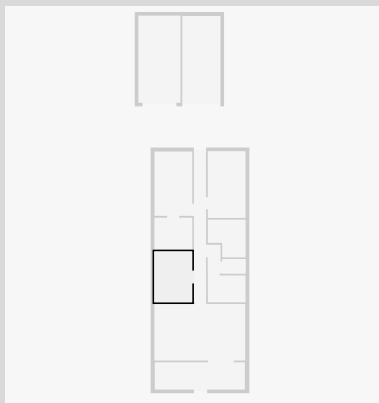

## WIR

Width: 2.20 m  
 Length: 2.61 m  
 Area: 5.74 m<sup>2</sup>  
 Perimeter: 9.62 m

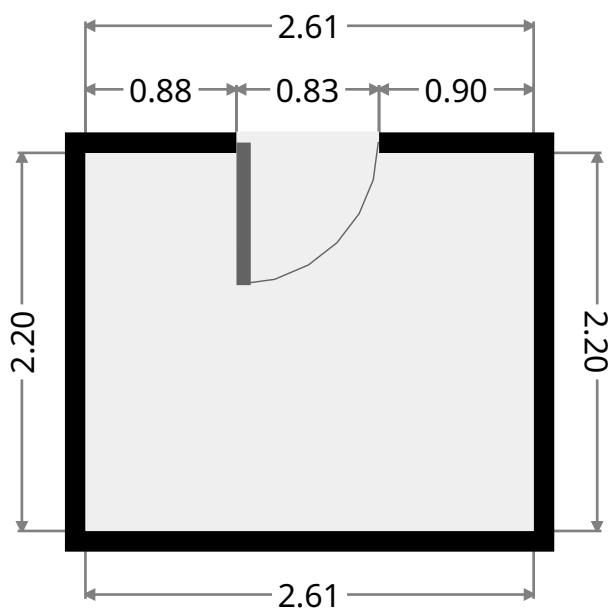
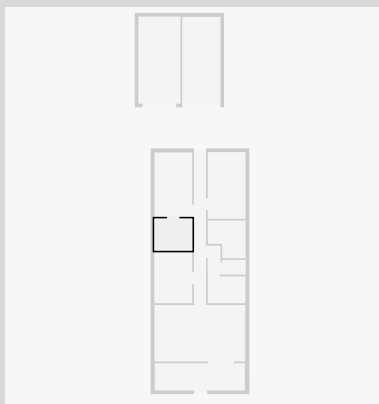

THIS FLOORPLAN IS PROVIDED WITHOUT WARRANTY OF ANY KIND. SENSOPIA DISCLAIMS ANY WARRANTY INCLUDING, WITHOUT LIMITATION, SATISFACTORY QUALITY OR ACCURACY OF DIMENSIONS.

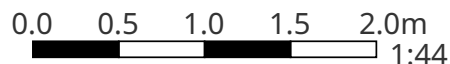

# Unit 2/182 Talford Street

## Bedroom

Width: 2.60 m  
 Length: 4.42 m  
 Area: 11.50 m<sup>2</sup>  
 Perimeter: 14.05 m

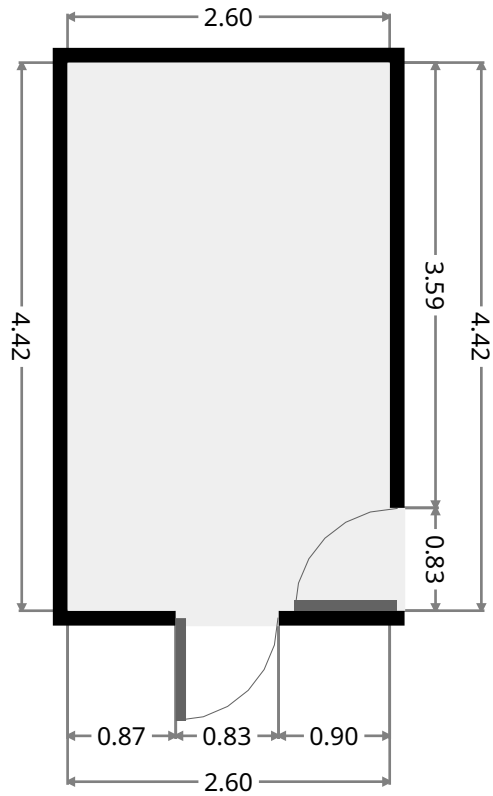
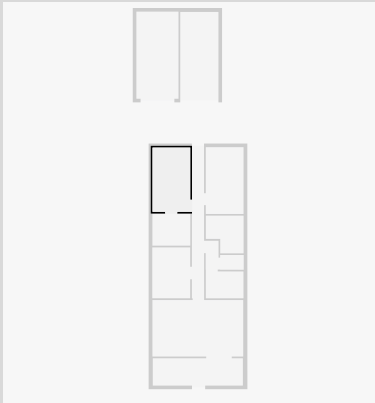

## Bedroom

Width: 2.60 m  
 Length: 4.60 m  
 Area: 11.96 m<sup>2</sup>  
 Perimeter: 14.40 m

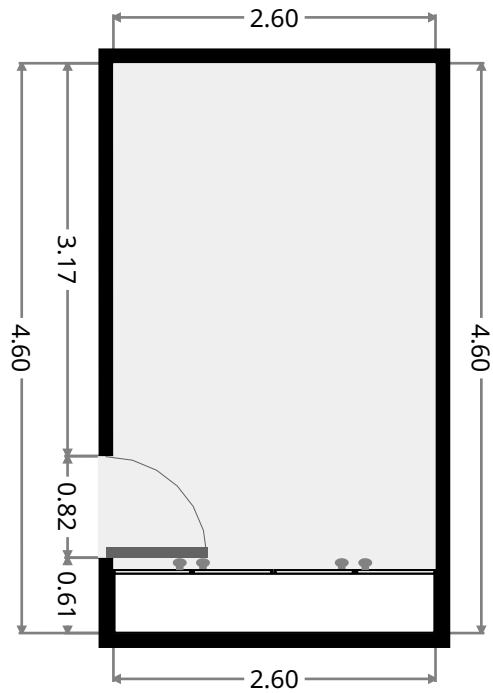
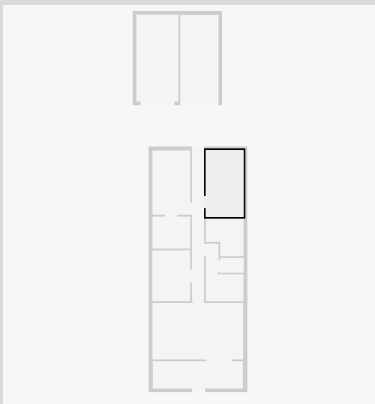

THIS FLOORPLAN IS PROVIDED WITHOUT WARRANTY OF ANY KIND. SENSOPIA DISCLAIMS ANY WARRANTY INCLUDING, WITHOUT LIMITATION, SATISFACTORY QUALITY OR ACCURACY OF DIMENSIONS.

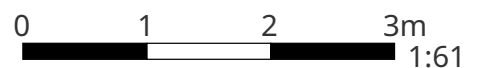

# Unit 2/182 Talford Street

## Laundry Room

Width: 2.60 m  
 Length: 2.60 m  
 Area: 5.77 m<sup>2</sup>  
 Perimeter: 10.39 m

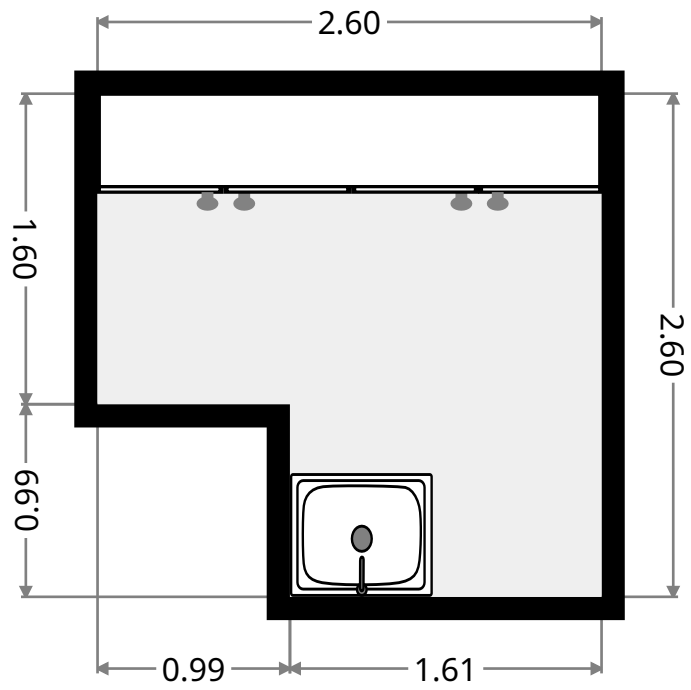
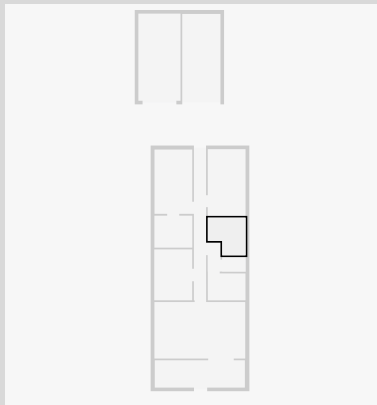

## Hall

Width: 0.89 m  
 Length: 1.98 m  
 Area: 1.76 m<sup>2</sup>  
 Perimeter: 5.74 m

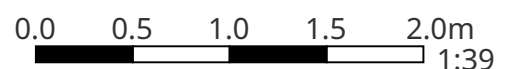
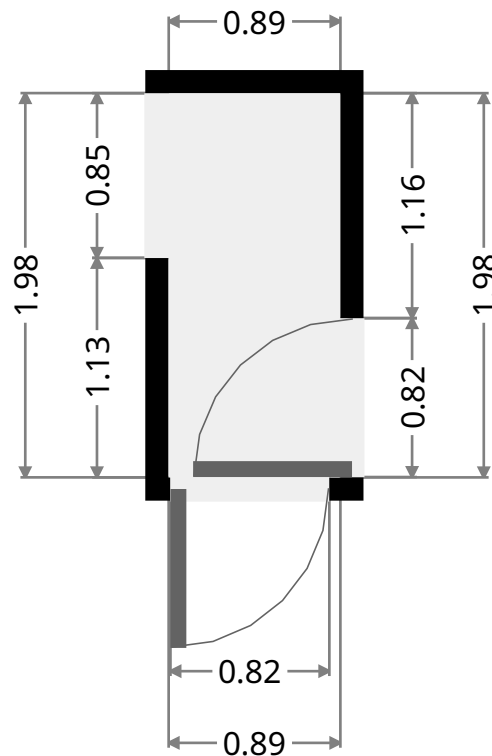
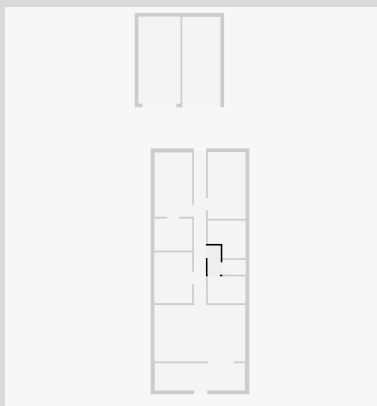

# Unit 2/182 Talford Street

## Toilet

Width: 1.02 m  
Length: 1.62 m  
Area: 1.65 m<sup>2</sup>  
Perimeter: 5.28 m

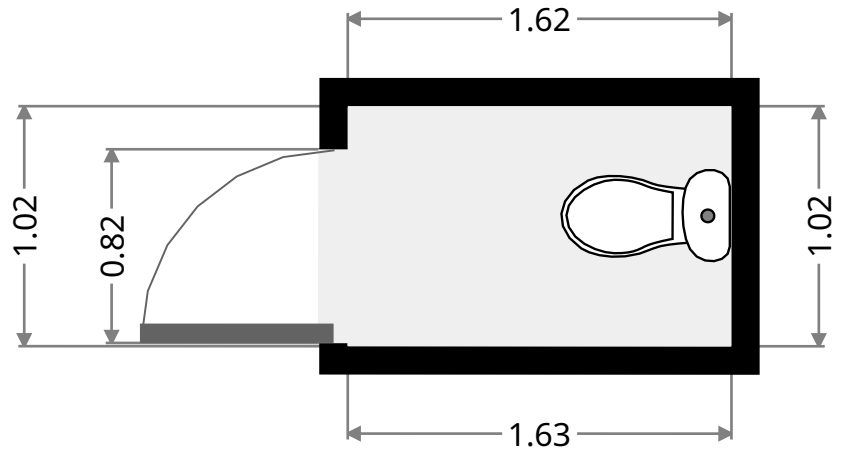
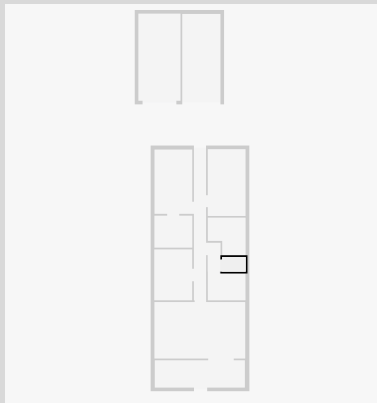

## Bathroom

Width: 1.85 m  
Length: 2.59 m  
Area: 4.80 m<sup>2</sup>  
Perimeter: 8.89 m

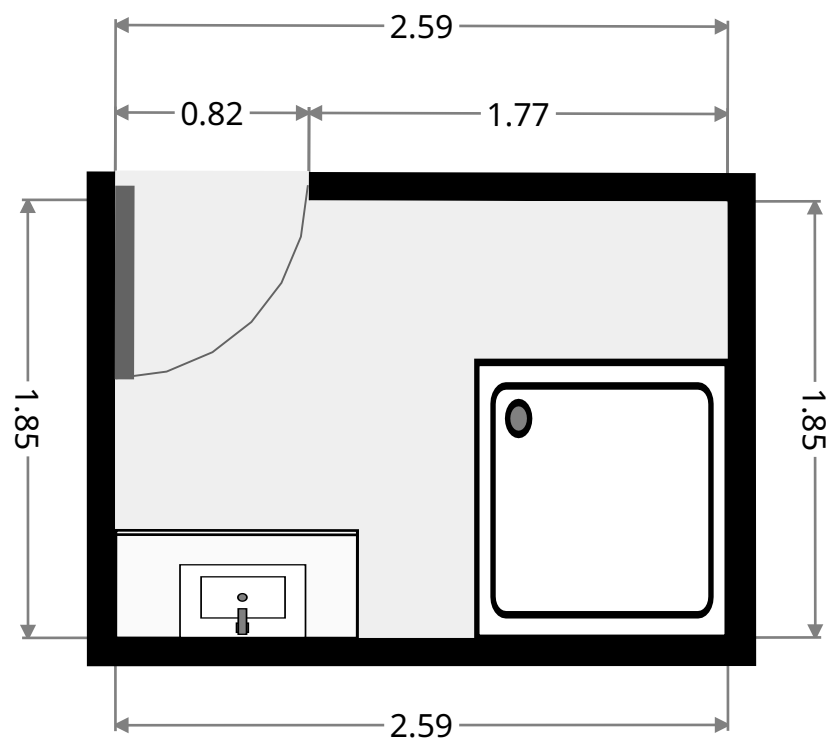
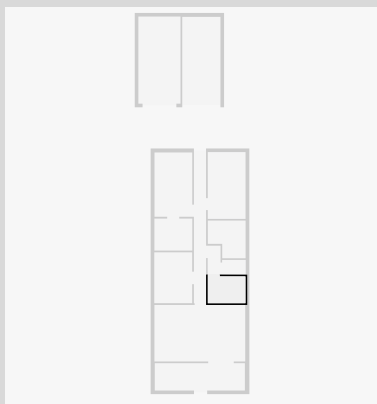

THIS FLOORPLAN IS PROVIDED WITHOUT WARRANTY OF ANY KIND. SENSOPIA DISCLAIMS ANY WARRANTY INCLUDING, WITHOUT LIMITATION, SATISFACTORY QUALITY OR ACCURACY OF DIMENSIONS.

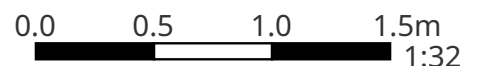

# Unit 2/182 Talford Street

## Patio

Width: 1.88 m  
Length: 6.20 m  
Area: 11.66 m<sup>2</sup>  
Perimeter: 16.17 m

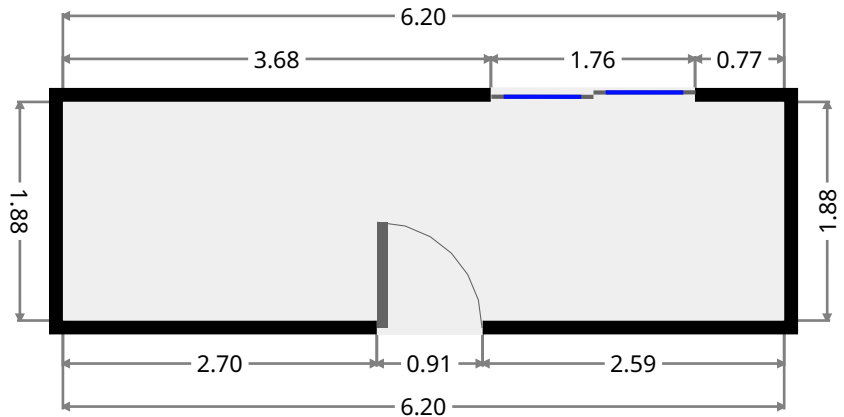
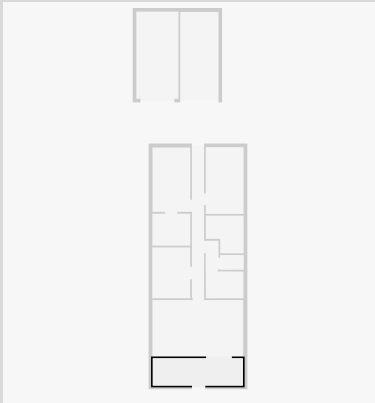

## Carport

Width: 2.63 m  
Length: 5.95 m  
Area: 15.66 m<sup>2</sup>  
Perimeter: 17.17 m

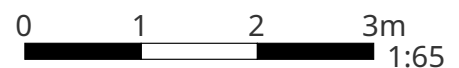
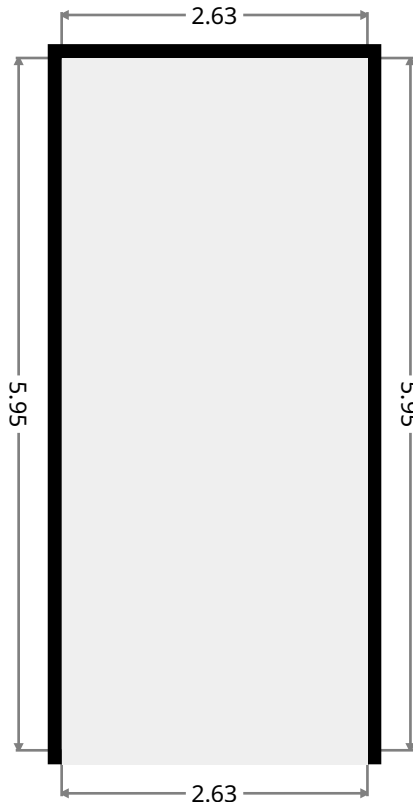
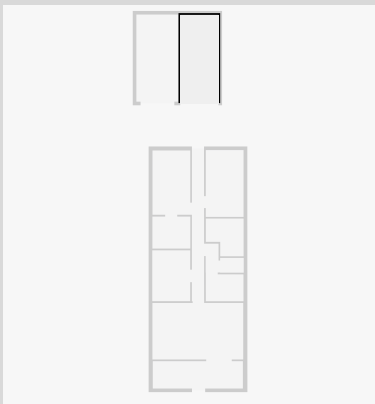

# Unit 2/182 Talford Street

## Garage

Width: 2.90 m  
Length: 6.00 m  
Area: 17.39 m<sup>2</sup>  
Perimeter: 17.79 m

