

# Unit 2/15 Brumm Street

## Ground Floor

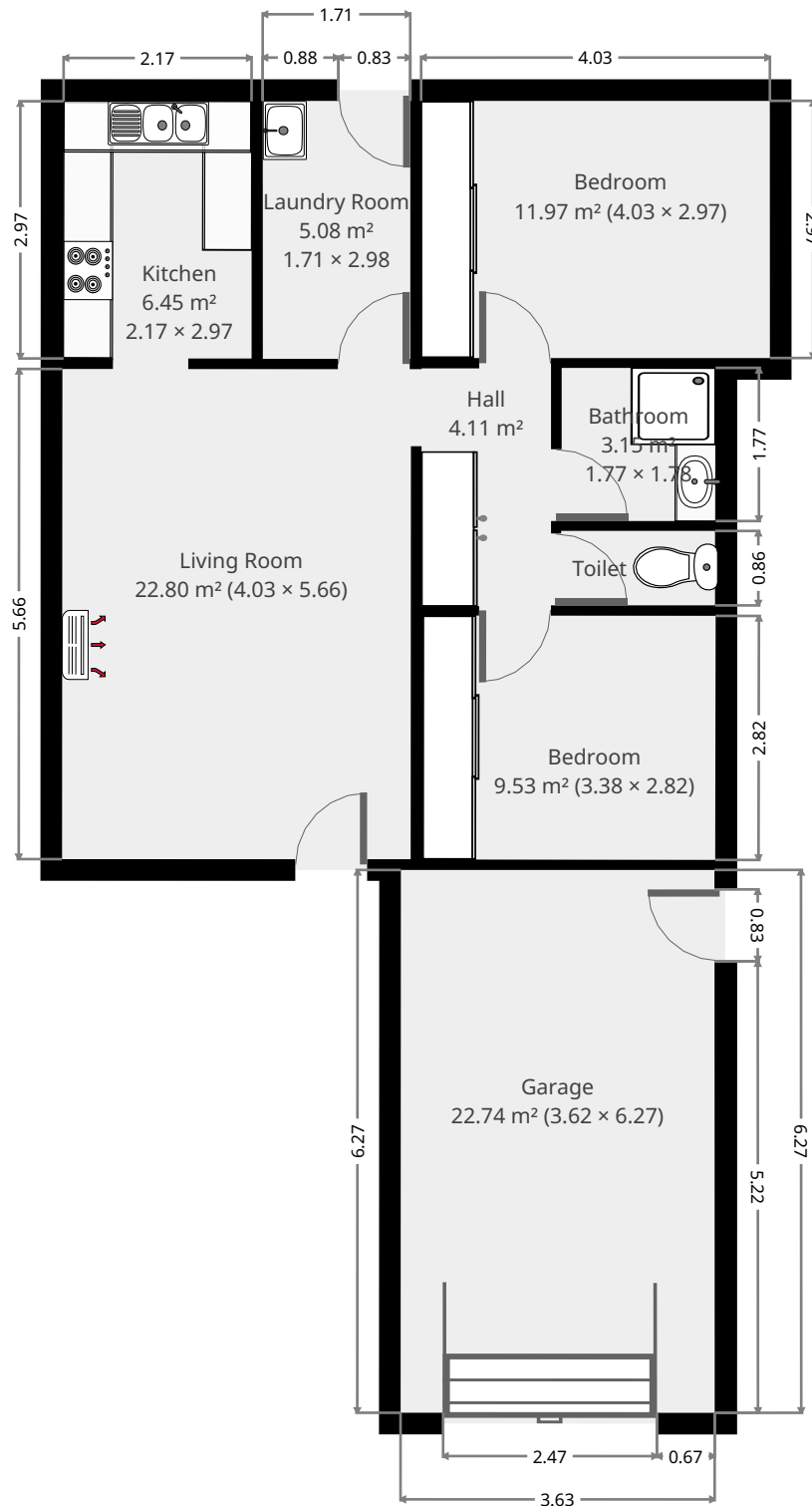

THIS FLOORPLAN IS PROVIDED WITHOUT WARRANTY OF ANY KIND. SENSOPIA DISCLAIMS ANY WARRANTY INCLUDING, WITHOUT LIMITATION, SATISFACTORY QUALITY OR ACCURACY OF DIMENSIONS.



# Unit 2/15 Brumm Street

## Living Room

Width: 4.03 m  
Length: 5.66 m  
Area: 22.80 m<sup>2</sup>  
Perimeter: 19.38 m

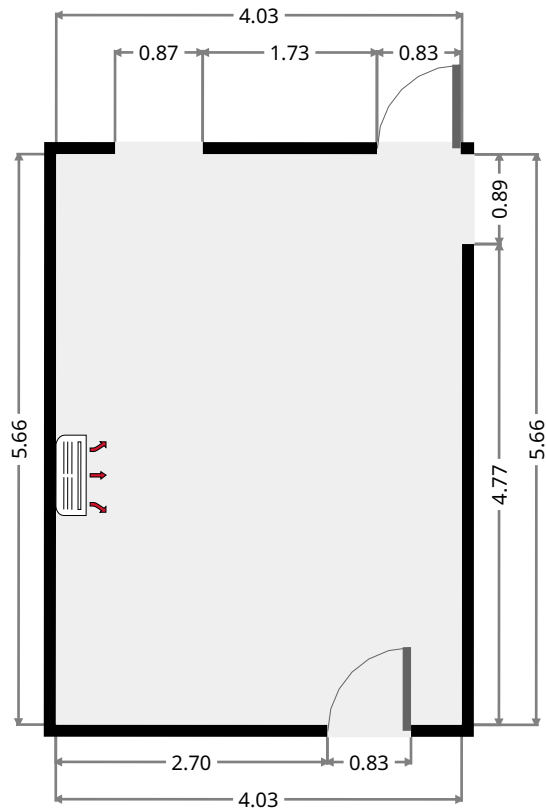
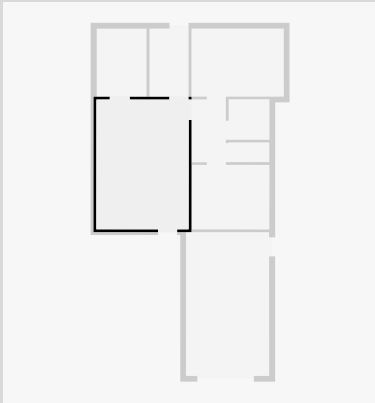

## Hall

Width: 1.50 m  
Length: 2.75 m  
Area: 4.11 m<sup>2</sup>  
Perimeter: 8.49 m

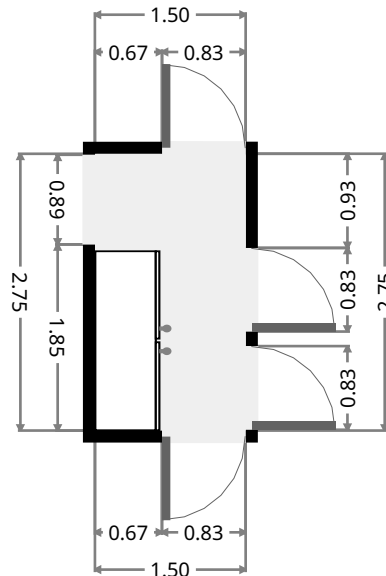
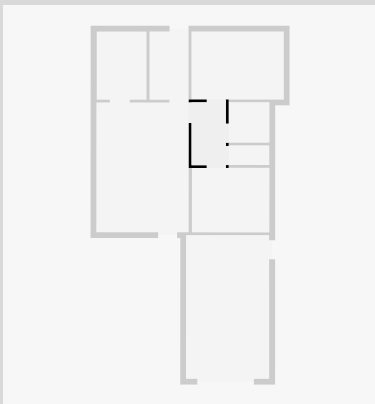

# Unit 2/15 Brumm Street

## Kitchen

Width: 2.17 m  
Length: 2.97 m  
Area: 6.45 m<sup>2</sup>  
Perimeter: 10.29 m

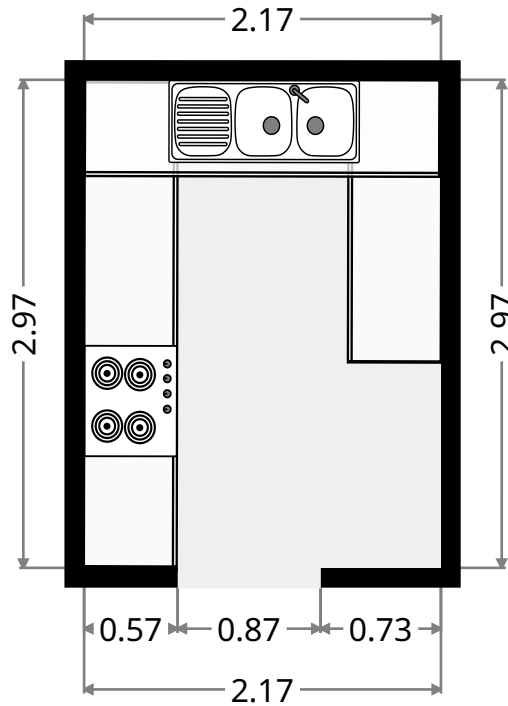
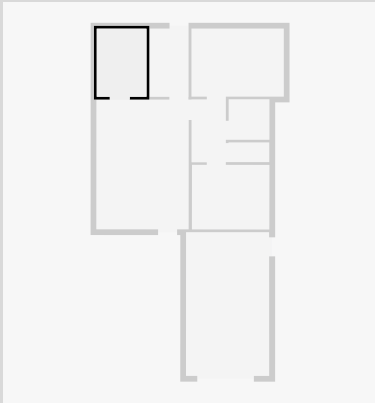

## Laundry Room

Width: 1.71 m  
Length: 2.98 m  
Area: 5.08 m<sup>2</sup>  
Perimeter: 9.37 m

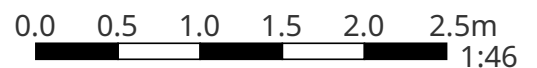
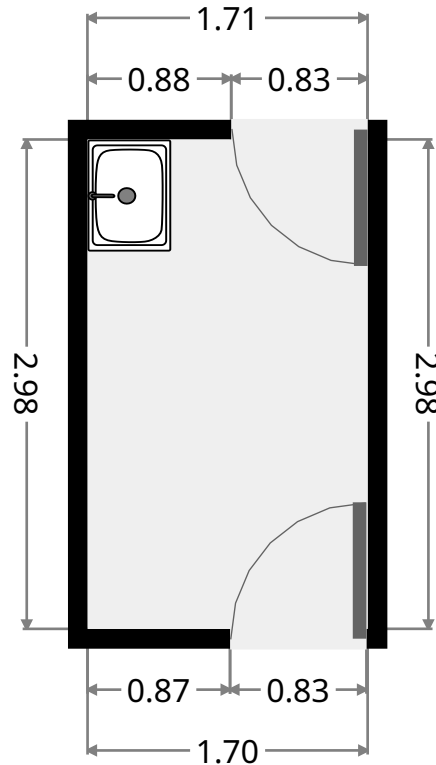
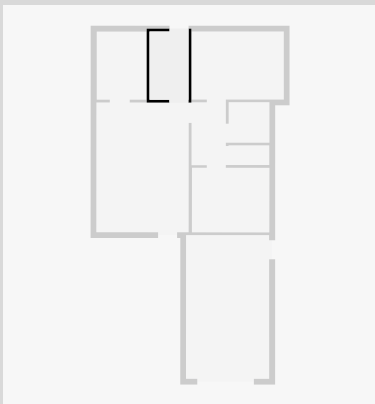

# Unit 2/15 Brumm Street

## Bedroom

Width: 2.97 m  
Length: 4.03 m  
Area: 11.97 m<sup>2</sup>  
Perimeter: 14.00 m

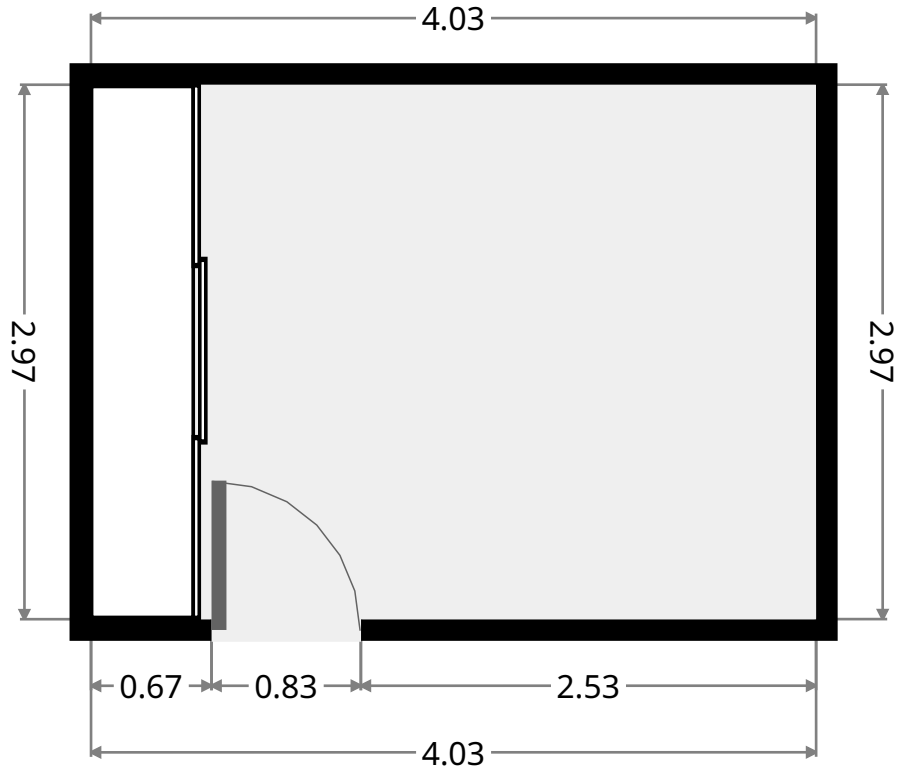
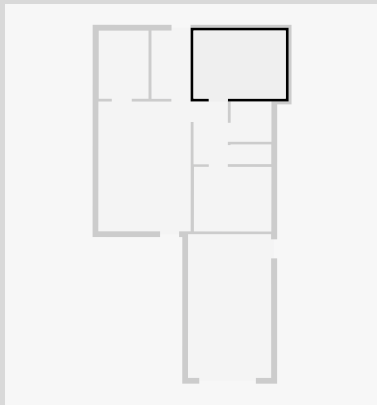

## Bathroom

Width: 1.77 m  
Length: 1.78 m  
Area: 3.15 m<sup>2</sup>  
Perimeter: 7.10 m

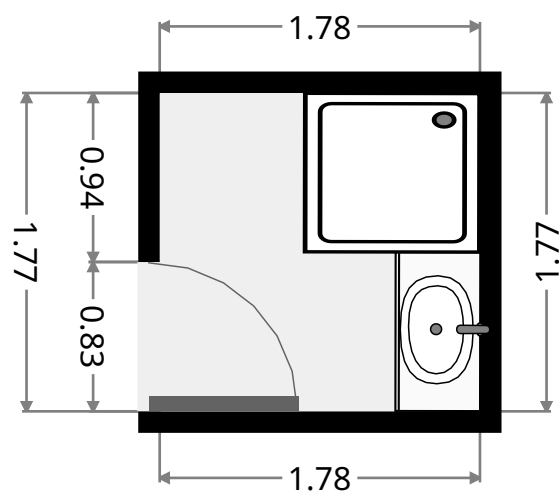
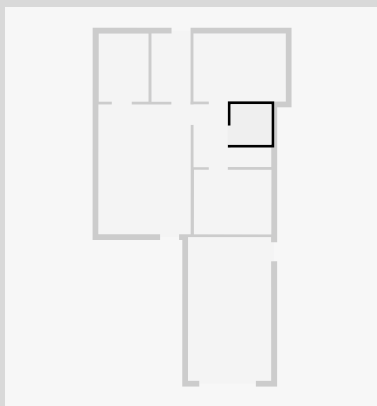

THIS FLOORPLAN IS PROVIDED WITHOUT WARRANTY OF ANY KIND. SENSOPIA DISCLAIMS ANY WARRANTY INCLUDING, WITHOUT LIMITATION, SATISFACTORY QUALITY OR ACCURACY OF DIMENSIONS.

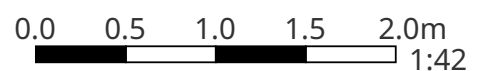

# Unit 2/15 Brumm Street

## Toilet / Half Bath

Width: 0.86 m  
Length: 1.78 m  
Area: 1.53 m<sup>2</sup>  
Perimeter: 5.28 m

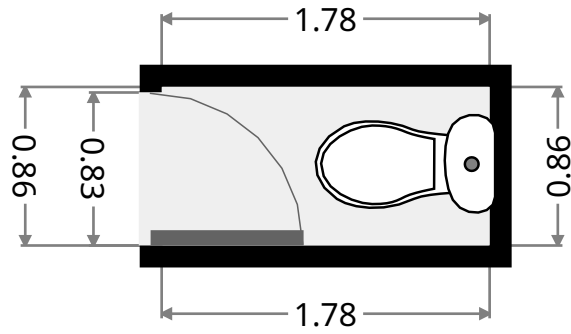
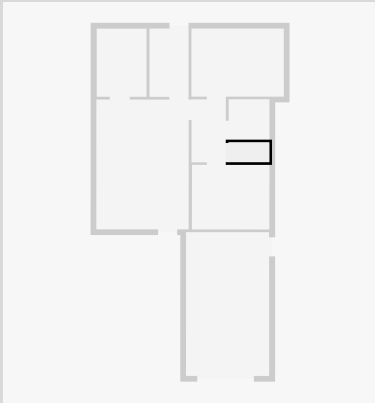

## Bedroom

Width: 2.82 m  
Length: 3.38 m  
Area: 9.53 m<sup>2</sup>  
Perimeter: 12.40 m

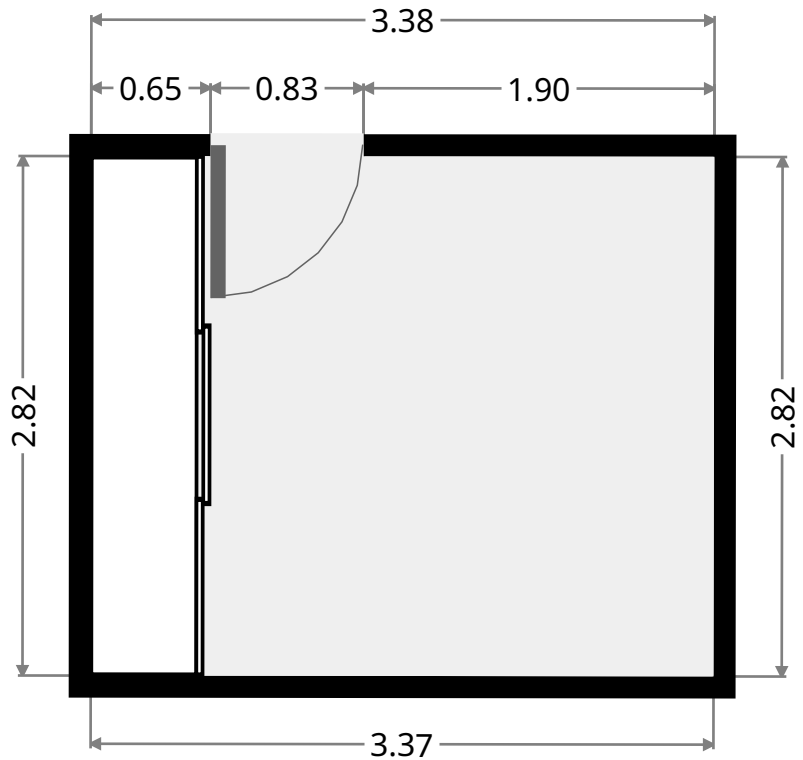
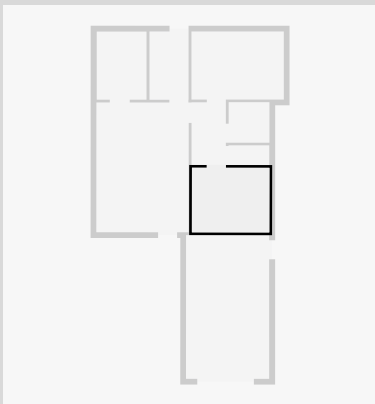

# Unit 2/15 Brumm Street

## Garage

Width: 3.62 m  
Length: 6.27 m  
Area: 22.74 m<sup>2</sup>  
Perimeter: 19.79 m

