

Ground Floor

Ray White Rockhampton
 Rockhampton.pm2@raywhite.com
 (07)4923 0000
 2016-10-31

71 m²
 1 Floor
 2 Bedrooms
 1 Bathroom

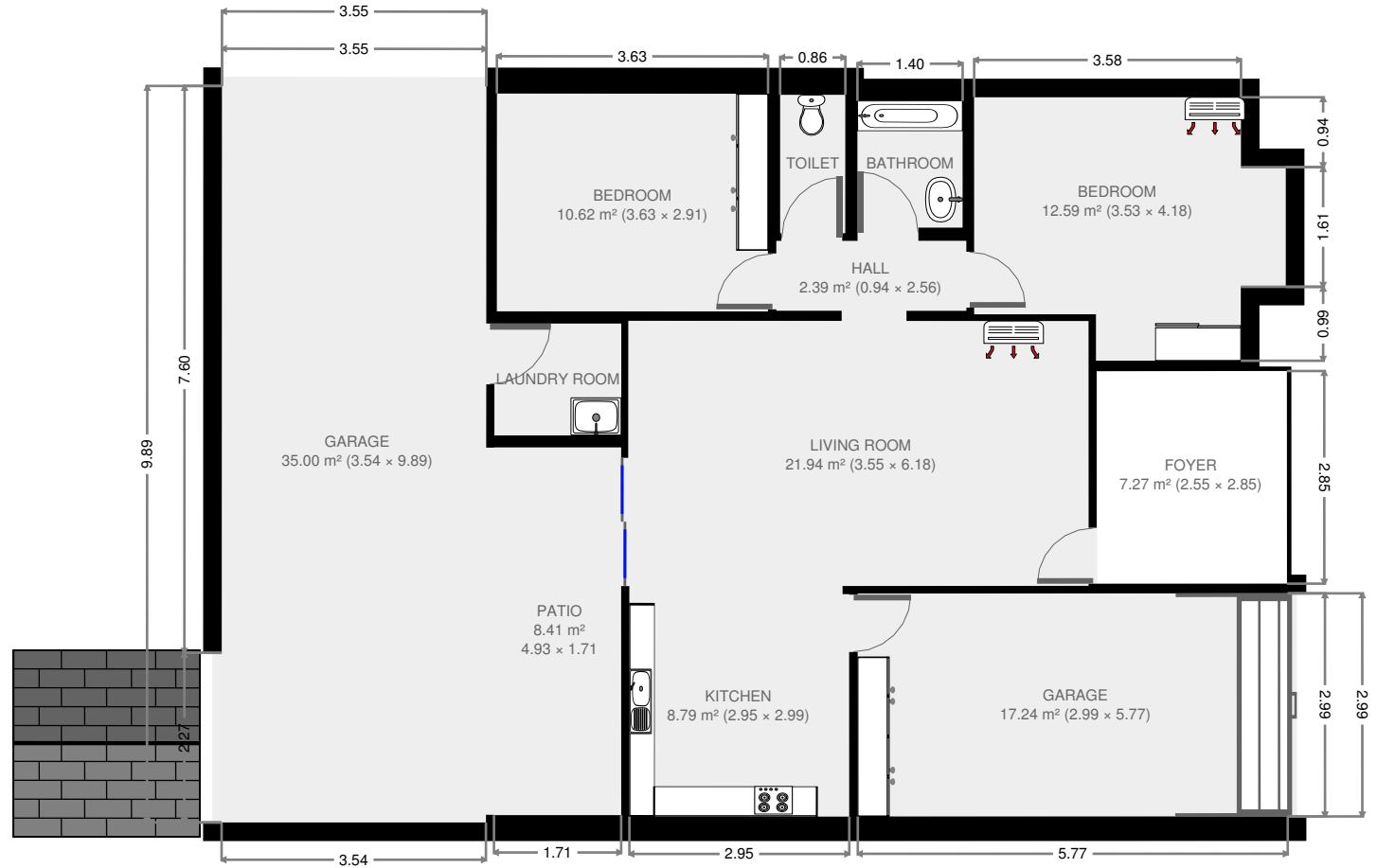

THIS FLOORPLAN IS PROVIDED WITHOUT WARRANTY OF ANY KIND. RAY WHITE ROCKHAMPTON DISCLAIMS ANY WARRANTY INCLUDING, WITHOUT LIMITATION, SATISFACTORY QUALITY OR ACCURACY OF DIMENSIONS. ALL CARE IS TAKEN TO ENSURE ACCURACY BUT MEASUREMENTS, POSITIONING AND PLACEMENTS CANNOT BE GUARANTEED.



Living Room

Width: 3.55 m
 Length: 6.18 m
 Area: 21.94 m²
 Perimeter: 19.45 m

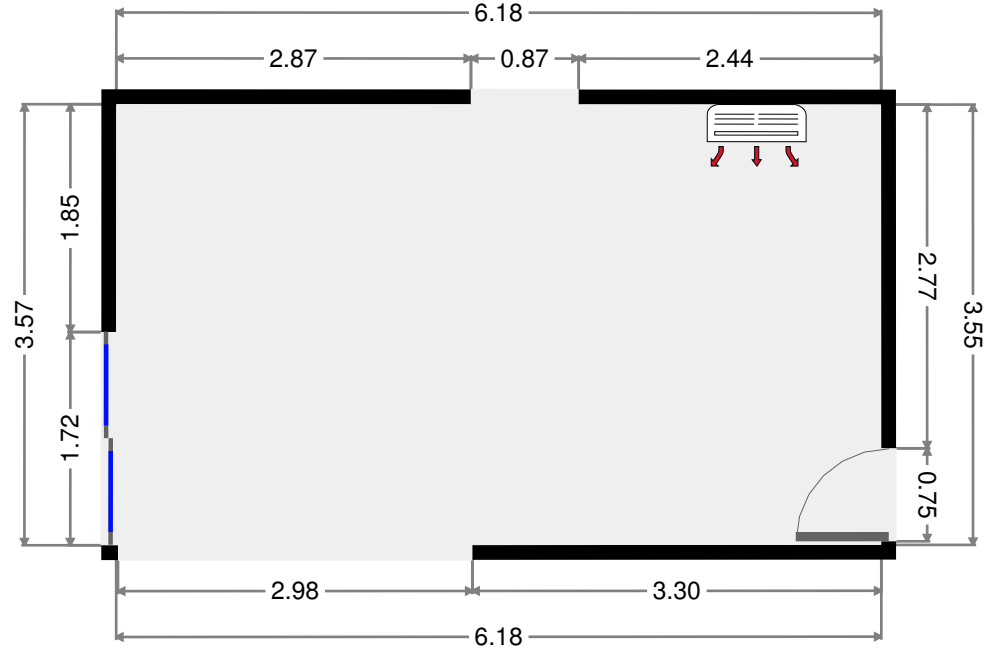
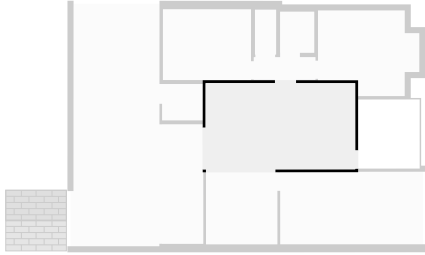

Kitchen

Width: 2.95 m
 Length: 2.99 m
 Area: 8.79 m²
 Perimeter: 11.86 m

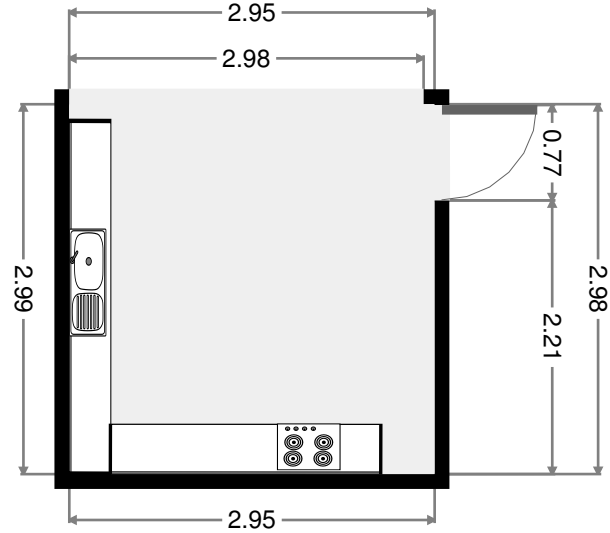
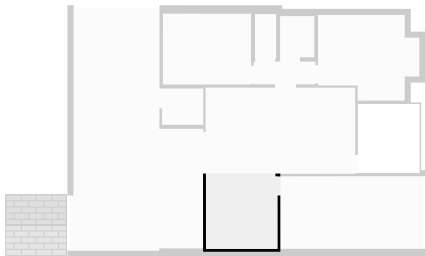

THIS FLOORPLAN IS PROVIDED WITHOUT WARRANTY OF ANY KIND. RAY WHITE ROCKHAMPTON DISCLAIMS ANY WARRANTY INCLUDING, WITHOUT LIMITATION, SATISFACTORY QUALITY OR ACCURACY OF DIMENSIONS. ALL CARE IS TAKEN TO ENSURE ACCURACY BUT MEASUREMENTS, POSITIONING AND PLACEMENTS CANNOT BE GUARANTEED.



Garage

Width: 2.99 m
 Length: 5.77 m
 Area: 17.24 m²
 Perimeter: 17.51 m

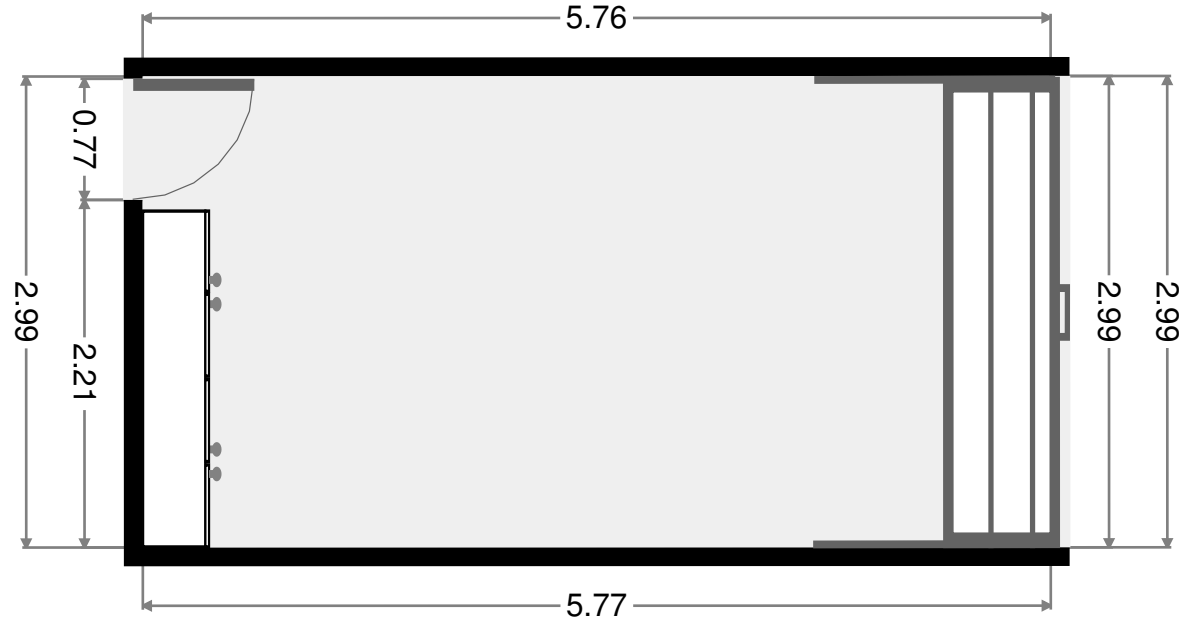
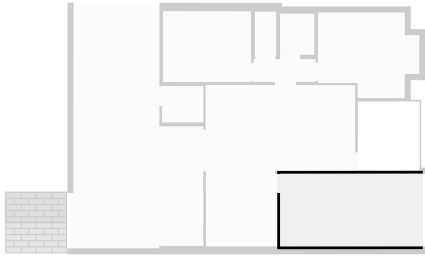

Hall

Width: 0.94 m
 Length: 2.56 m
 Area: 2.39 m²
 Perimeter: 6.97 m

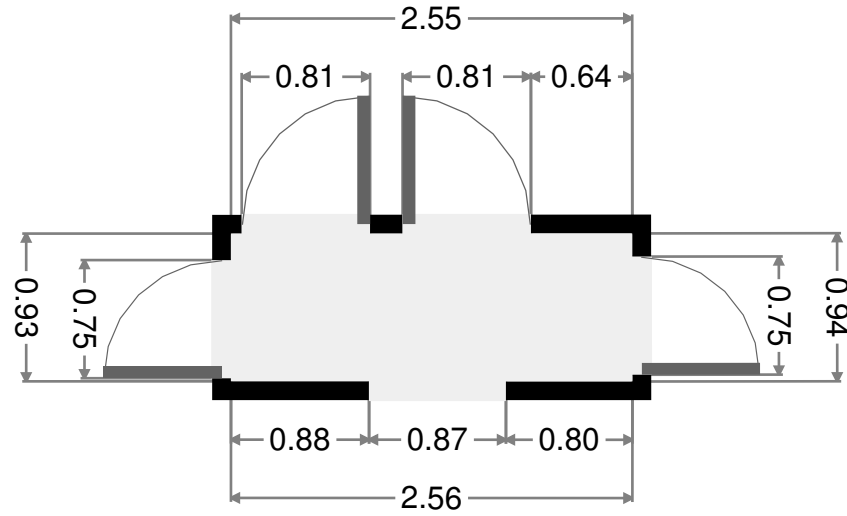
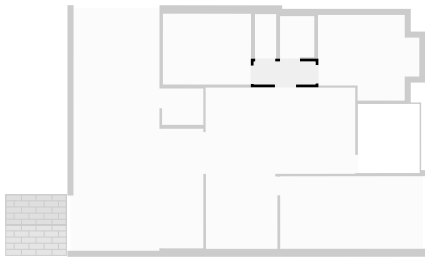

THIS FLOORPLAN IS PROVIDED WITHOUT WARRANTY OF ANY KIND. RAY WHITE ROCKHAMPTON DISCLAIMS ANY WARRANTY INCLUDING, WITHOUT LIMITATION, SATISFACTORY QUALITY OR ACCURACY OF DIMENSIONS. ALL CARE IS TAKEN TO ENSURE ACCURACY BUT MEASUREMENTS, POSITIONING AND PLACEMENTS CANNOT BE GUARANTEED.



Bedroom

Width: 3.53 m
 Length: 4.18 m
 Area: 12.59 m²
 Perimeter: 15.42 m
 Ceiling Height: 2.17 m

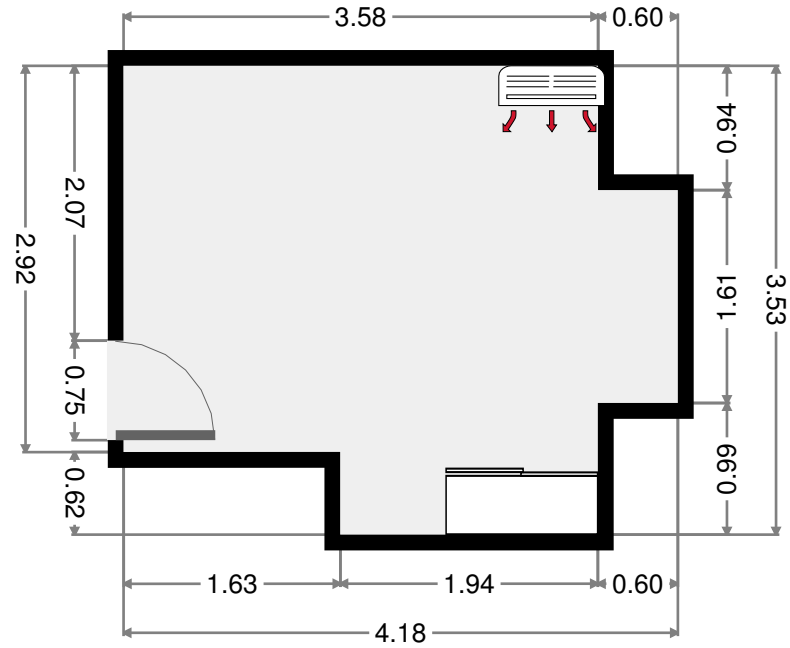
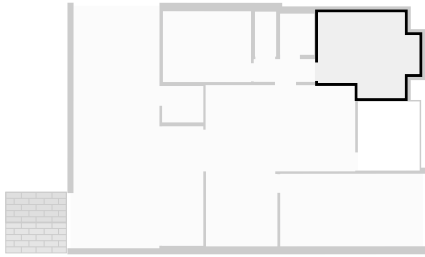

Bathroom

Width: 1.40 m
 Length: 1.70 m
 Area: 2.39 m²
 Perimeter: 6.22 m

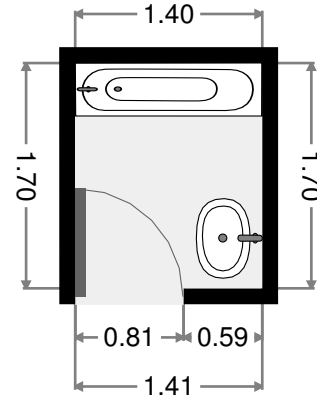
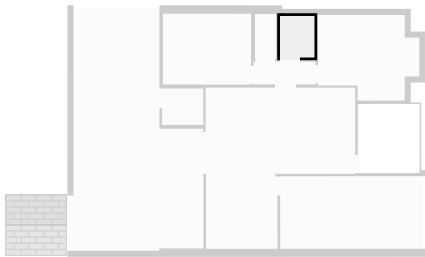

THIS FLOORPLAN IS PROVIDED WITHOUT WARRANTY OF ANY KIND. RAY WHITE ROCKHAMPTON DISCLAIMS ANY WARRANTY INCLUDING, WITHOUT LIMITATION, SATISFACTORY QUALITY OR ACCURACY OF DIMENSIONS. ALL CARE IS TAKEN TO ENSURE ACCURACY BUT MEASUREMENTS, POSITIONING AND PLACEMENTS CANNOT BE GUARANTEED.



Toilet

Width: 0.87 m
 Length: 1.86 m
 Area: 1.62 m²
 Perimeter: 5.46 m

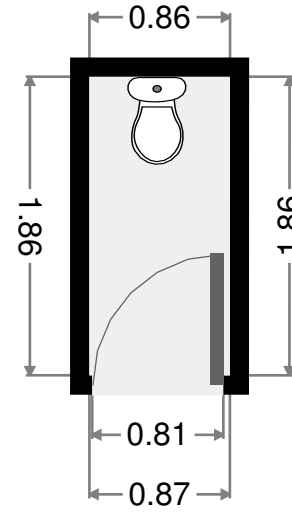
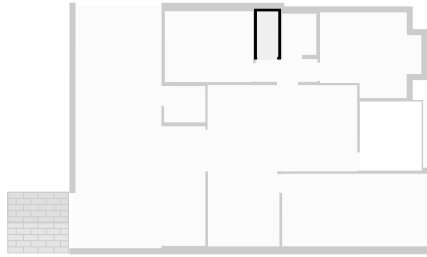

Bedroom

Width: 2.91 m
 Length: 3.63 m
 Area: 10.62 m²
 Perimeter: 13.11 m

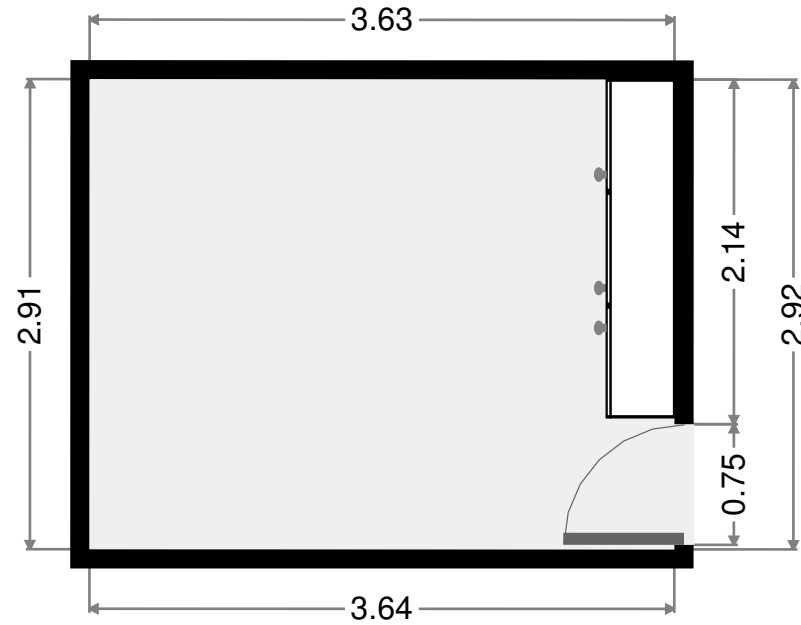
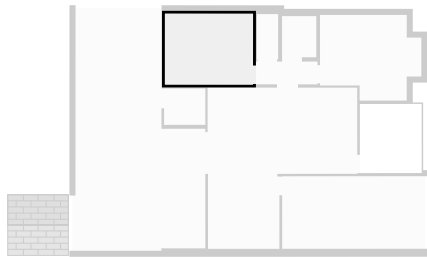

THIS FLOORPLAN IS PROVIDED WITHOUT WARRANTY OF ANY KIND. RAY WHITE ROCKHAMPTON DISCLAIMS ANY WARRANTY INCLUDING, WITHOUT LIMITATION, SATISFACTORY QUALITY OR ACCURACY OF DIMENSIONS. ALL CARE IS TAKEN TO ENSURE ACCURACY BUT MEASUREMENTS, POSITIONING AND PLACEMENTS CANNOT BE GUARANTEED.



Patio

Width: 1.71 m
 Length: 4.93 m
 Area: 8.41 m²
 Perimeter: 13.27 m

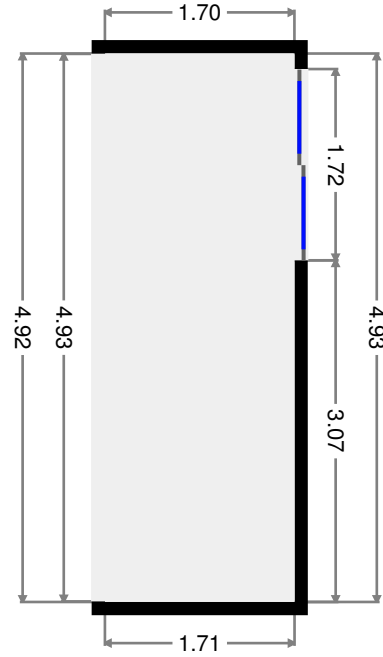
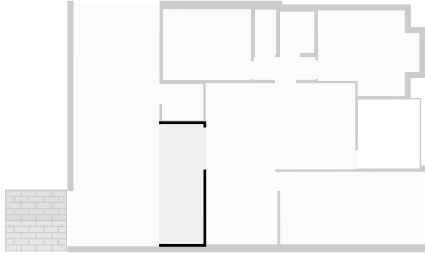

Laundry Room

Width: 1.50 m
 Length: 1.71 m
 Area: 2.55 m²
 Perimeter: 6.40 m

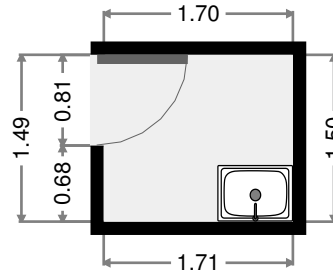
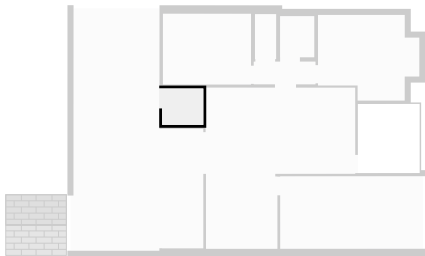

THIS FLOORPLAN IS PROVIDED WITHOUT WARRANTY OF ANY KIND. RAY WHITE ROCKHAMPTON DISCLAIMS ANY WARRANTY INCLUDING, WITHOUT LIMITATION, SATISFACTORY QUALITY OR ACCURACY OF DIMENSIONS. ALL CARE IS TAKEN TO ENSURE ACCURACY BUT MEASUREMENTS, POSITIONING AND PLACEMENTS CANNOT BE GUARANTEED.



Garage

Width: 3.54 m
 Length: 9.89 m
 Area: 35.00 m²
 Perimeter: 26.84 m

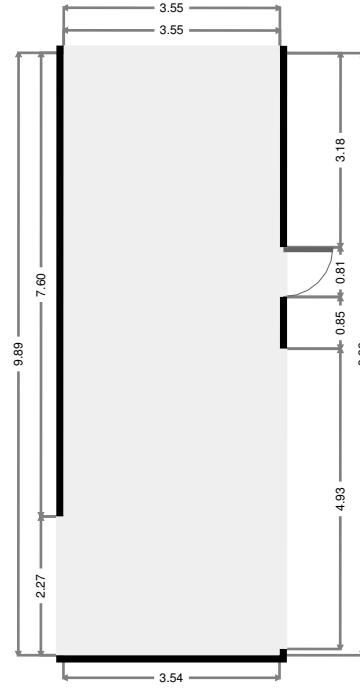

Foyer

Width: 2.55 m
 Length: 2.85 m
 Area: 7.27 m²
 Perimeter: 10.80 m
 Ceiling Height: 2.17 m

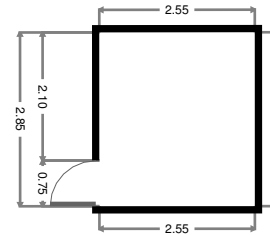
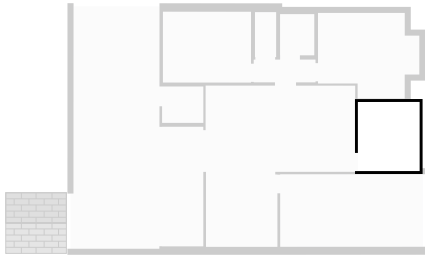

THIS FLOORPLAN IS PROVIDED WITHOUT WARRANTY OF ANY KIND. RAY WHITE ROCKHAMPTON DISCLAIMS ANY WARRANTY INCLUDING, WITHOUT LIMITATION, SATISFACTORY QUALITY OR ACCURACY OF DIMENSIONS. ALL CARE IS TAKEN TO ENSURE ACCURACY BUT MEASUREMENTS, POSITIONING AND PLACEMENTS CANNOT BE GUARANTEED.

