

Unit 1-2 Kawana Close, Kawana

Ground Floor

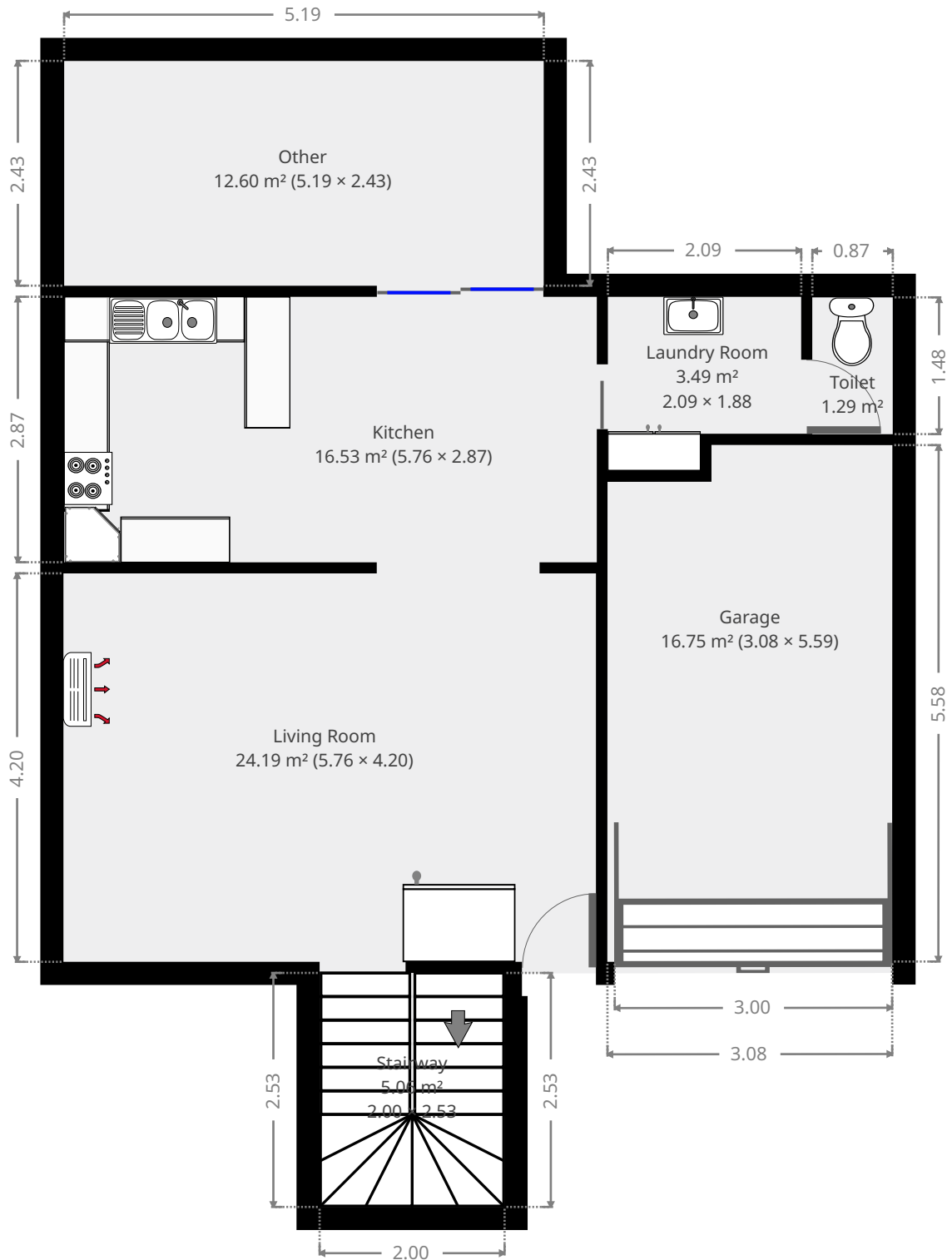

THIS FLOORPLAN IS PROVIDED WITHOUT WARRANTY OF ANY KIND. SENSOPIA DISCLAIMS ANY WARRANTY INCLUDING, WITHOUT LIMITATION, SATISFACTORY QUALITY OR ACCURACY OF DIMENSIONS.



Unit 1-2 Kawana Close, Kawana

Living Room

Width: 4.20 m
 Length: 5.76 m
 Area: 24.19 m²
 Perimeter: 19.92 m

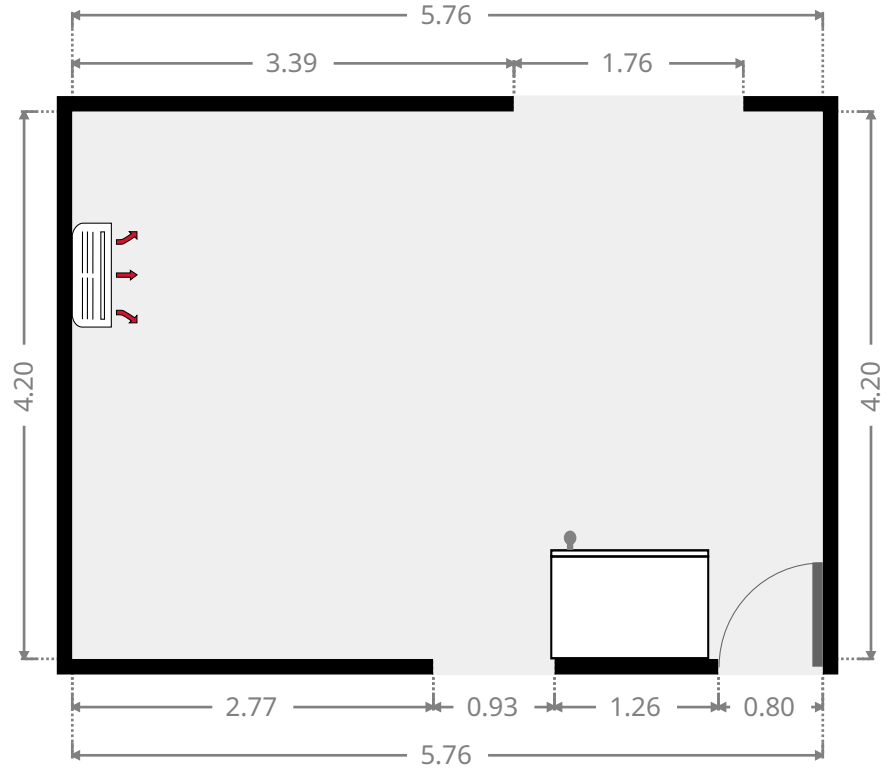
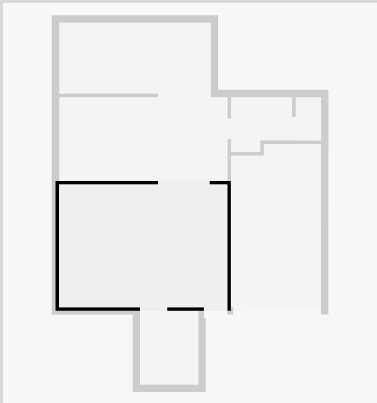

Kitchen

Width: 2.87 m
 Length: 5.76 m
 Area: 16.53 m²
 Perimeter: 17.26 m

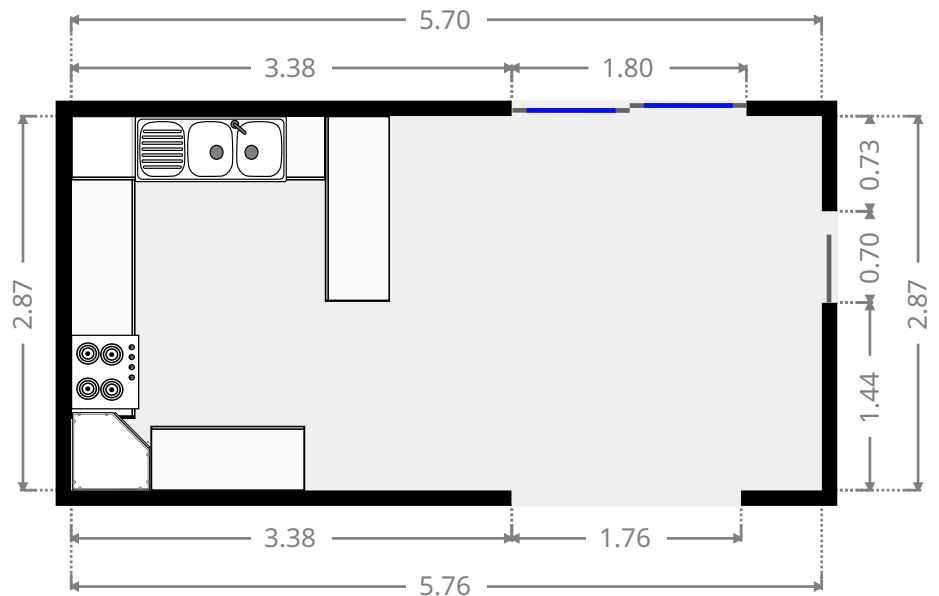
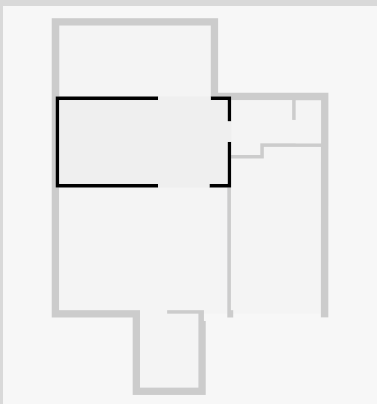

THIS FLOORPLAN IS PROVIDED WITHOUT WARRANTY OF ANY KIND. SENSOPIA DISCLAIMS ANY WARRANTY INCLUDING, WITHOUT LIMITATION, SATISFACTORY QUALITY OR ACCURACY OF DIMENSIONS.

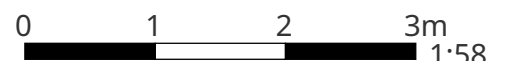

Unit 1-2 Kawana Close, Kawana

Laundry Room

Width: 1.88 m
Length: 2.09 m
Area: 3.49 m²
Perimeter: 7.94 m

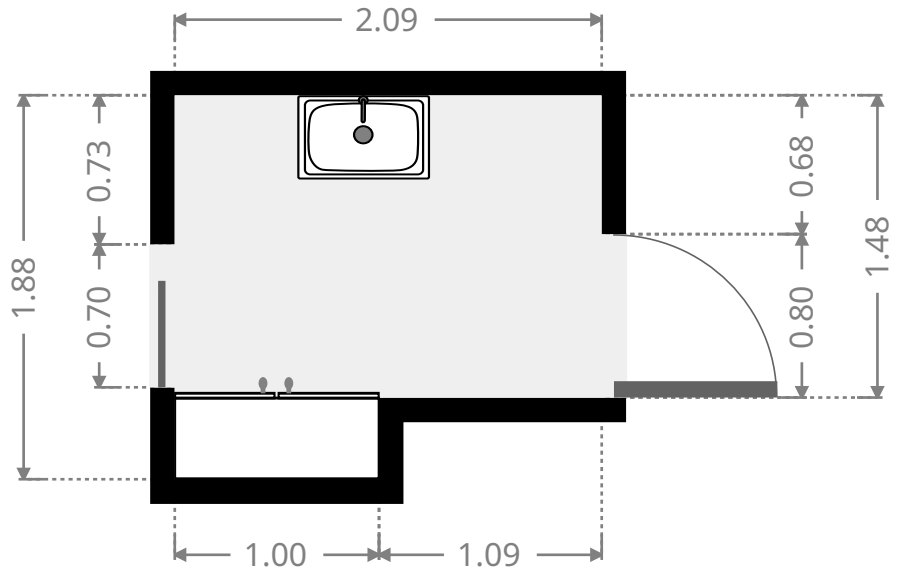
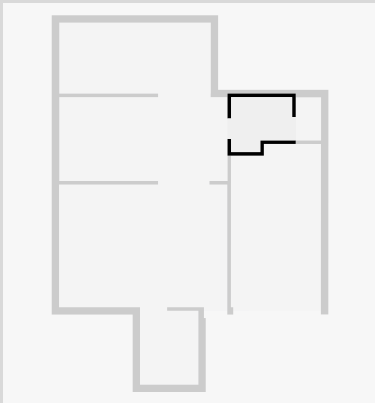

Toilet / Half Bath

Width: 0.87 m
Length: 1.48 m
Area: 1.29 m²
Perimeter: 4.70 m

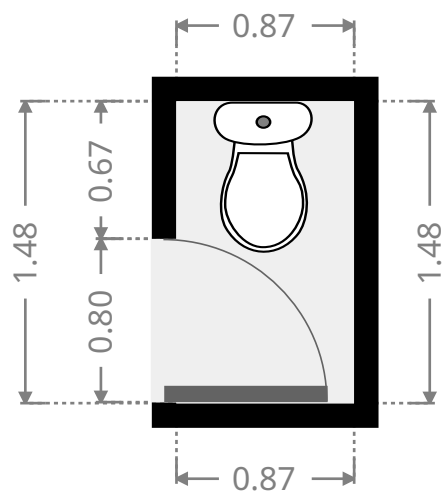
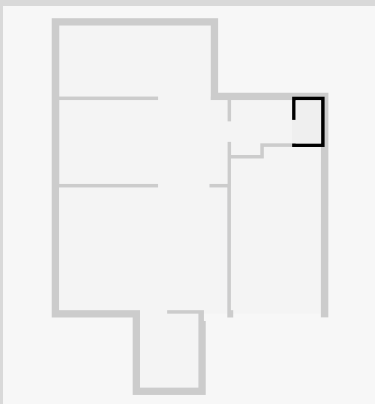

THIS FLOORPLAN IS PROVIDED WITHOUT WARRANTY OF ANY KIND. SENSOPIA DISCLAIMS ANY WARRANTY INCLUDING, WITHOUT LIMITATION, SATISFACTORY QUALITY OR ACCURACY OF DIMENSIONS.

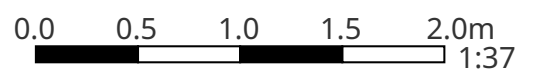

Unit 1-2 Kawana Close, Kawana

Garage

Width: 3.08 m
 Length: 5.59 m
 Area: 16.75 m²
 Perimeter: 17.33 m

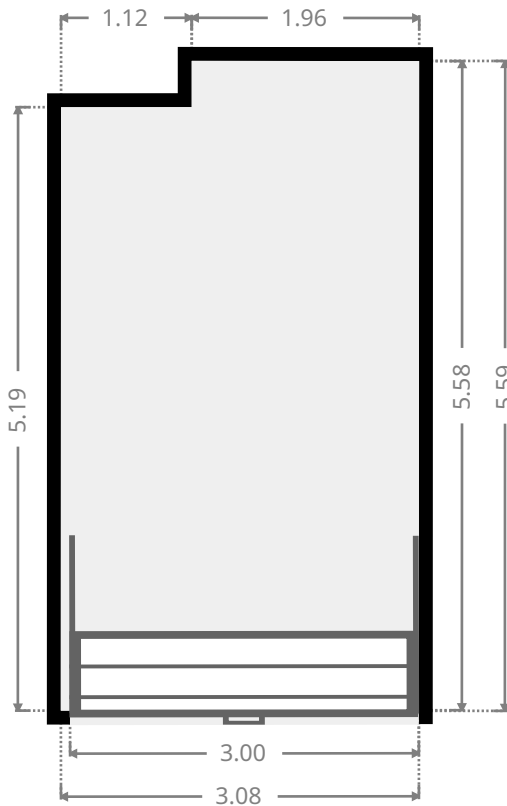
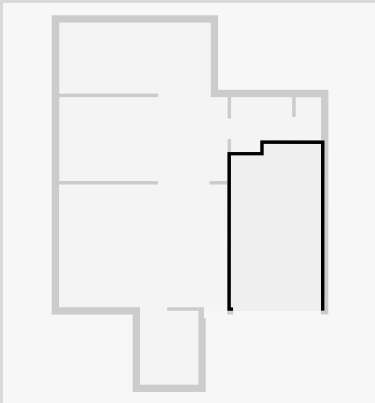

Stairway

Width: 2.00 m
 Length: 2.53 m
 Area: 5.06 m²
 Perimeter: 9.06 m

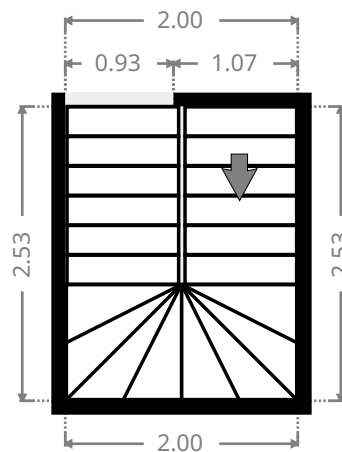
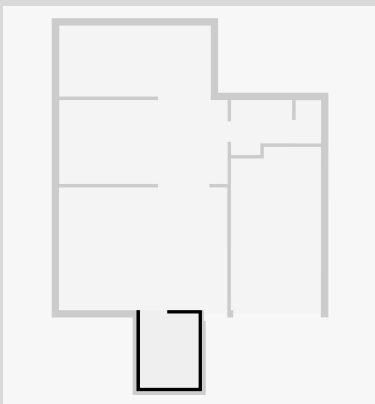

THIS FLOORPLAN IS PROVIDED WITHOUT WARRANTY OF ANY KIND. SENSOPIA DISCLAIMS ANY WARRANTY INCLUDING, WITHOUT LIMITATION, SATISFACTORY QUALITY OR ACCURACY OF DIMENSIONS.

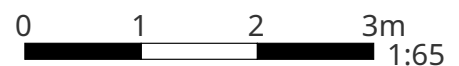

Unit 1-2 Kawana Close, Kawana

Other

Width: 2.43 m
Length: 5.19 m
Area: 12.60 m²
Perimeter: 15.23 m

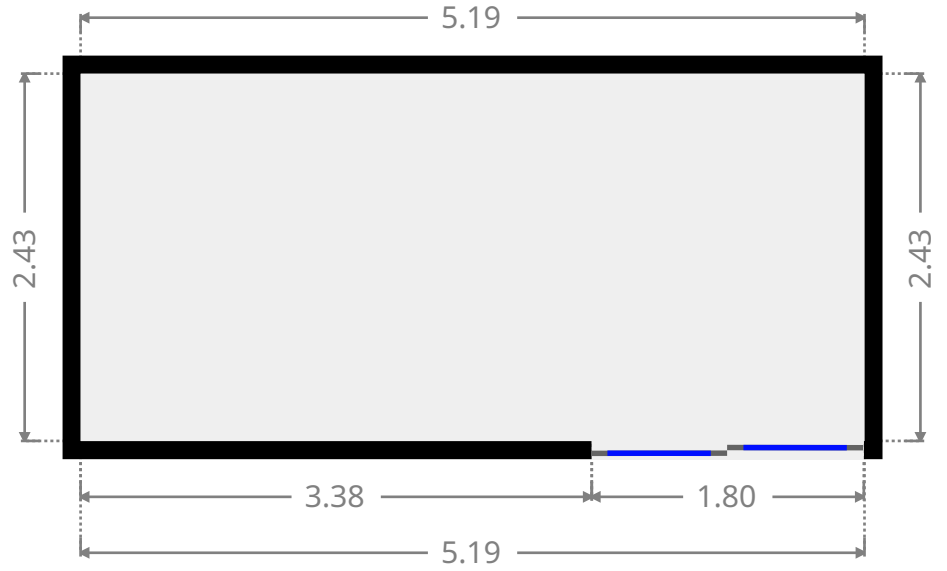
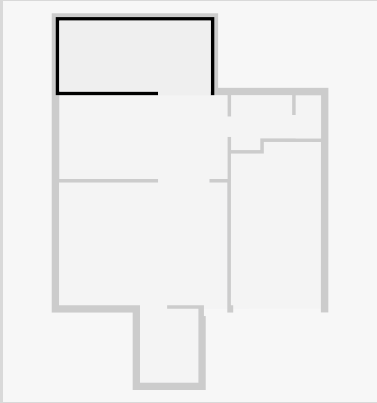

Unit 1-2 Kawana Close, Kawana

1st Floor

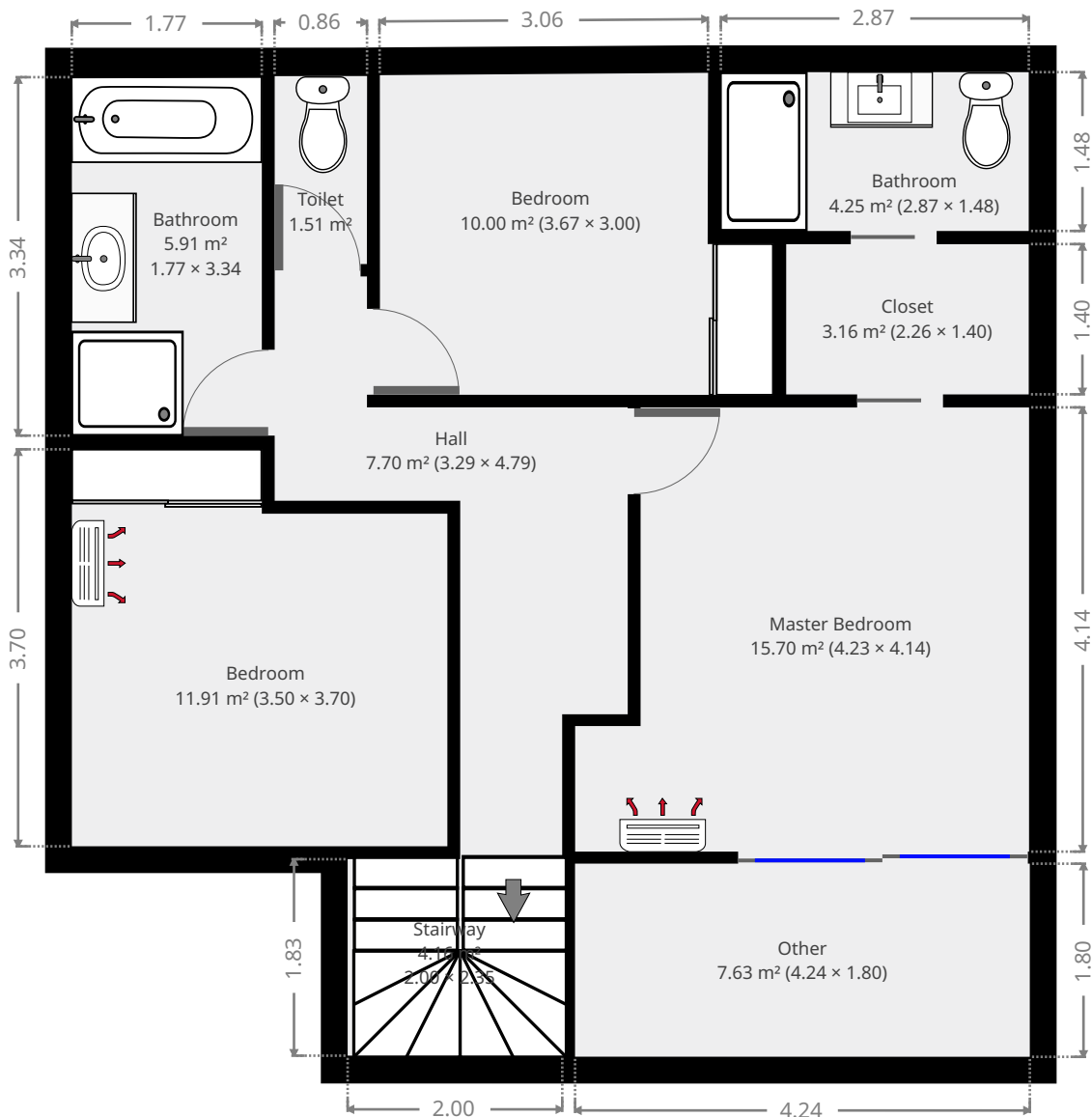

THIS FLOORPLAN IS PROVIDED WITHOUT WARRANTY OF ANY KIND. SENSOPIA DISCLAIMS ANY WARRANTY INCLUDING, WITHOUT LIMITATION, SATISFACTORY QUALITY OR ACCURACY OF DIMENSIONS.



Unit 1-2 Kawana Close, Kawana

Hall

Width: 3.29 m
 Length: 4.79 m
 Area: 7.70 m²
 Perimeter: 16.17 m

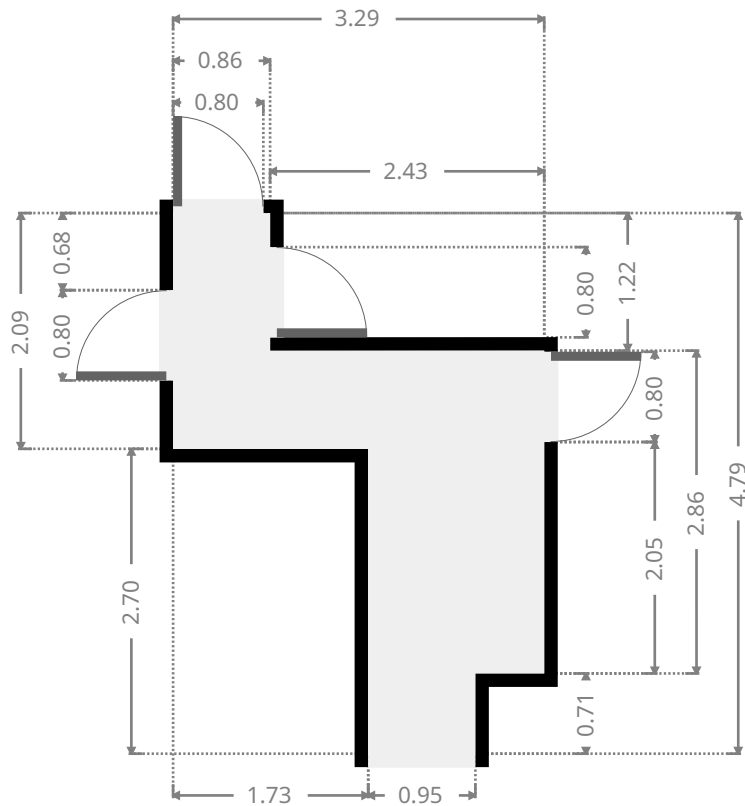
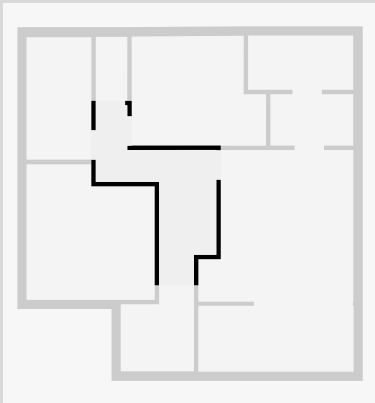

Master Bedroom

Width: 4.14 m
 Length: 4.23 m
 Area: 15.70 m²
 Perimeter: 16.74 m

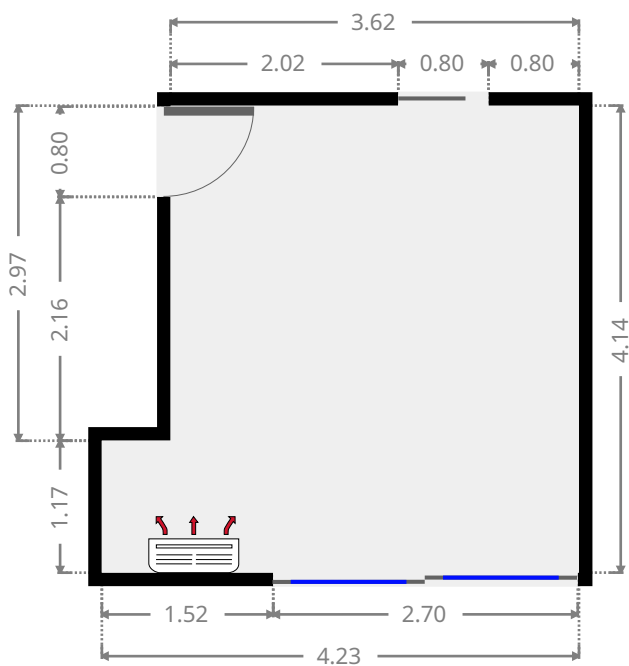
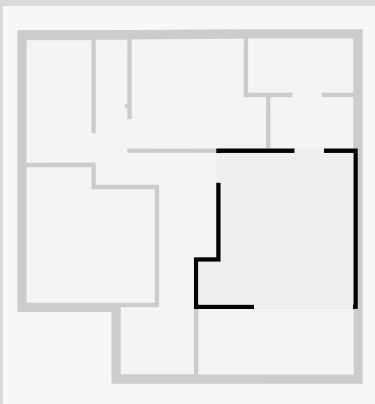

THIS FLOORPLAN IS PROVIDED WITHOUT WARRANTY OF ANY KIND. SENSOPIA DISCLAIMS ANY WARRANTY INCLUDING, WITHOUT LIMITATION, SATISFACTORY QUALITY OR ACCURACY OF DIMENSIONS.

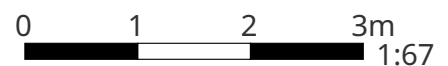

Unit 1-2 Kawana Close, Kawana

Closet

Width: 1.40 m
 Length: 2.26 m
 Area: 3.16 m²
 Perimeter: 7.32 m

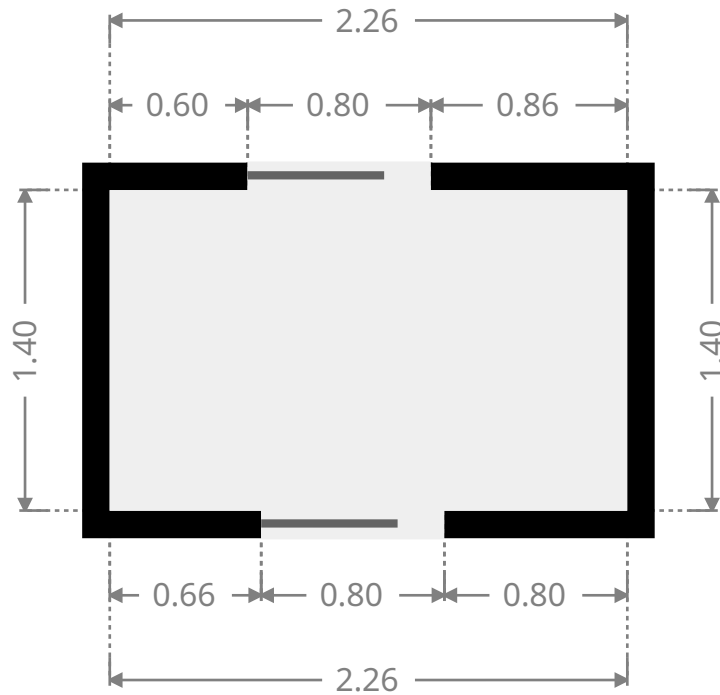
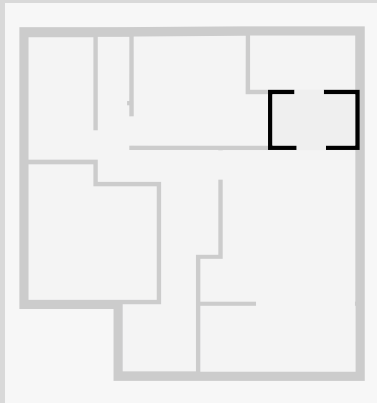

Bathroom

Width: 1.48 m
 Length: 2.87 m
 Area: 4.25 m²
 Perimeter: 8.70 m

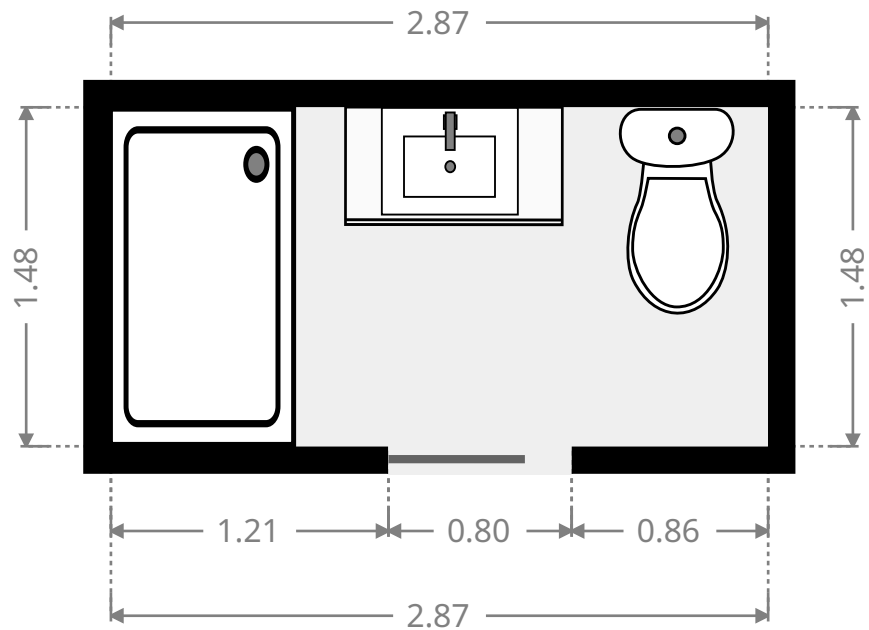
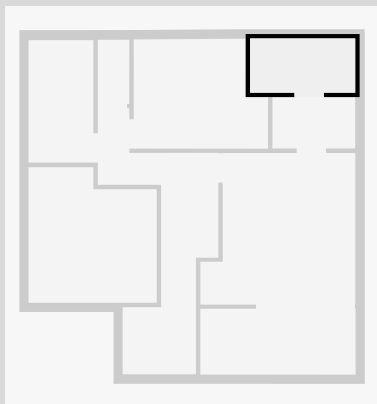

THIS FLOORPLAN IS PROVIDED WITHOUT WARRANTY OF ANY KIND. SENSOPIA DISCLAIMS ANY WARRANTY INCLUDING, WITHOUT LIMITATION, SATISFACTORY QUALITY OR ACCURACY OF DIMENSIONS.

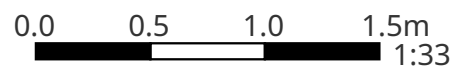

Unit 1-2 Kawana Close, Kawana

Other

Width: 1.80 m
 Length: 4.24 m
 Area: 7.63 m²
 Perimeter: 12.08 m

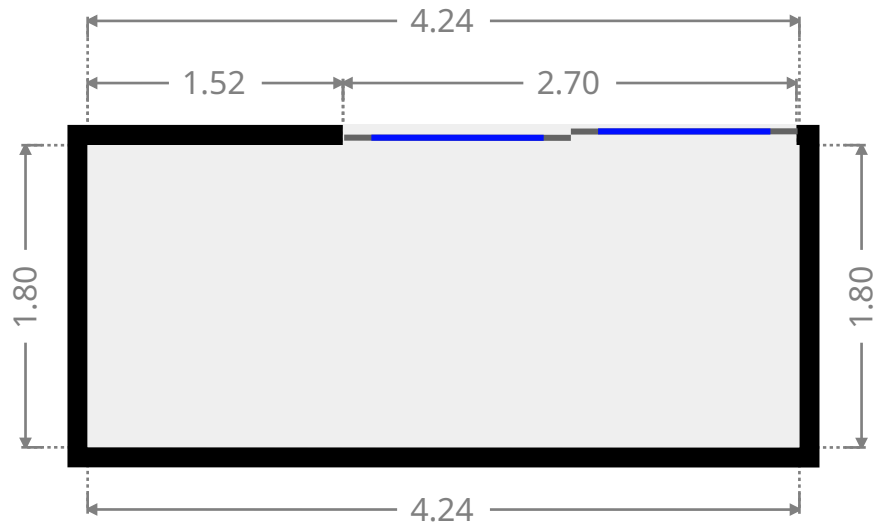
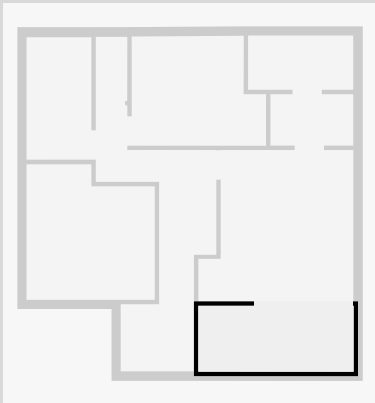

Bedroom

Width: 3.50 m
 Length: 3.70 m
 Area: 11.91 m²
 Perimeter: 14.40 m

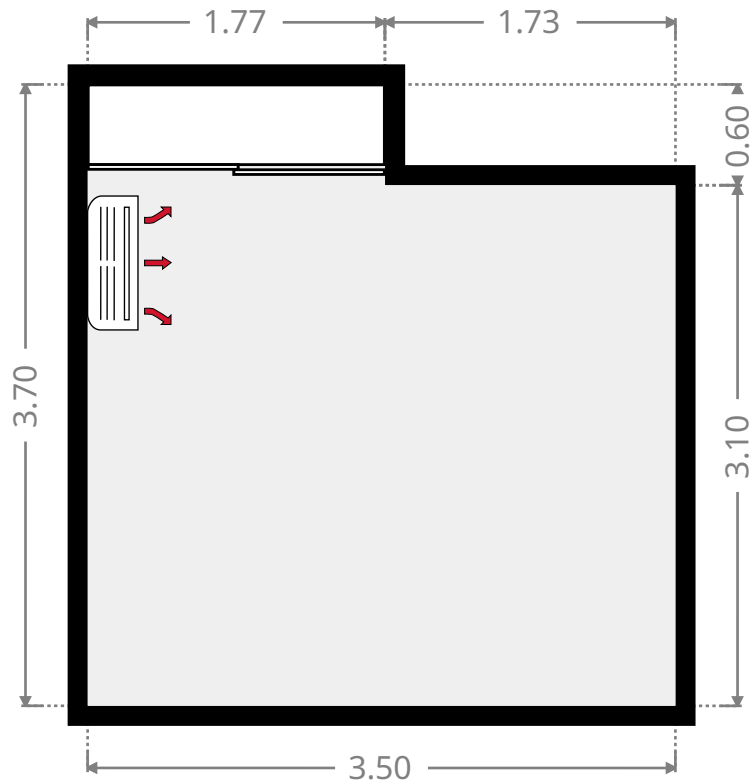
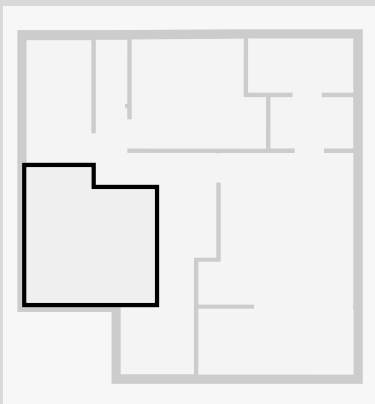

THIS FLOORPLAN IS PROVIDED WITHOUT WARRANTY OF ANY KIND. SENSOPIA DISCLAIMS ANY WARRANTY INCLUDING, WITHOUT LIMITATION, SATISFACTORY QUALITY OR ACCURACY OF DIMENSIONS.

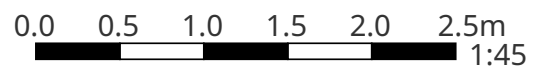

Unit 1-2 Kawana Close, Kawana

Bathroom

Width: 1.77 m
 Length: 3.34 m
 Area: 5.91 m²
 Perimeter: 10.22 m

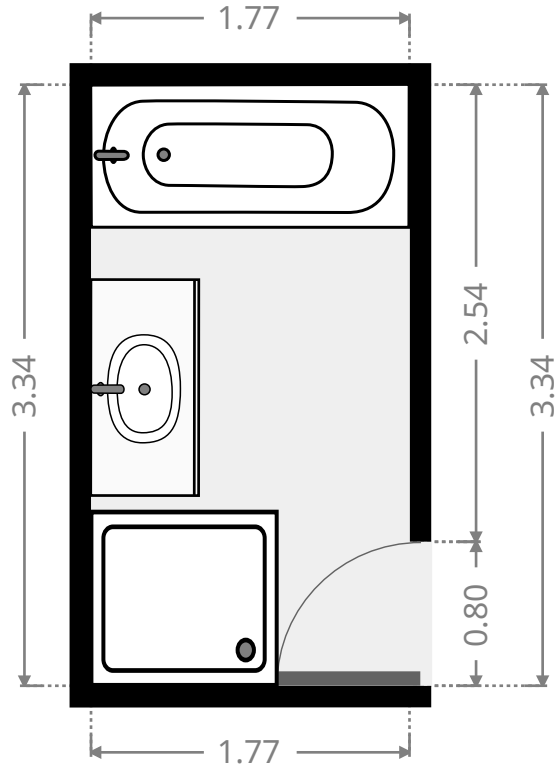
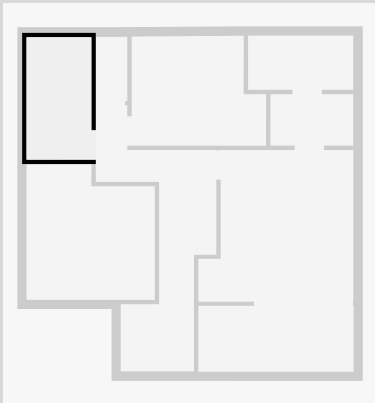

Toilet / Half Bath

Width: 0.86 m
 Length: 1.75 m
 Area: 1.51 m²
 Perimeter: 5.22 m

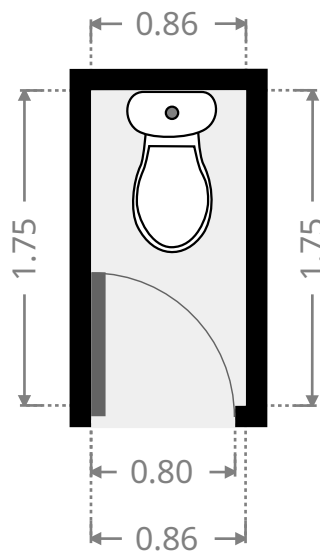
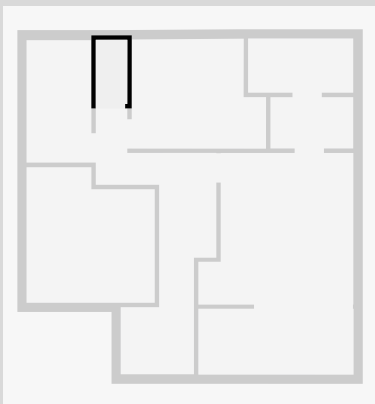

THIS FLOORPLAN IS PROVIDED WITHOUT WARRANTY OF ANY KIND. SENSOPIA DISCLAIMS ANY WARRANTY INCLUDING, WITHOUT LIMITATION, SATISFACTORY QUALITY OR ACCURACY OF DIMENSIONS.

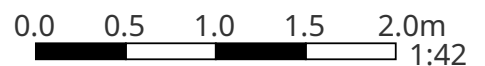

Unit 1-2 Kawana Close, Kawana

Bedroom

Width: 3.00 m
 Length: 3.67 m
 Area: 10.00 m²
 Perimeter: 13.32 m

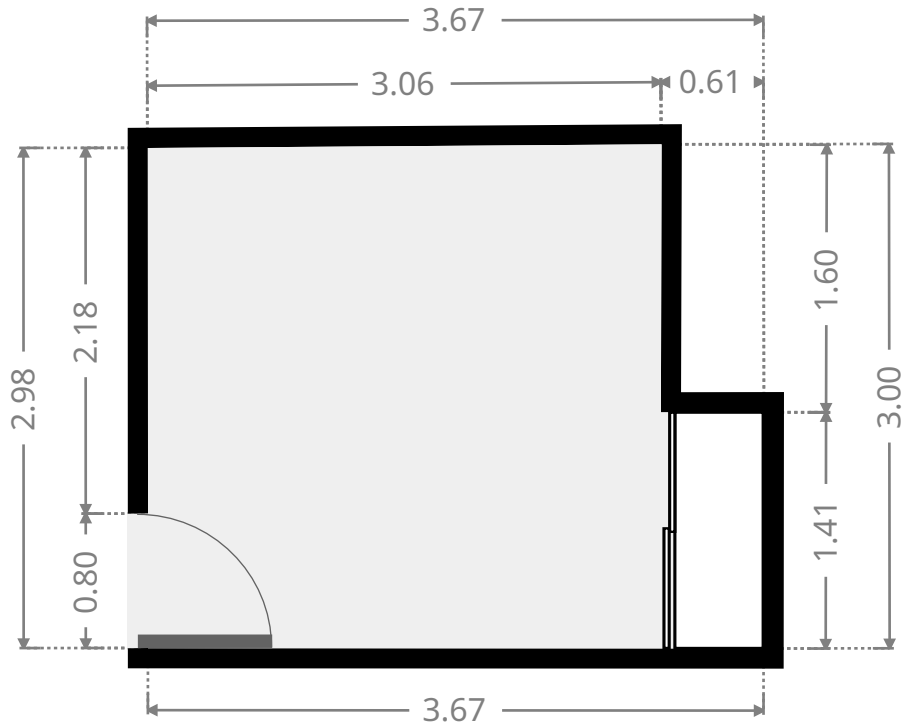
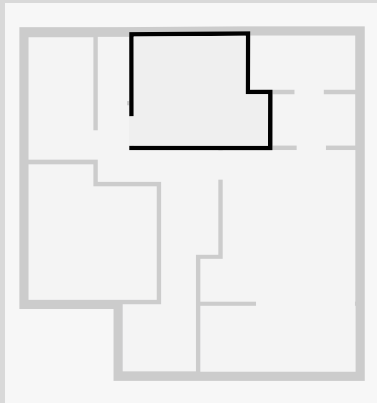

Stairway

Width: 2.00 m
 Length: 2.35 m
 Area: 4.16 m²
 Perimeter: 8.70 m

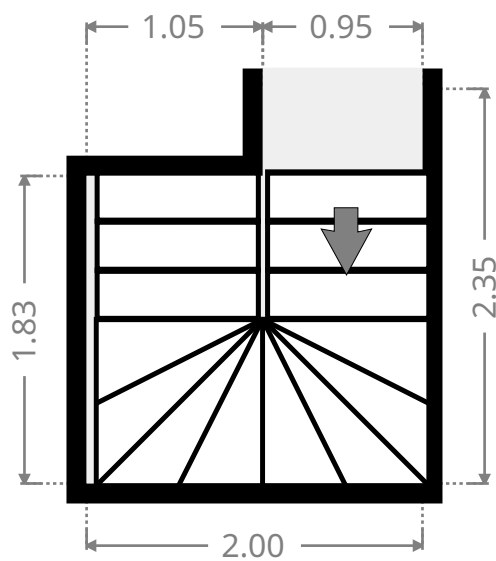
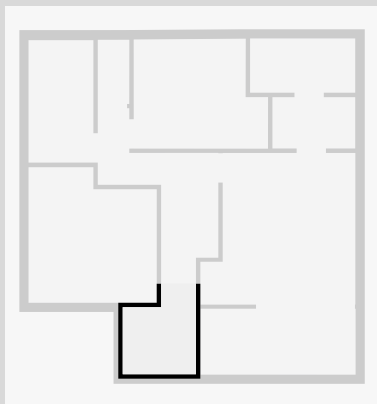

THIS FLOORPLAN IS PROVIDED WITHOUT WARRANTY OF ANY KIND. SENSOPIA DISCLAIMS ANY WARRANTY INCLUDING, WITHOUT LIMITATION, SATISFACTORY QUALITY OR ACCURACY OF DIMENSIONS.

