

# Unit 1/21 Price Avenue

Created on  
2020-08-12

Floors  
1

▼ Ground Floor

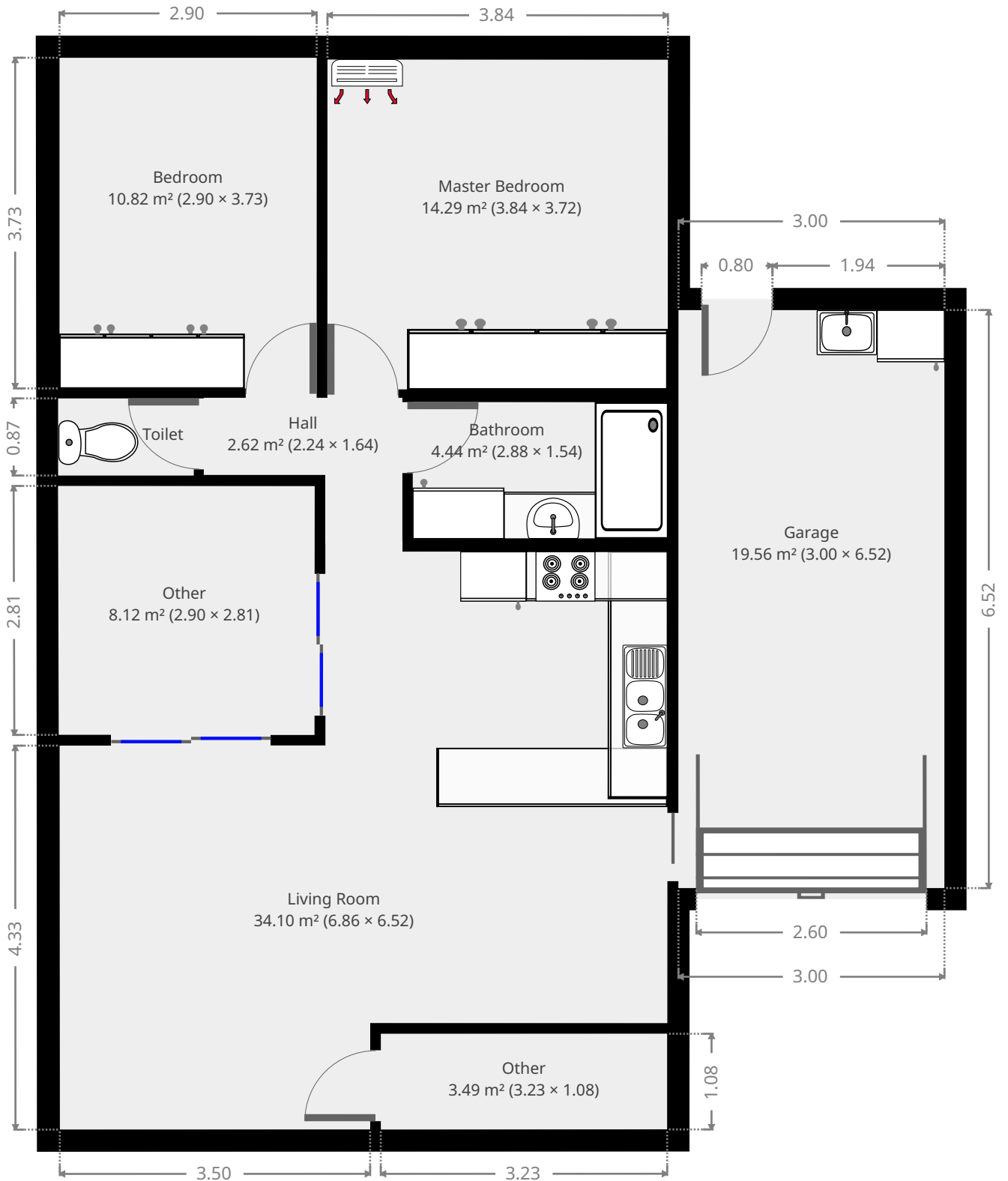

THIS FLOORPLAN IS PROVIDED WITHOUT WARRANTY OF ANY KIND. SENSOPIA DISCLAIMS ANY WARRANTY INCLUDING, WITHOUT LIMITATION, SATISFACTORY QUALITY OR ACCURACY OF DIMENSIONS.

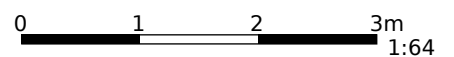

▼ **Living Room**  
Ground Floor

**WIDTH:** 6.86 m • **LENGTH:** 6.52 m  
**AREA:** 34.10 m<sup>2</sup> • **PERIMETER:** 26.75 m

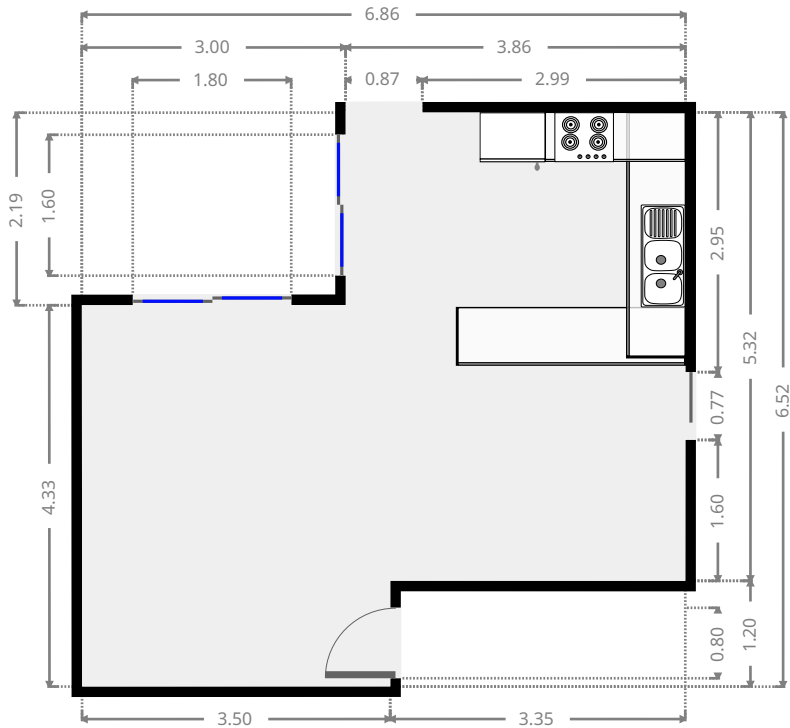
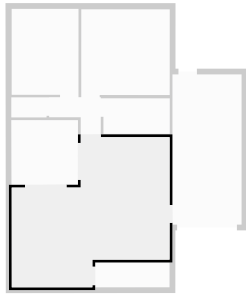

▼ **Hall**  
Ground Floor

**WIDTH:** 2.24 m • **LENGTH:** 1.64 m  
**AREA:** 2.62 m<sup>2</sup> • **PERIMETER:** 7.76 m

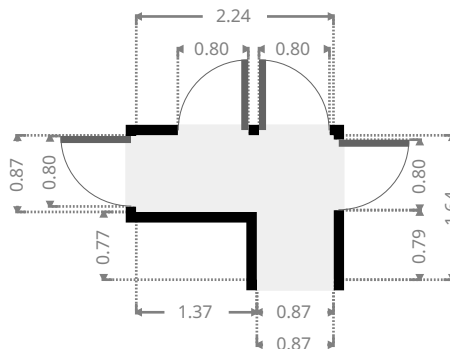

FLOORS: 1

▼ **Bathroom**  
Ground Floor

WIDTH: 2.88 m • LENGTH: 1.54 m  
AREA: 4.44 m<sup>2</sup> • PERIMETER: 8.84 m

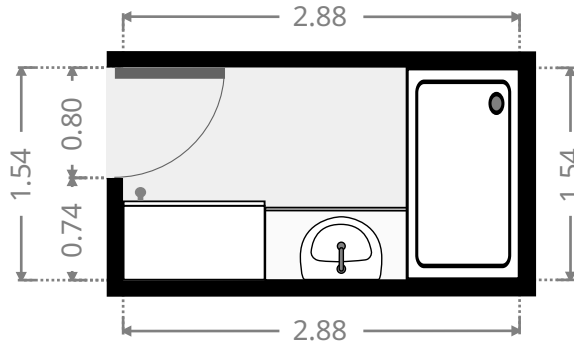
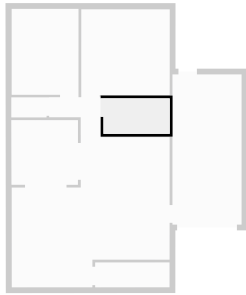

▼ **Master Bedroom**  
Ground Floor

WIDTH: 3.84 m • LENGTH: 3.72 m  
AREA: 14.29 m<sup>2</sup> • PERIMETER: 15.12 m

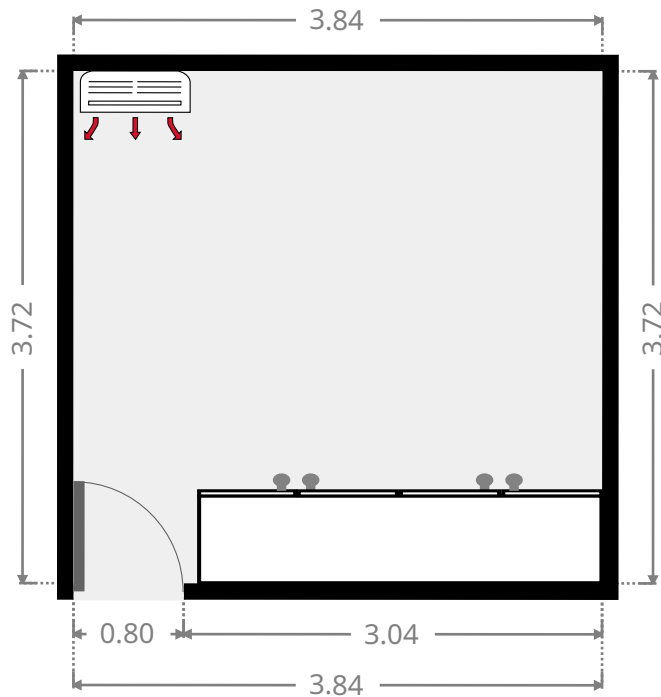
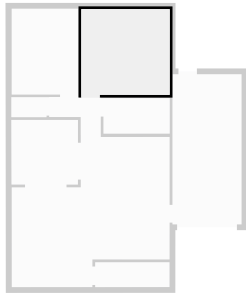

FLOORS: 1

▼ **Toilet**  
Ground Floor

WIDTH: 1.53 m • LENGTH: 0.87 m  
AREA: 1.33 m<sup>2</sup> • PERIMETER: 4.80 m

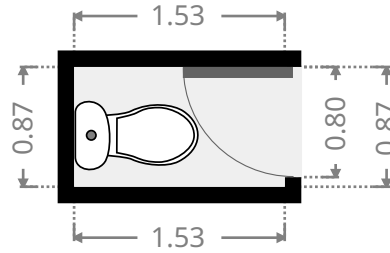
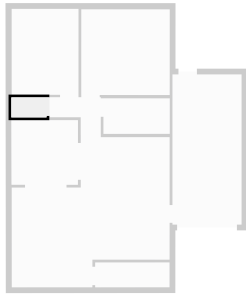

▼ **Bedroom**  
Ground Floor

WIDTH: 2.90 m • LENGTH: 3.73 m  
AREA: 10.82 m<sup>2</sup> • PERIMETER: 13.26 m

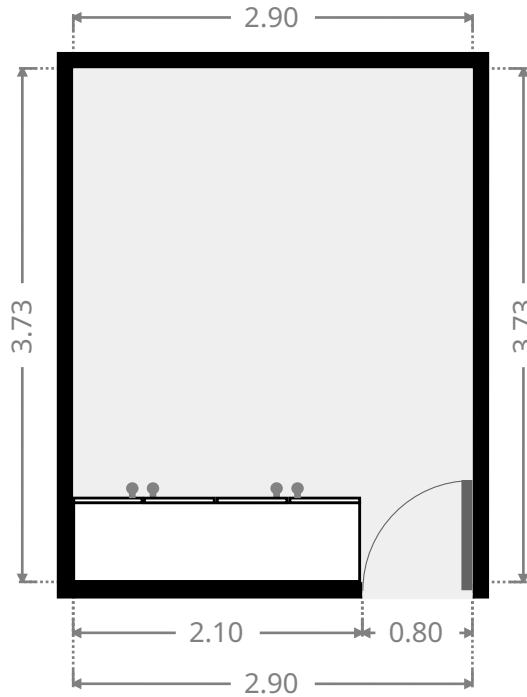
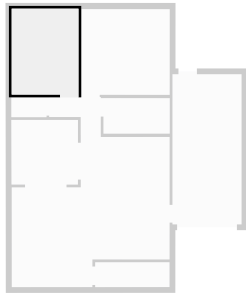

FLOORS: 1

▼ **Other**  
Ground Floor

**WIDTH:** 2.90 m • **LENGTH:** 2.81 m  
**AREA:** 8.12 m<sup>2</sup> • **PERIMETER:** 11.40 m

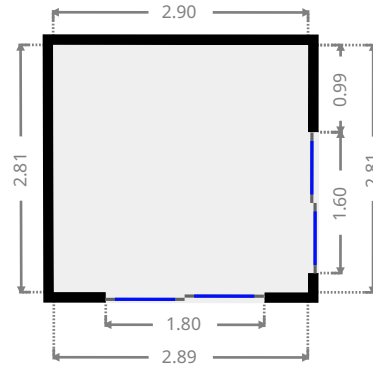
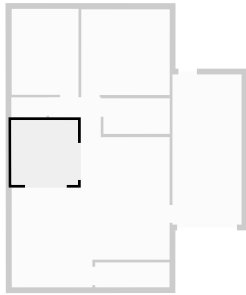

▼ **Garage**  
Ground Floor

**WIDTH:** 3.00 m • **LENGTH:** 6.52 m  
**AREA:** 19.56 m<sup>2</sup> • **PERIMETER:** 19.04 m

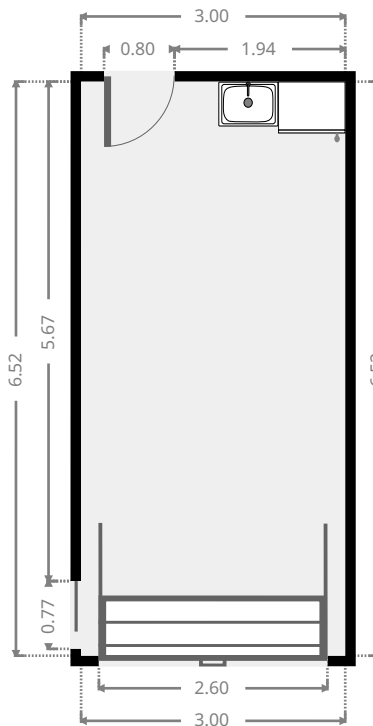
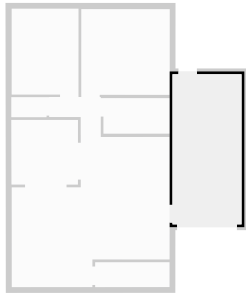

FLOORS: 1

▼ **Other**  
Ground Floor

**WIDTH:** 3.23 m • **LENGTH:** 1.08 m  
**AREA:** 3.49 m<sup>2</sup> • **PERIMETER:** 8.62 m

