

9a Neill Street

Created on
2020-07-28

Floors
2

▼ Ground Floor

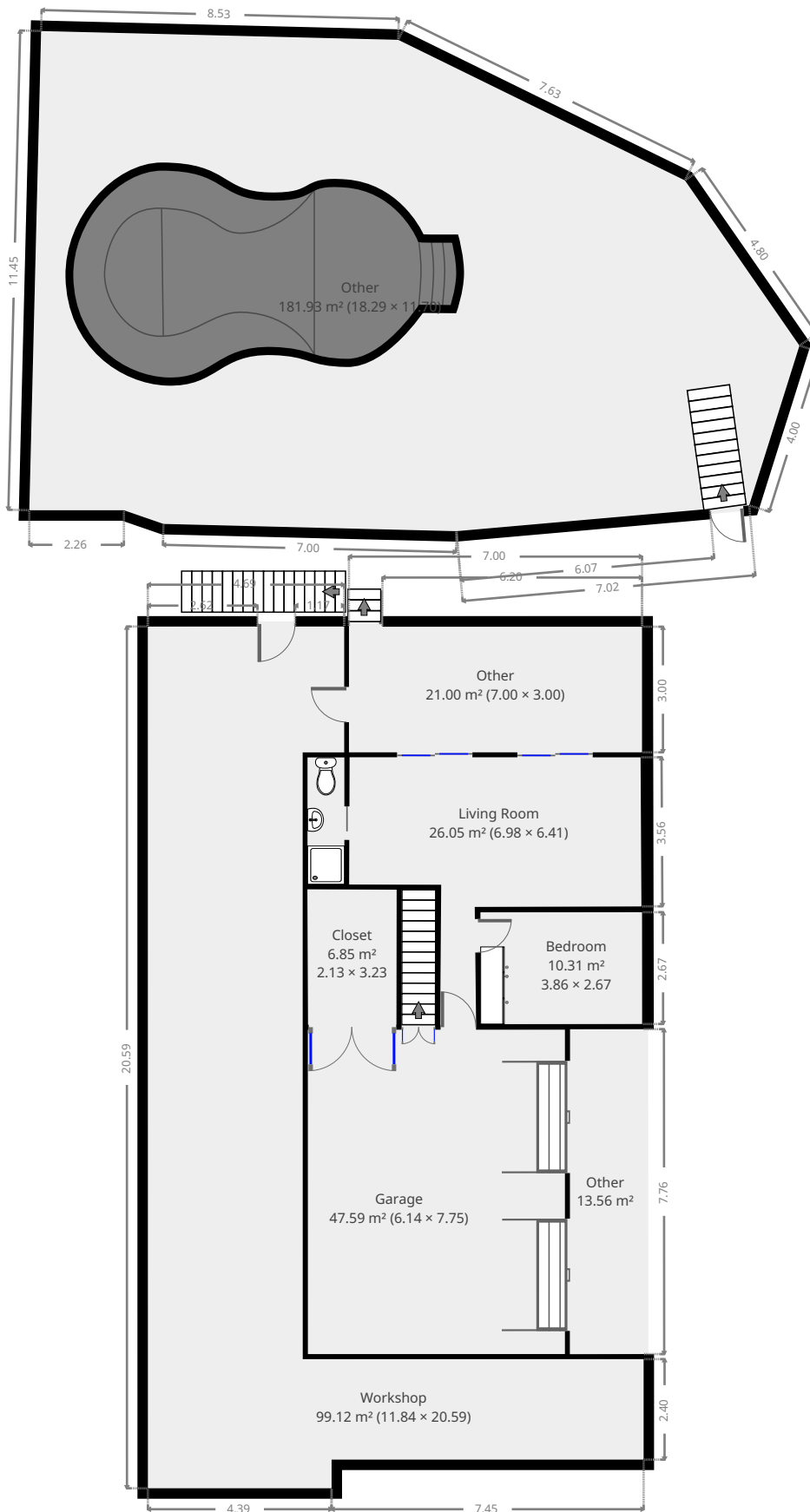

THIS FLOORPLAN IS PROVIDED WITHOUT WARRANTY OF ANY KIND. SENSOPIA DISCLAIMS ANY WARRANTY INCLUDING, WITHOUT LIMITATION, SATISFACTORY QUALITY OR ACCURACY OF DIMENSIONS.

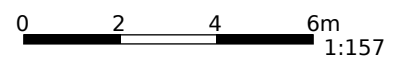

▼ **Garage**
Ground Floor

WIDTH: 6.14 m • **LENGTH:** 7.75 m
AREA: 47.59 m² • **PERIMETER:** 27.78 m

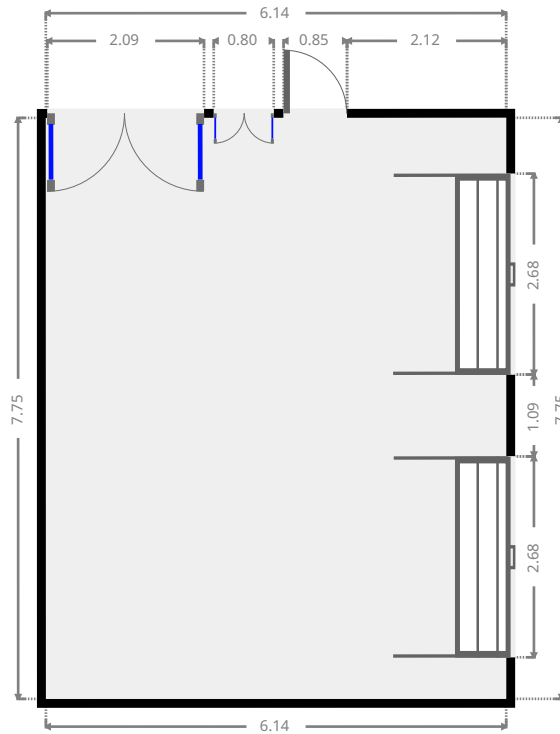
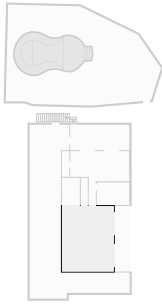

▼ **Bedroom**
Ground Floor

WIDTH: 3.86 m • **LENGTH:** 2.67 m
AREA: 10.31 m² • **PERIMETER:** 13.06 m

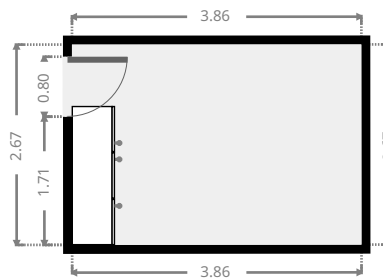
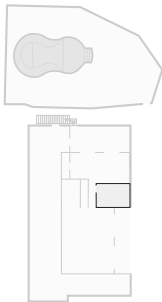

▼ Living Room
Ground Floor

WIDTH: 6.98 m • LENGTH: 6.41 m
AREA: 26.05 m² • PERIMETER: 26.77 m

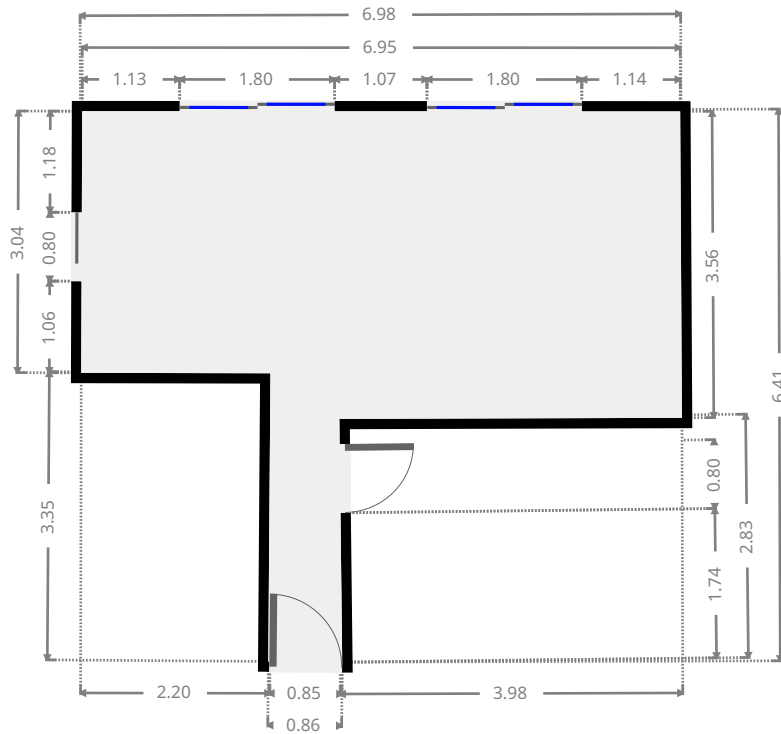
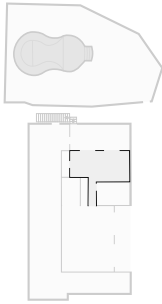

▼ Bathroom
Ground Floor

WIDTH: 0.88 m • LENGTH: 3.03 m
AREA: 2.67 m² • PERIMETER: 7.82 m

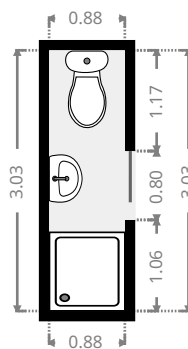
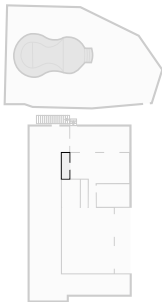

▼ **Stairway**
Ground Floor

WIDTH: 0.82 m • **LENGTH:** 3.23 m
AREA: 2.63 m² • **PERIMETER:** 8.09 m

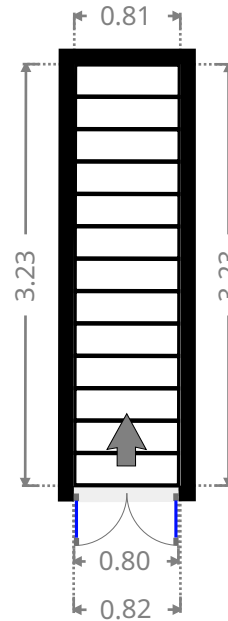
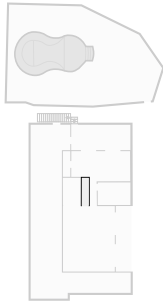

▼ **Closet**
Ground Floor

WIDTH: 2.13 m • **LENGTH:** 3.23 m
AREA: 6.85 m² • **PERIMETER:** 10.70 m

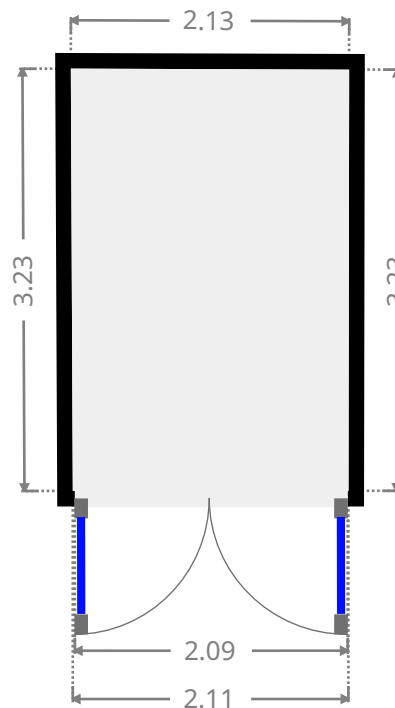
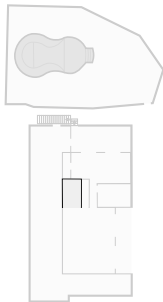

▼ Other Ground Floor

WIDTH: 7.00 m • **LENGTH:** 3.00 m
AREA: 21.00 m² • **PERIMETER:** 20.00 m

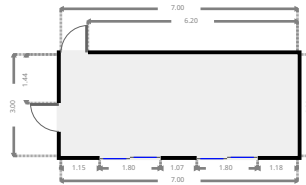
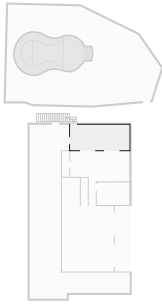

▼ Workshop Ground Floor

WIDTH: 11.84 m • **LENGTH:** 20.59 m
AREA: 99.12 m² • **PERIMETER:** 66.84 m

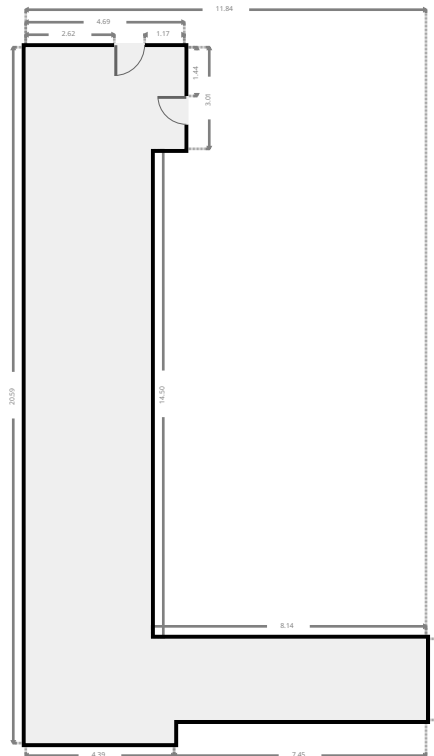
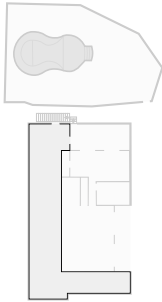

▼ Other Ground Floor

WIDTH: 18.29 m • LENGTH: 11.70 m
AREA: 181.93 m² • PERIMETER: 53.69 m

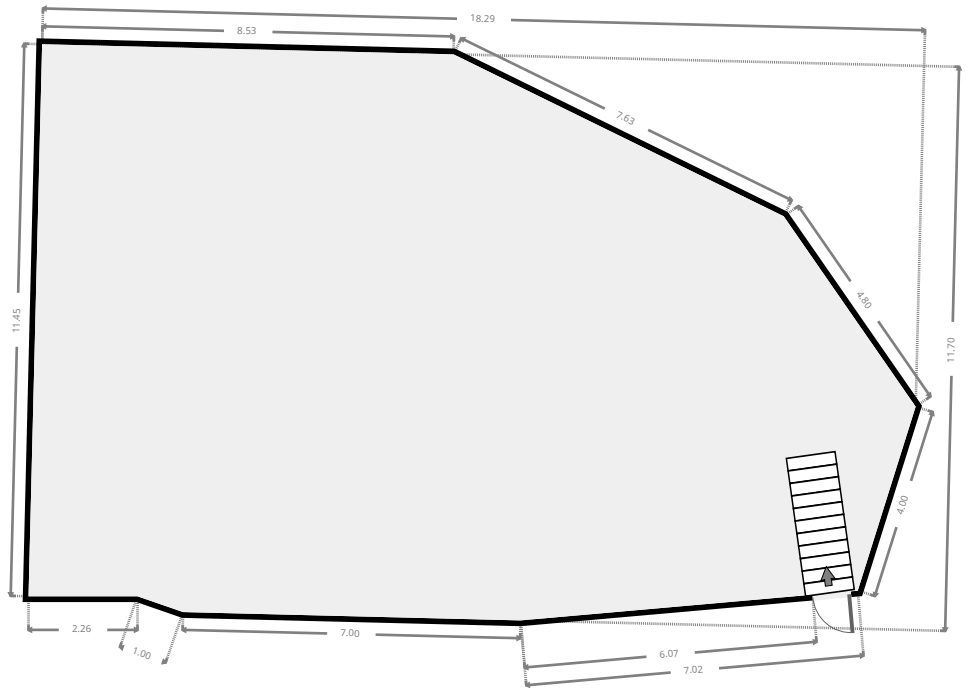
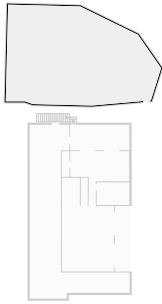

▼ Other Ground Floor

WIDTH: 1.76 m • LENGTH: 7.76 m
AREA: 13.56 m² • PERIMETER: 19.02 m

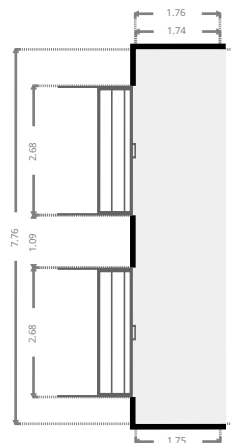
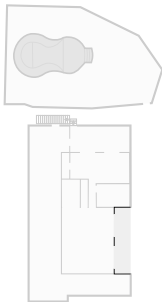

▼ 1st Floor



FLOORS: 2

▼ **Bedroom**
1st Floor

WIDTH: 4.65 m • LENGTH: 3.27 m
AREA: 15.20 m² • PERIMETER: 15.84 m

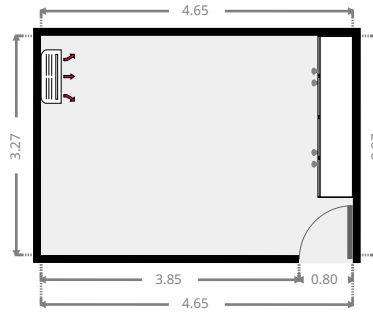
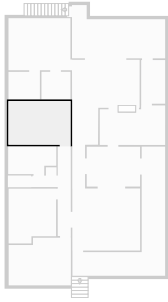

▼ **Other**
1st Floor

WIDTH: 6.95 m • LENGTH: 9.68 m
AREA: 26.19 m² • PERIMETER: 33.25 m

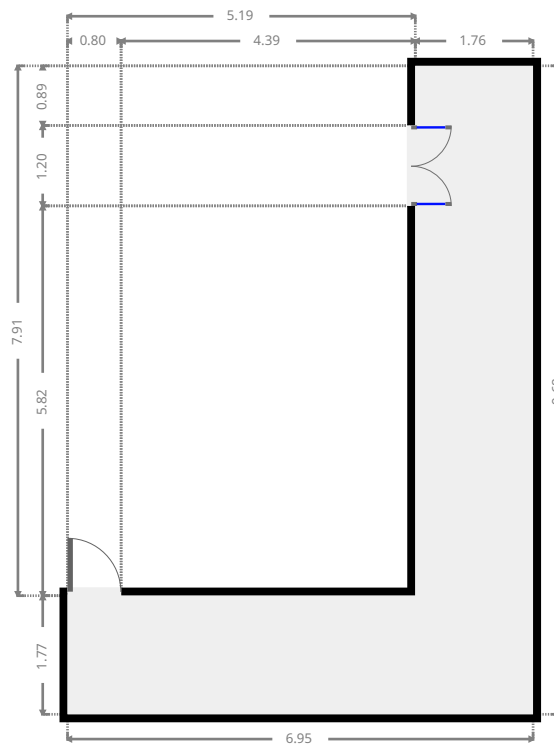
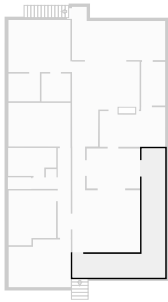

THIS FLOORPLAN IS PROVIDED WITHOUT WARRANTY OF ANY KIND. SENSOPIA DISCLAIMS ANY WARRANTY INCLUDING, WITHOUT LIMITATION, SATISFACTORY QUALITY OR ACCURACY OF DIMENSIONS.



FLOORS: 2

▼ **Other**
1st Floor

WIDTH: 6.98 m • LENGTH: 3.99 m
AREA: 21.63 m² • PERIMETER: 21.95 m

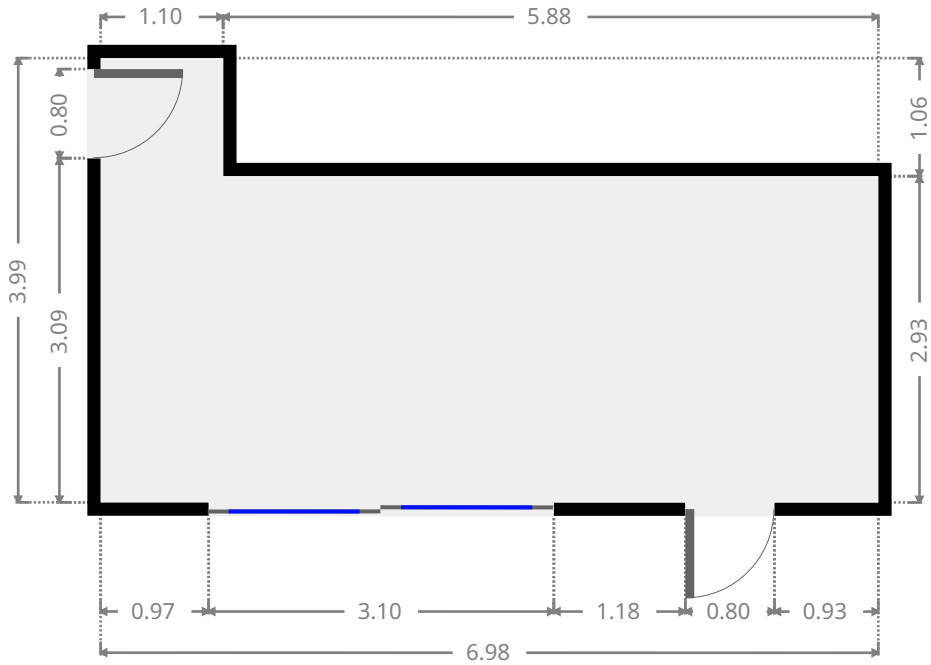
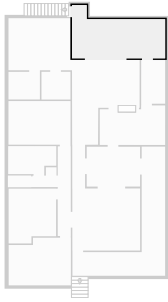

▼ **Bathroom**
1st Floor

WIDTH: 2.35 m • LENGTH: 2.07 m
AREA: 4.87 m² • PERIMETER: 8.85 m

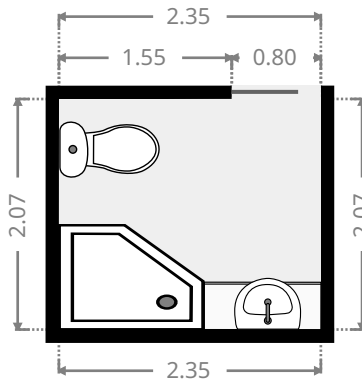
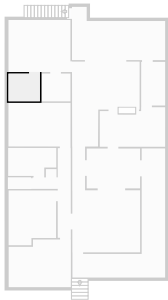

▼ **Closet**
1st Floor

WIDTH: 2.17 m • **LENGTH:** 2.08 m
AREA: 4.51 m² • **PERIMETER:** 8.50 m

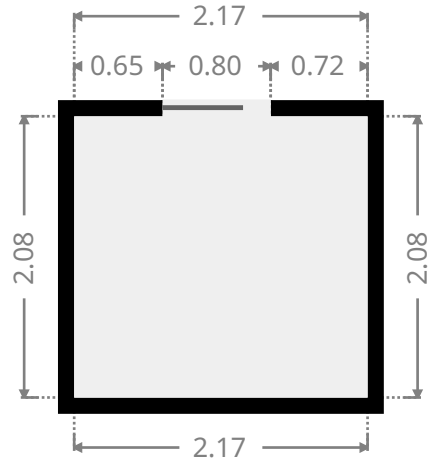
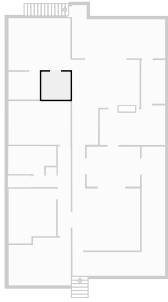

▼ **Master Bedroom**
1st Floor

WIDTH: 4.64 m • **LENGTH:** 3.90 m
AREA: 18.10 m² • **PERIMETER:** 17.08 m

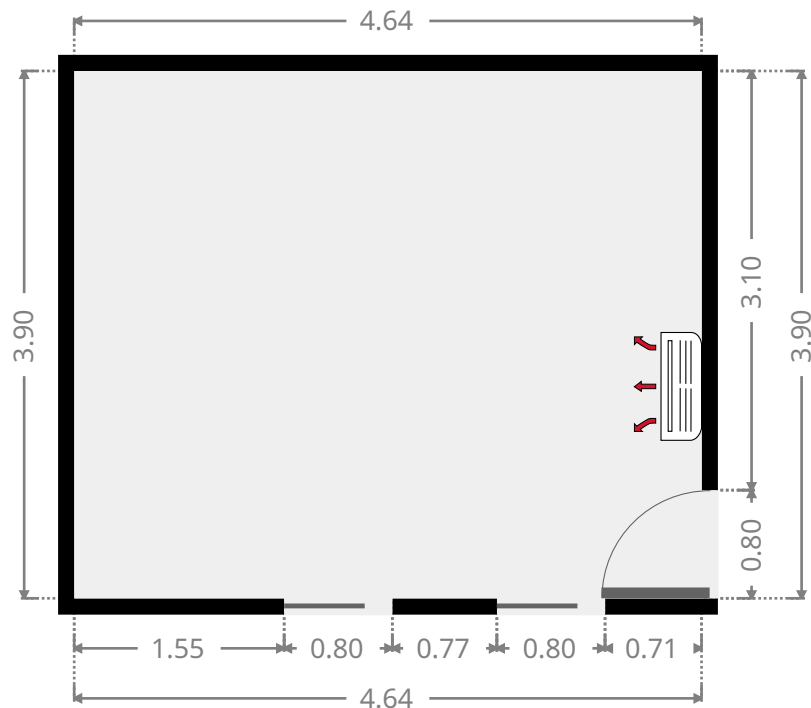
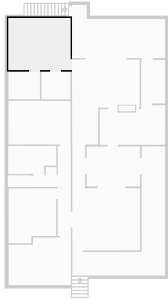

▼ **Laundry Room**
1st Floor

WIDTH: 1.80 m • LENGTH: 3.27 m
AREA: 5.87 m² • PERIMETER: 10.13 m

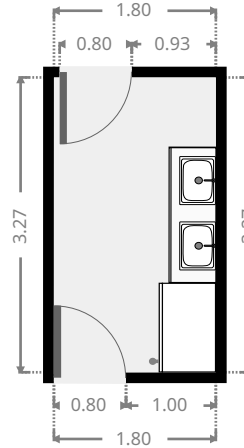
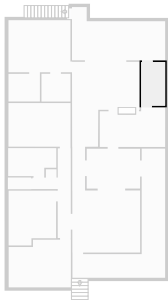

▼ **Living Room**
1st Floor

WIDTH: 5.07 m • LENGTH: 6.38 m
AREA: 23.64 m² • PERIMETER: 22.85 m

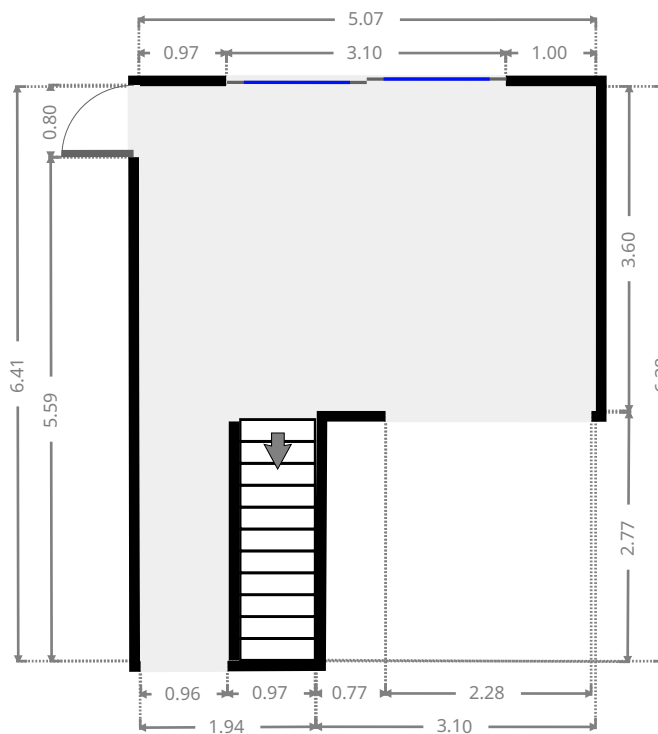
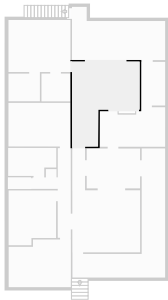

▼ **Kitchen**
1st Floor

WIDTH: 4.90 m • LENGTH: 2.96 m
AREA: 13.61 m² • PERIMETER: 15.72 m

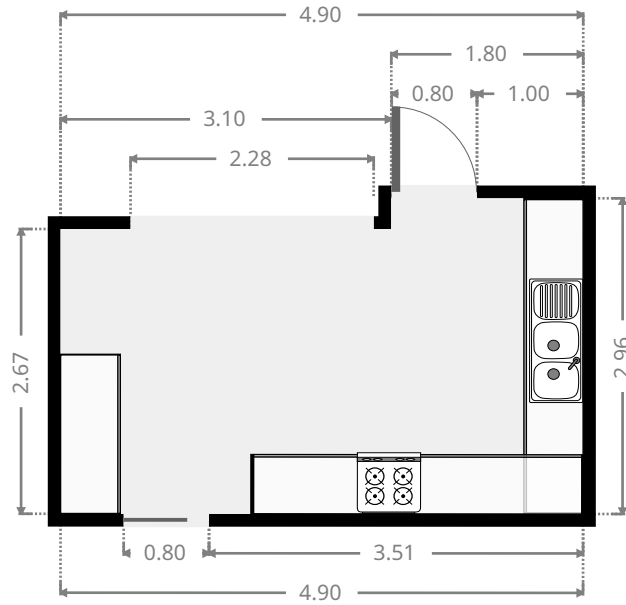
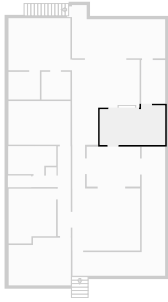

▼ **Living Room**
1st Floor

WIDTH: 5.08 m • LENGTH: 4.65 m
AREA: 23.62 m² • PERIMETER: 19.46 m

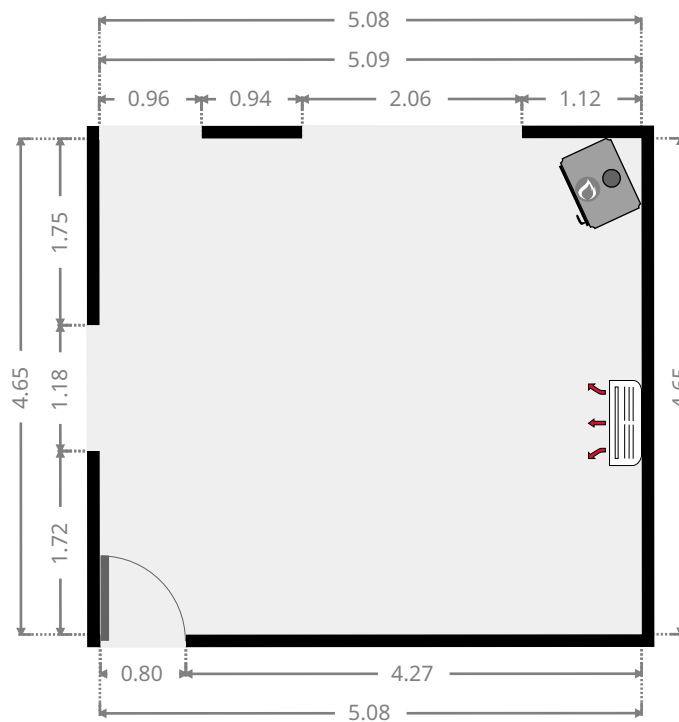
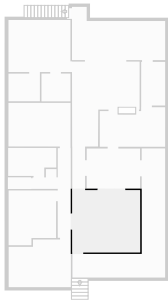

▼ **Bathroom**
1st Floor

WIDTH: 3.60 m • LENGTH: 2.10 m
AREA: 7.00 m² • PERIMETER: 11.41 m

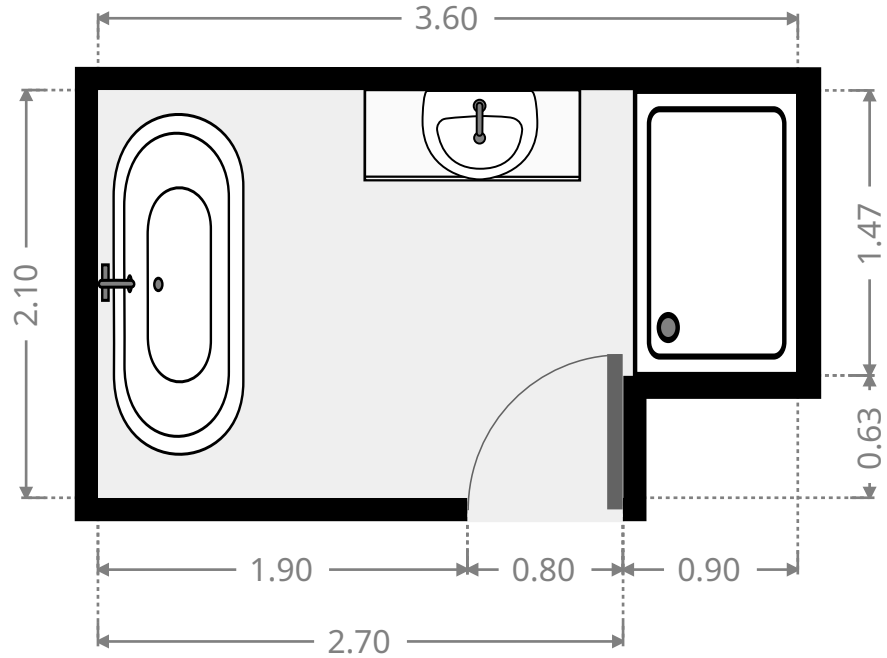
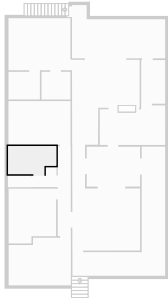

▼ **Toilet**
1st Floor

WIDTH: 1.75 m • LENGTH: 0.88 m
AREA: 1.54 m² • PERIMETER: 5.26 m

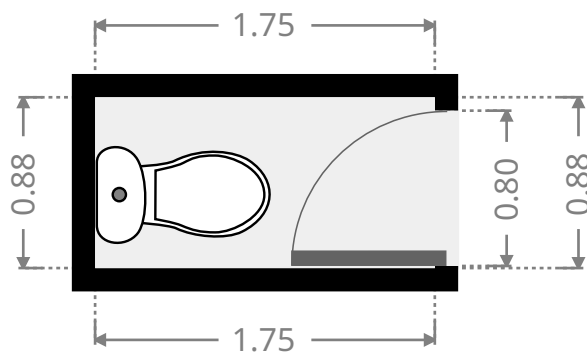
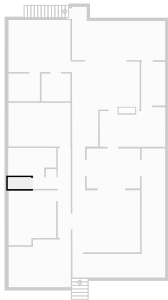

FLOORS: 2

▼ **Hall**
1st Floor

WIDTH: 1.80 m • LENGTH: 1.48 m
AREA: 2.05 m² • PERIMETER: 6.56 m

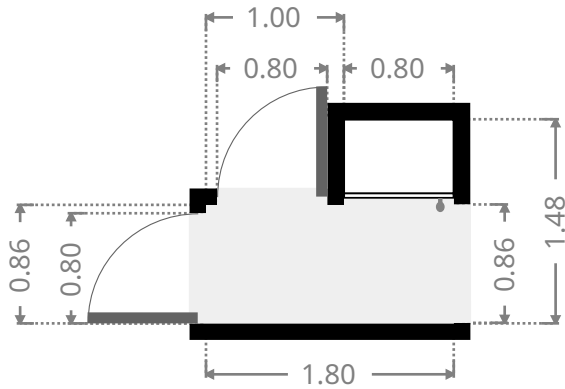
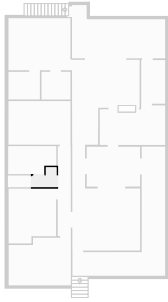

▼ **Bedroom**
1st Floor

WIDTH: 3.56 m • LENGTH: 4.11 m
AREA: 13.62 m² • PERIMETER: 15.33 m

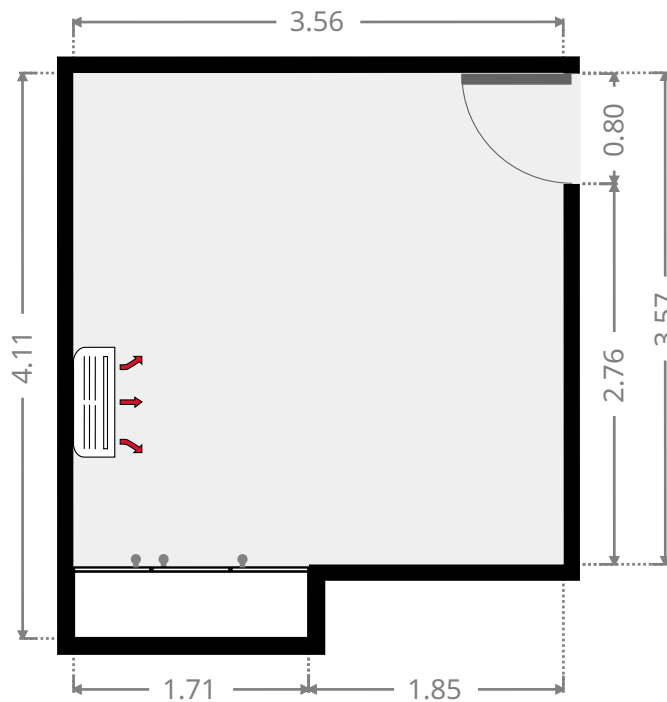
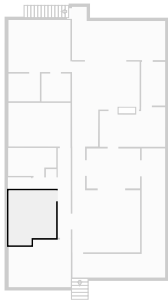

▼ Bedroom 1st Floor

WIDTH: 4.66 m • LENGTH: 3.57 m
AREA: 15.64 m² • PERIMETER: 16.46 m

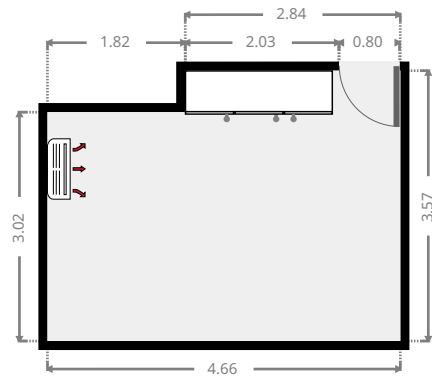
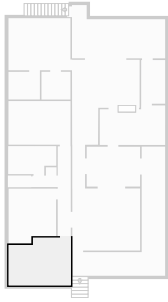

▼ Hall 1st Floor

WIDTH: 0.98 m • LENGTH: 6.72 m
AREA: 6.56 m² • PERIMETER: 15.39 m

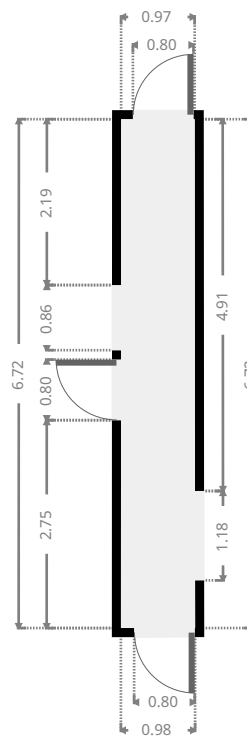
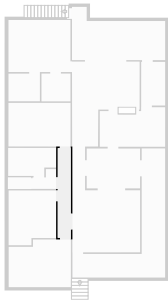

▼ Dining Room
1st Floor

WIDTH: 4.00 m • LENGTH: 2.99 m
AREA: 11.93 m² • PERIMETER: 13.97 m

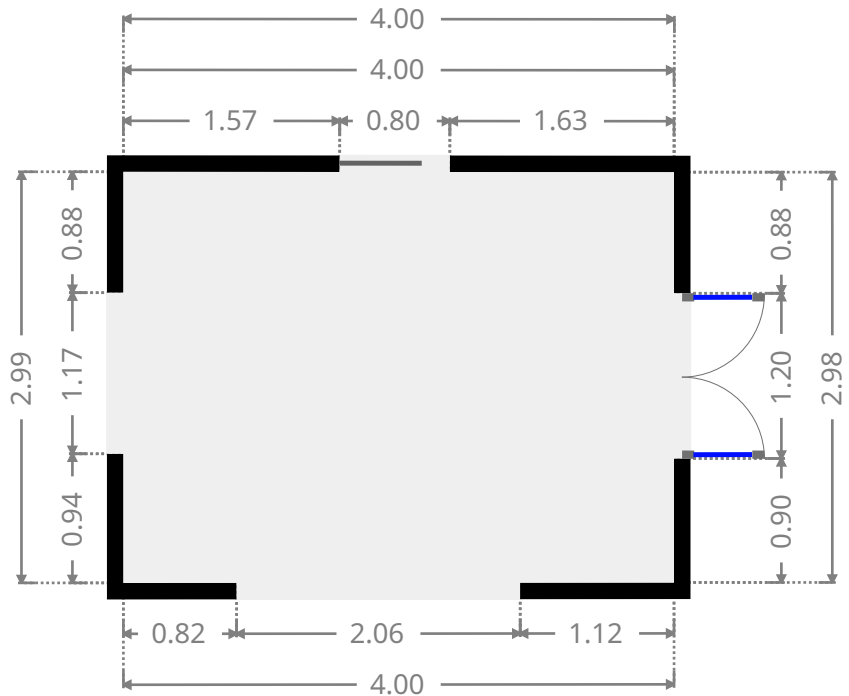
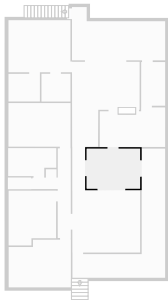

▼ Hall
1st Floor

WIDTH: 0.96 m • LENGTH: 3.08 m
AREA: 2.96 m² • PERIMETER: 8.08 m

