

# 99 Buzacott Street

Created on  
2021-03-29

Floors  
1

▼ Ground Floor

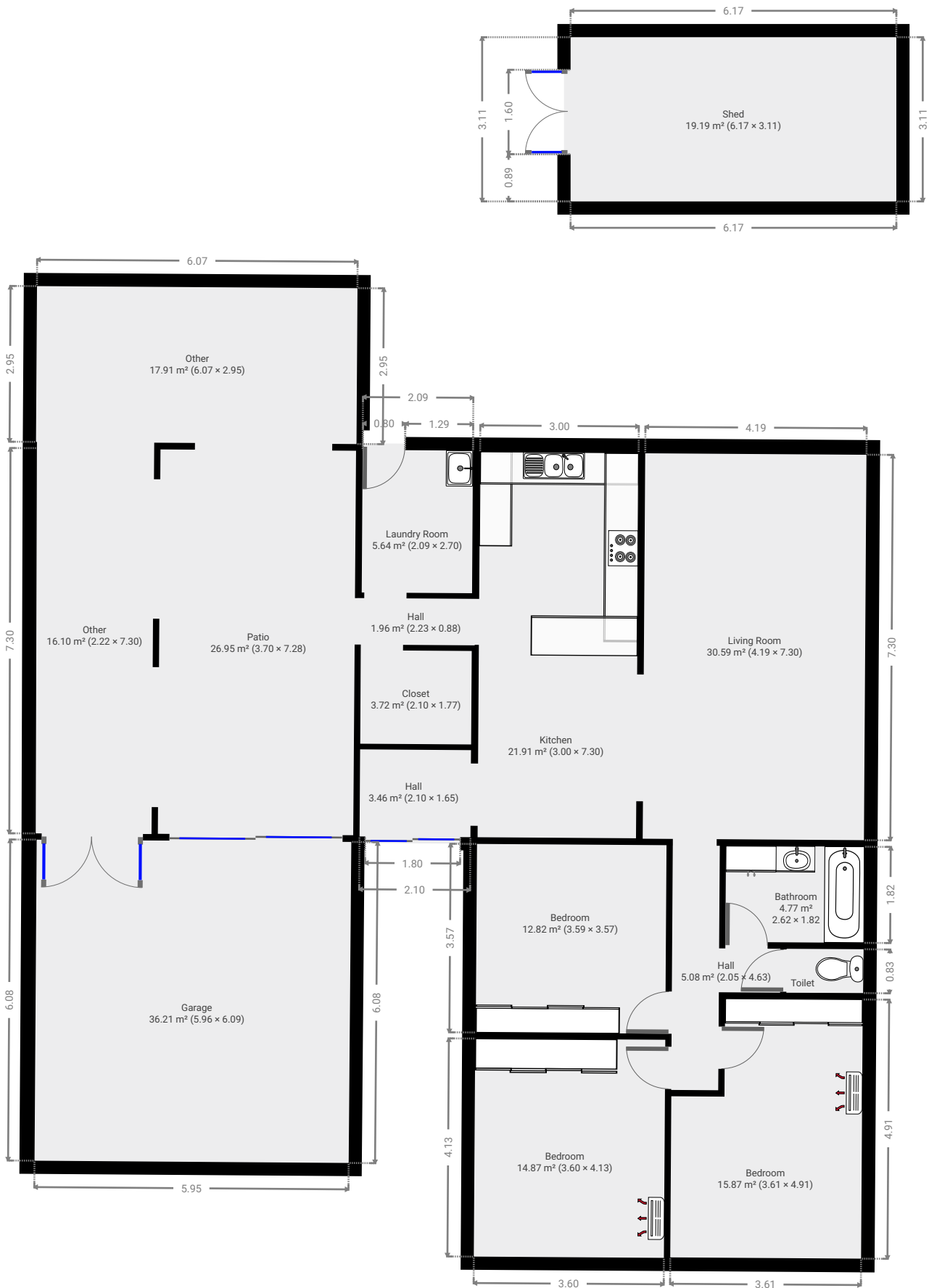

▼ **Bedroom**  
Ground Floor

WIDTH: 3.59 m • LENGTH: 3.57 m  
AREA: 12.82 m<sup>2</sup> • PERIMETER: 14.32 m

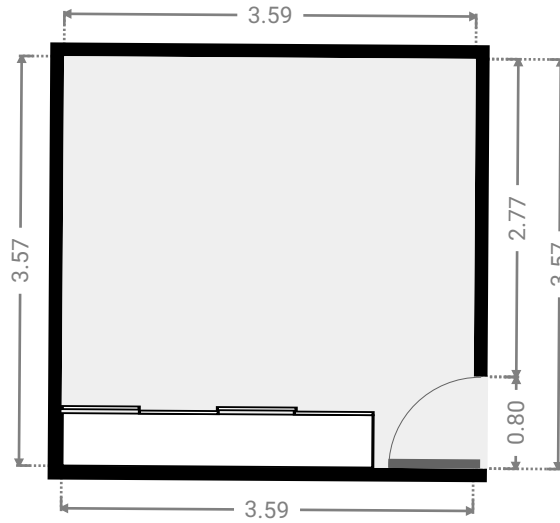
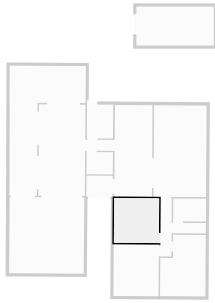

▼ **Shed**  
Ground Floor

WIDTH: 6.17 m • LENGTH: 3.11 m  
AREA: 19.19 m<sup>2</sup> • PERIMETER: 18.56 m

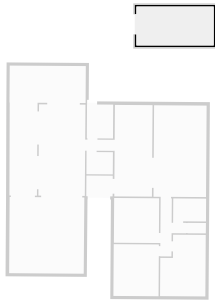

▼ Other  
Ground Floor

WIDTH: 2.22 m • LENGTH: 7.30 m  
AREA: 16.10 m<sup>2</sup> • PERIMETER: 19.00 m

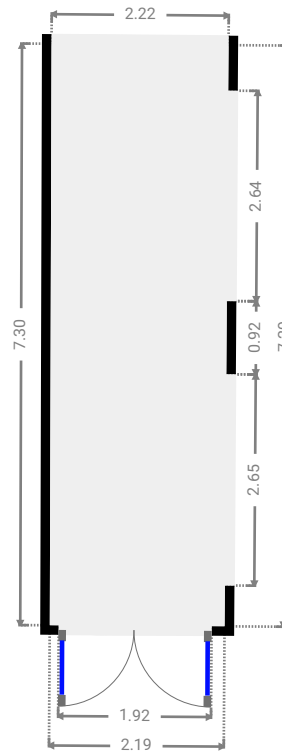
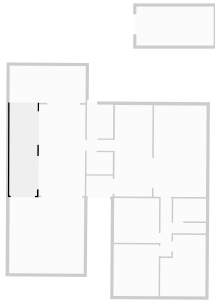

▼ Garage  
Ground Floor

WIDTH: 5.96 m • LENGTH: 6.09 m  
AREA: 36.21 m<sup>2</sup> • PERIMETER: 24.07 m

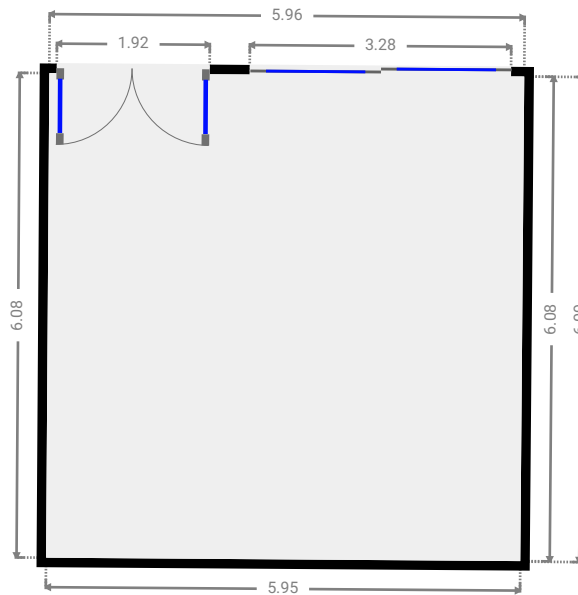

▼ Other  
Ground Floor

WIDTH: 6.07 m • LENGTH: 2.95 m  
AREA: 17.91 m<sup>2</sup> • PERIMETER: 18.04 m

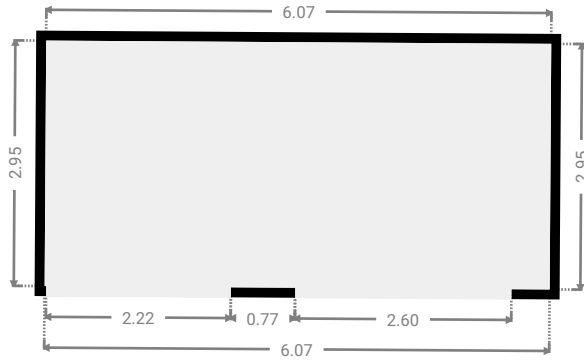
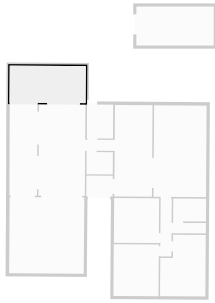

▼ Patio  
Ground Floor

WIDTH: 3.70 m • LENGTH: 7.28 m  
AREA: 26.95 m<sup>2</sup> • PERIMETER: 21.97 m

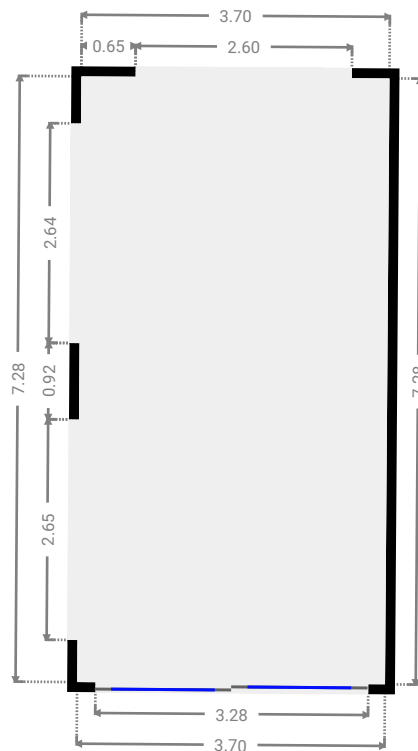
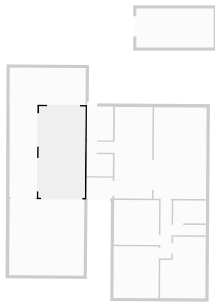

▼ Laundry Room  
Ground Floor

WIDTH: 2.09 m • LENGTH: 2.70 m  
AREA: 5.64 m<sup>2</sup> • PERIMETER: 9.58 m

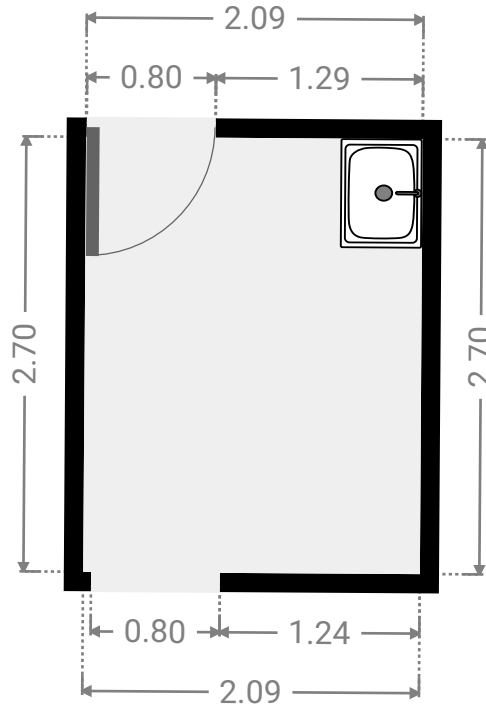

▼ Hall  
Ground Floor

WIDTH: 2.23 m • LENGTH: 0.88 m  
AREA: 1.96 m<sup>2</sup> • PERIMETER: 6.22 m

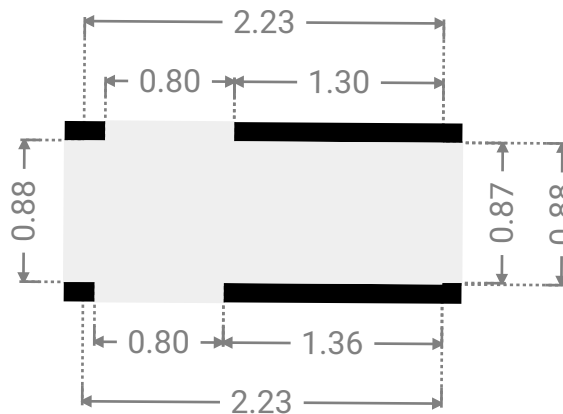
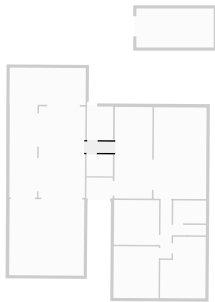

▼ **Closet**  
Ground Floor

WIDTH: 2.10 m • LENGTH: 1.77 m  
AREA: 3.72 m<sup>2</sup> • PERIMETER: 7.74 m

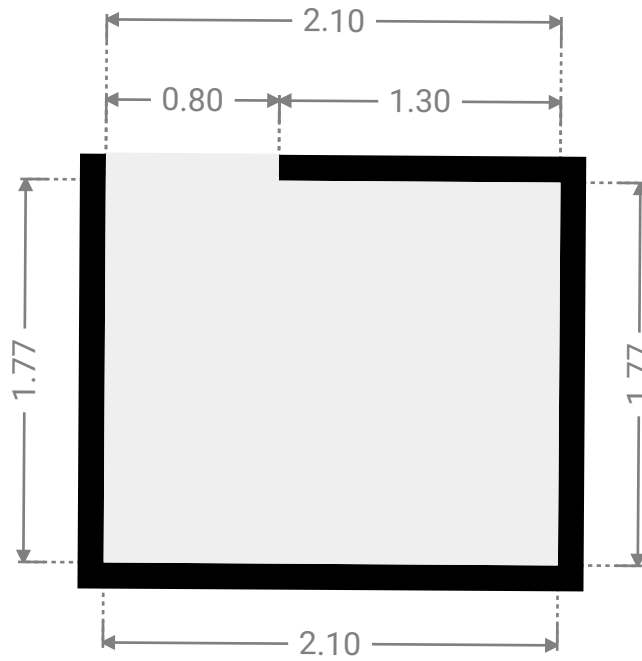
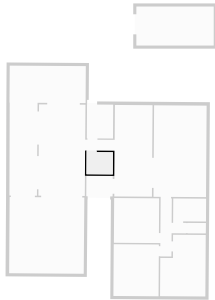

▼ **Hall**  
Ground Floor

WIDTH: 2.10 m • LENGTH: 1.65 m  
AREA: 3.46 m<sup>2</sup> • PERIMETER: 7.50 m

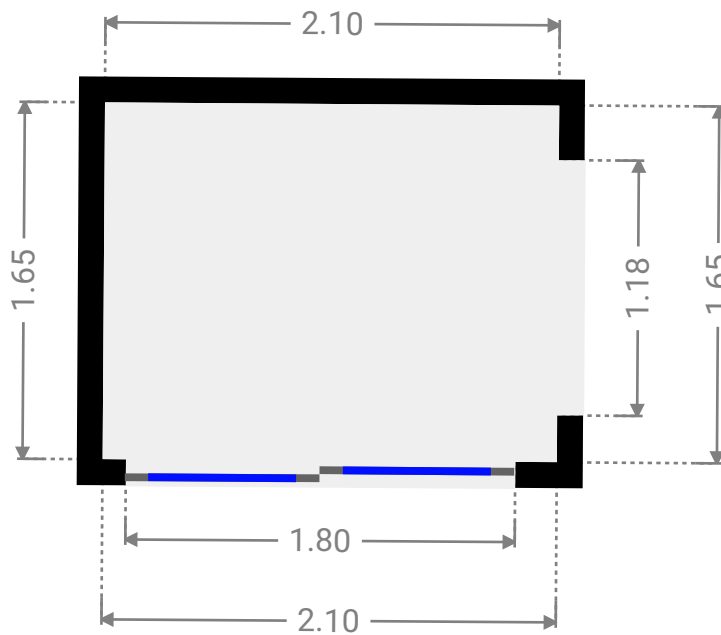
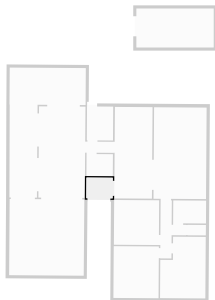

▼ **Bedroom**  
Ground Floor

WIDTH: 3.60 m • LENGTH: 4.13 m  
AREA: 14.87 m<sup>2</sup> • PERIMETER: 15.46 m

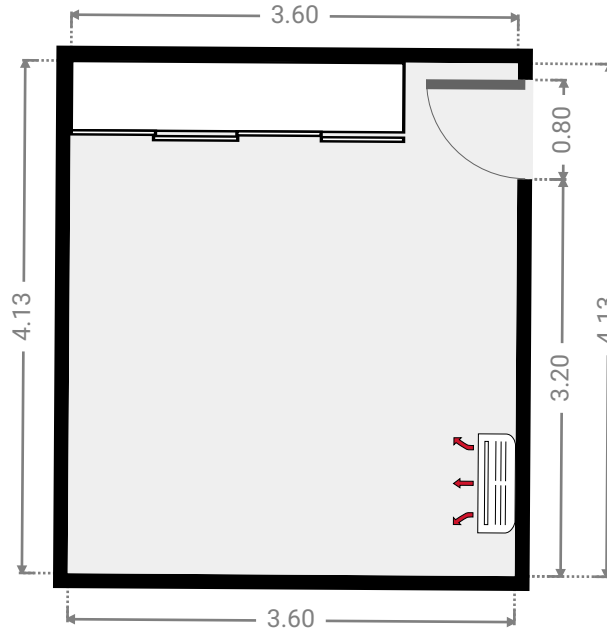

▼ **Bedroom**  
Ground Floor

WIDTH: 3.61 m • LENGTH: 4.91 m  
AREA: 15.87 m<sup>2</sup> • PERIMETER: 17.04 m

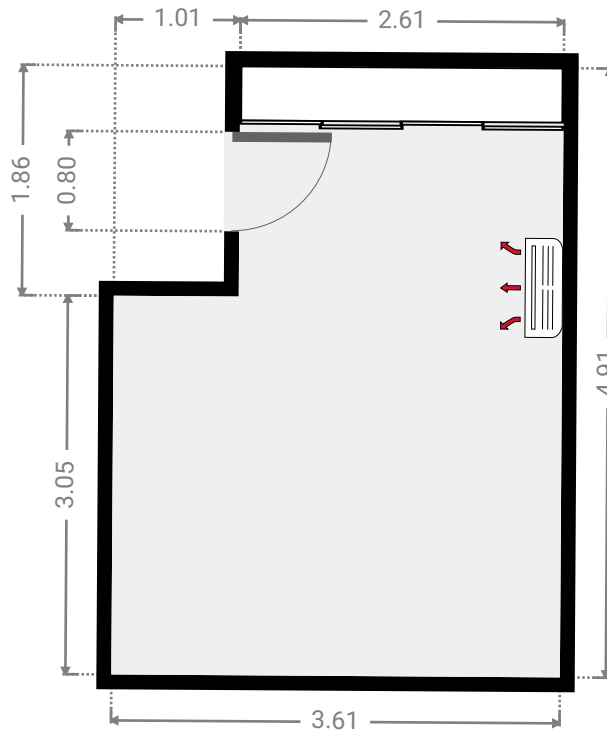
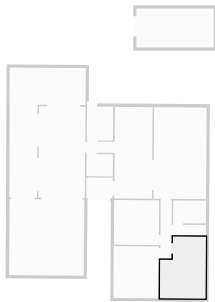



▼ Toilet  
Ground Floor

WIDTH: 1.46 m • LENGTH: 0.83 m  
AREA: 1.21 m<sup>2</sup> • PERIMETER: 4.57 m

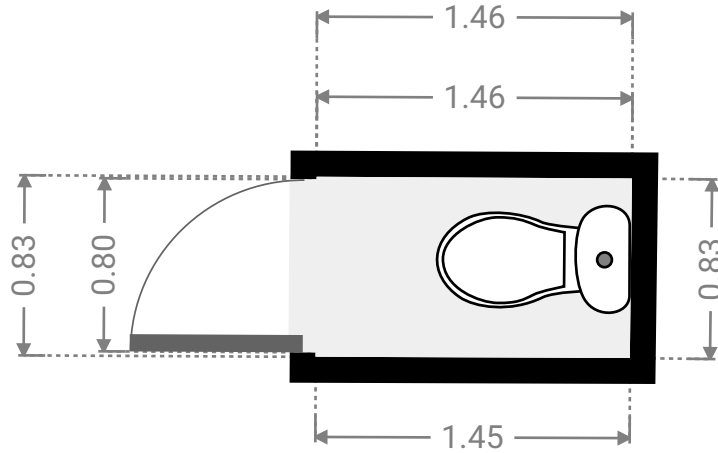

▼ Bathroom  
Ground Floor

WIDTH: 2.62 m • LENGTH: 1.82 m  
AREA: 4.77 m<sup>2</sup> • PERIMETER: 8.88 m

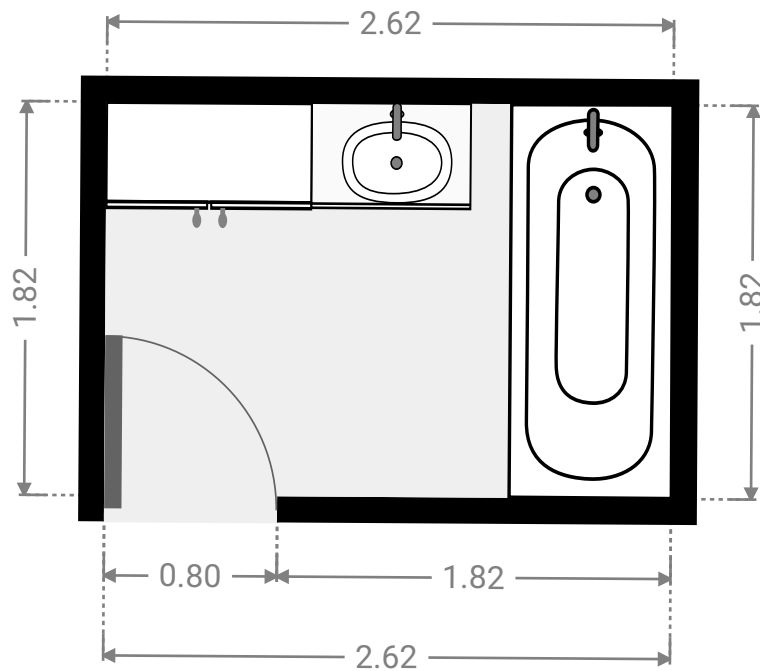
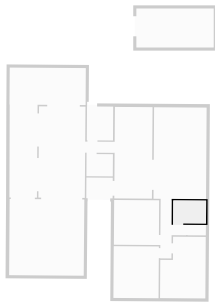

▼ **Hall**  
Ground Floor

WIDTH: 2.05 m • LENGTH: 4.63 m  
AREA: 5.08 m<sup>2</sup> • PERIMETER: 13.36 m

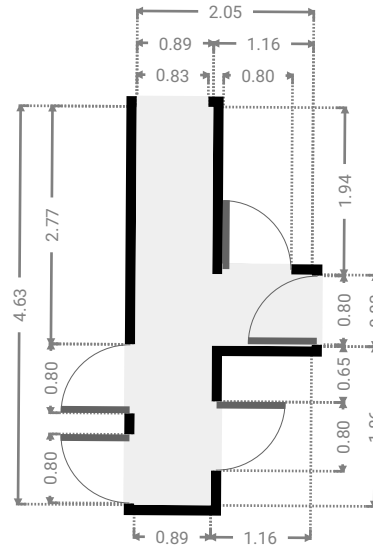
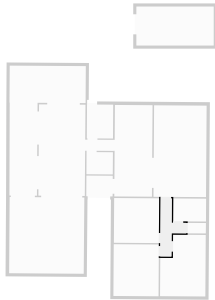

▼ **Living Room**  
Ground Floor

WIDTH: 4.19 m • LENGTH: 7.30 m  
AREA: 30.59 m<sup>2</sup> • PERIMETER: 22.98 m

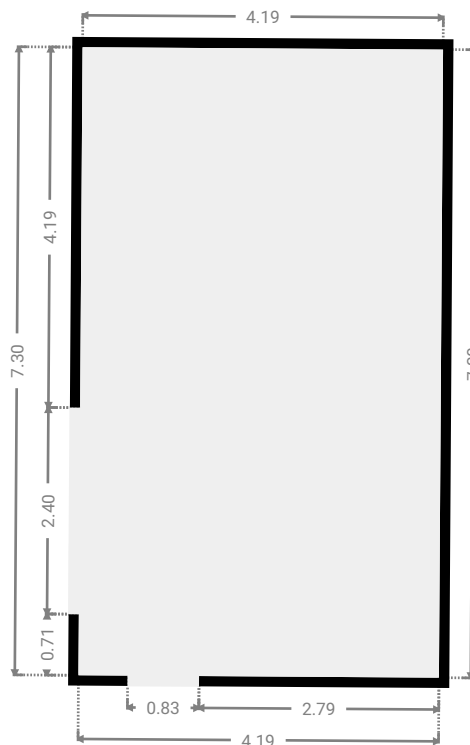
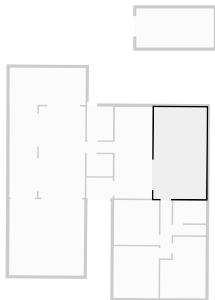

▼ **Kitchen**  
Ground Floor

WIDTH: 3.00 m • LENGTH: 7.30 m  
AREA: 21.91 m<sup>2</sup> • PERIMETER: 20.60 m

