

93 Mulgadoo Road

Created on
2021-08-24

Floors
1

▼ Ground Floor

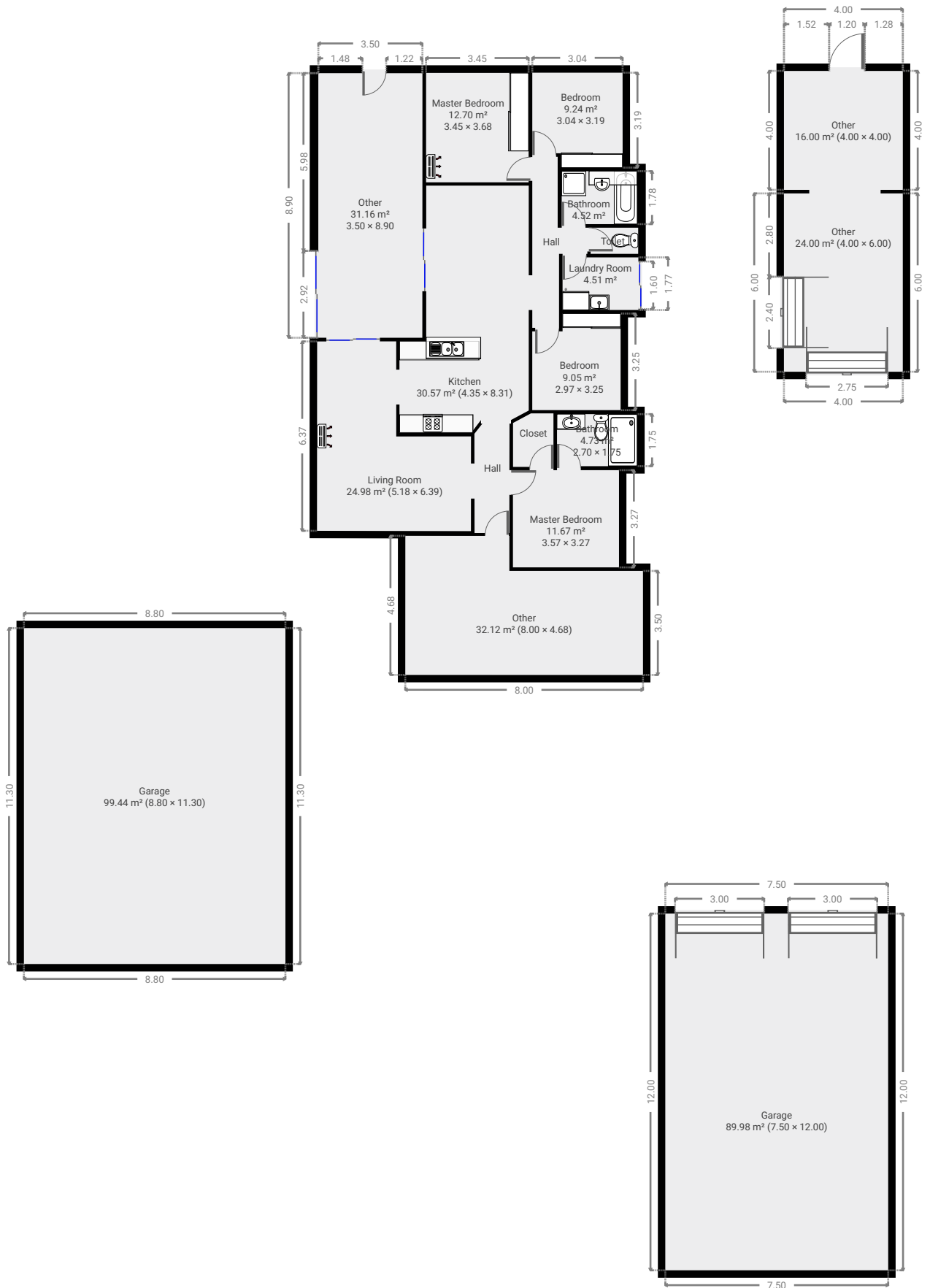

▼ Toilet
Ground Floor

WIDTH: 1.60 m • LENGTH: 0.88 m
AREA: 1.41 m² • PERIMETER: 4.96 m

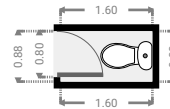
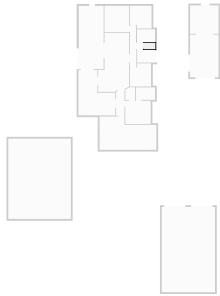

▼ Garage
Ground Floor

WIDTH: 7.50 m • LENGTH: 12.00 m
AREA: 89.98 m² • PERIMETER: 39.00 m

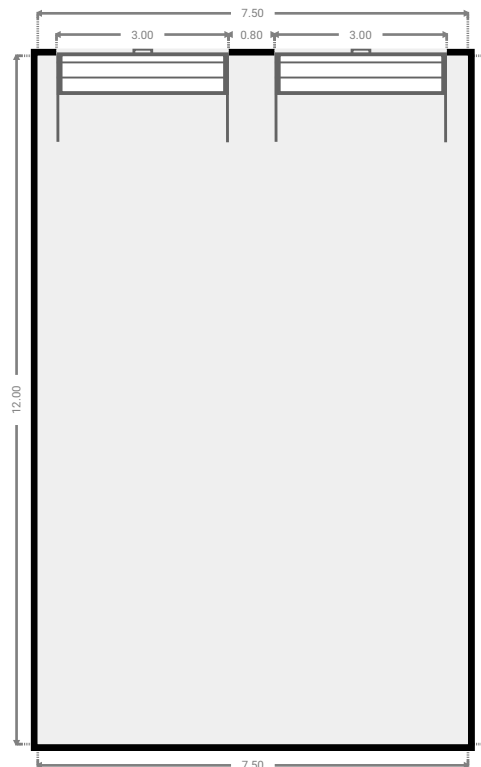
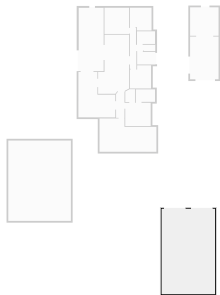

▼ Other
Ground Floor

WIDTH: 4.00 m • LENGTH: 4.00 m
AREA: 16.00 m² • PERIMETER: 16.00 m

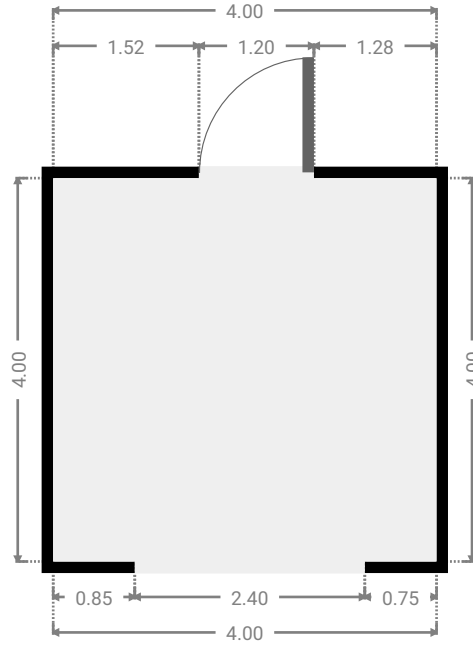
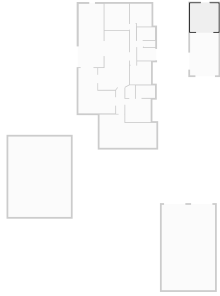

▼ Other
Ground Floor

WIDTH: 4.00 m • LENGTH: 6.00 m
AREA: 24.00 m² • PERIMETER: 20.00 m

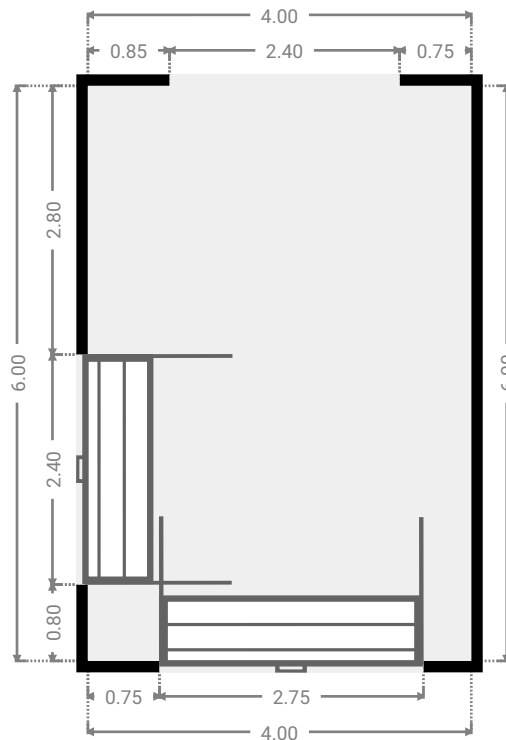
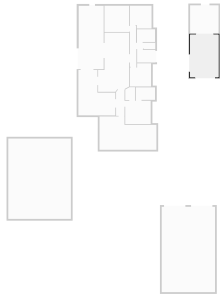

▼ **Garage**
Ground Floor

WIDTH: 8.80 m • LENGTH: 11.30 m
AREA: 99.44 m² • PERIMETER: 40.20 m

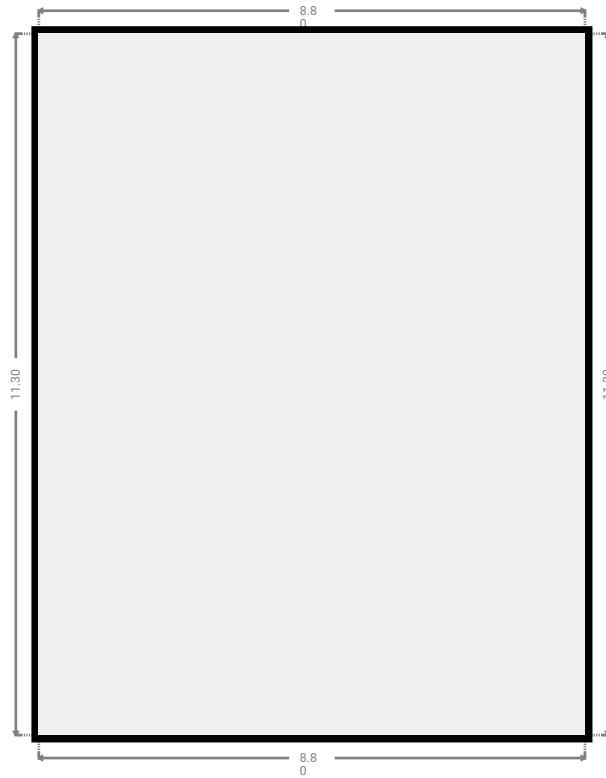
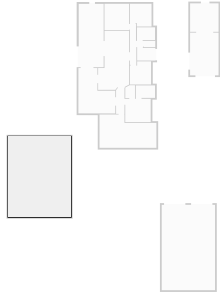

▼ **Other**
Ground Floor

WIDTH: 8.00 m • LENGTH: 4.68 m
AREA: 32.12 m² • PERIMETER: 25.35 m

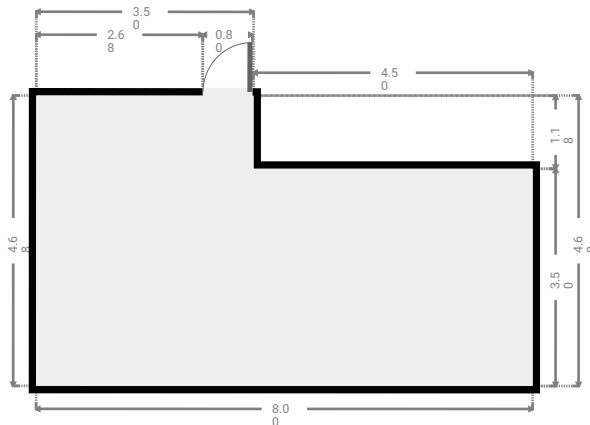
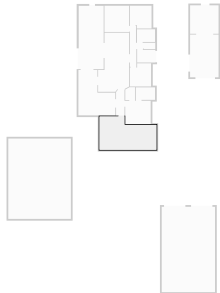

▼ Other
Ground Floor

WIDTH: 3.50 m • LENGTH: 8.90 m
AREA: 31.16 m² • PERIMETER: 24.80 m

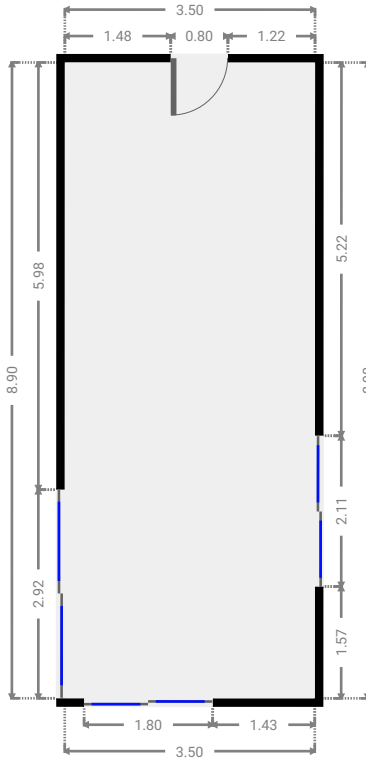
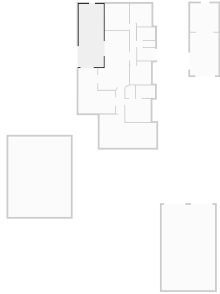

▼ Bedroom
Ground Floor

WIDTH: 3.04 m • LENGTH: 3.19 m
AREA: 9.24 m² • PERIMETER: 12.47 m

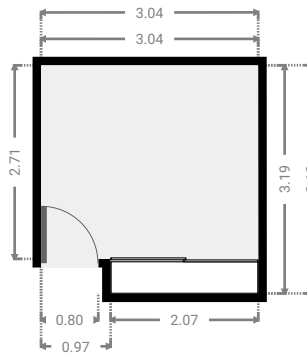
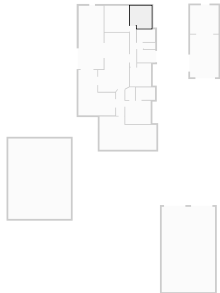

▼ **Master Bedroom**
Ground Floor

WIDTH: 3.45 m • LENGTH: 3.68 m
AREA: 12.70 m² • PERIMETER: 14.26 m

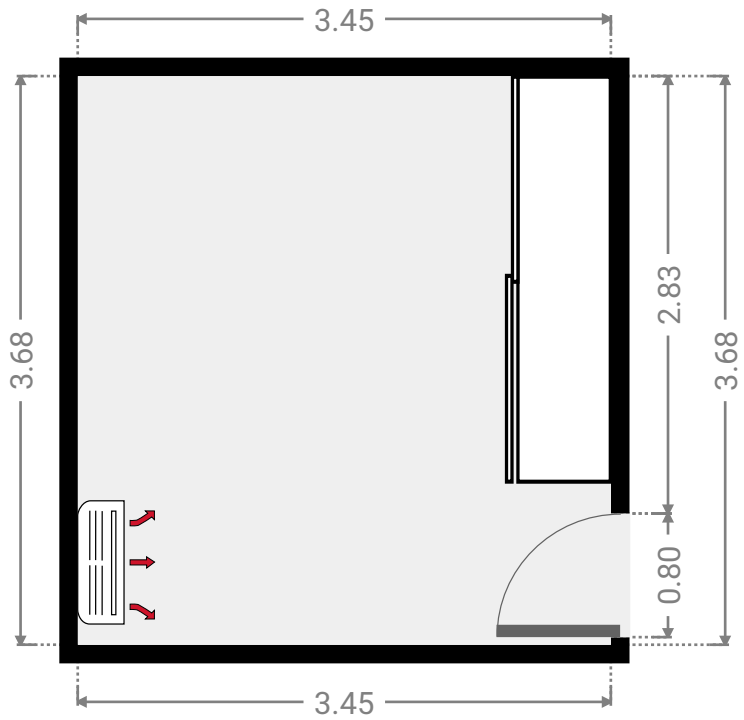
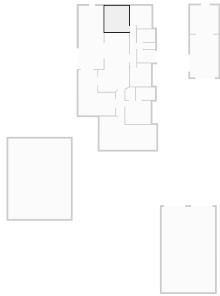

▼ **Bathroom**
Ground Floor

WIDTH: 2.54 m • LENGTH: 1.78 m
AREA: 4.52 m² • PERIMETER: 8.64 m

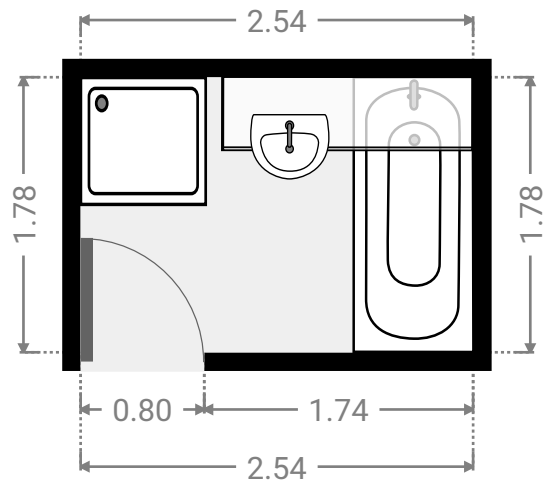
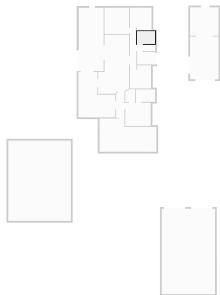

▼ Hall
Ground Floor

WIDTH: 1.19 m • LENGTH: 3.69 m
AREA: 4.29 m² • PERIMETER: 9.55 m

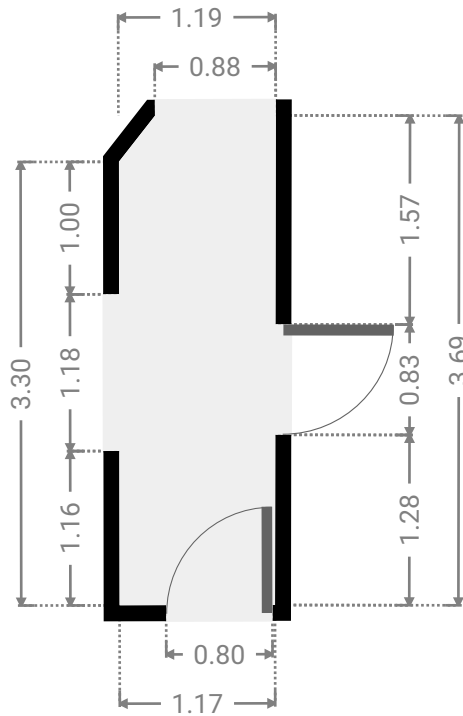
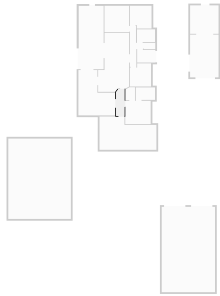

▼ Laundry Room
Ground Floor

WIDTH: 2.55 m • LENGTH: 1.77 m
AREA: 4.51 m² • PERIMETER: 8.64 m

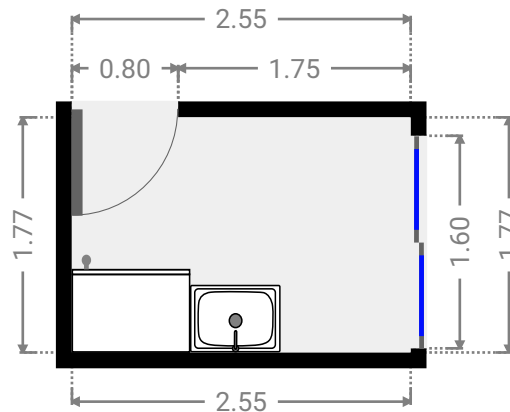
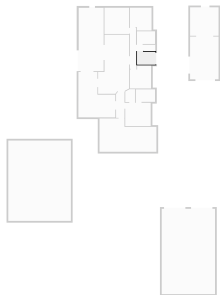

▼ Kitchen
Ground Floor

WIDTH: 4.35 m • LENGTH: 8.31 m
AREA: 30.57 m² • PERIMETER: 24.86 m

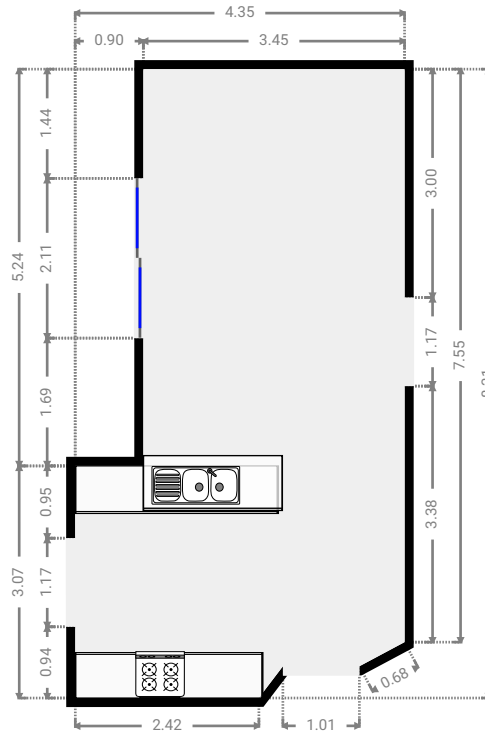
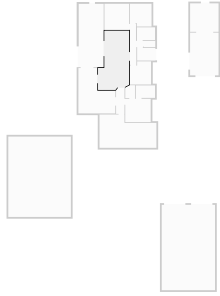

▼ Living Room
Ground Floor

WIDTH: 5.18 m • LENGTH: 6.39 m
AREA: 24.98 m² • PERIMETER: 23.11 m

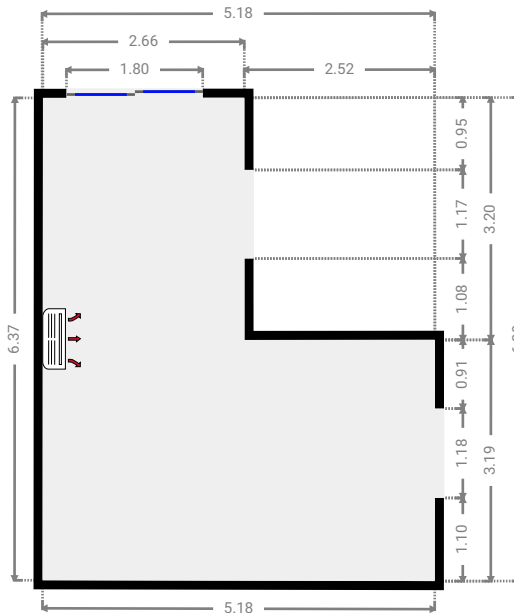
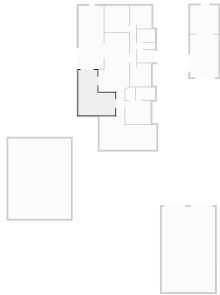

▼ **Closet**
Ground Floor

WIDTH: 1.36 m • LENGTH: 1.80 m
AREA: 2.35 m² • PERIMETER: 6.08 m

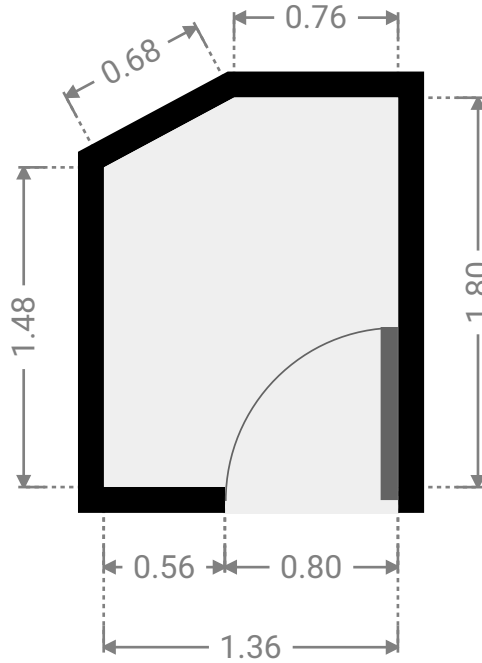
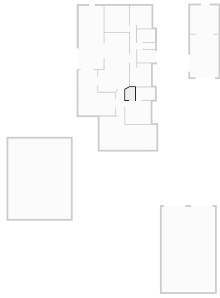

▼ **Bathroom**
Ground Floor

WIDTH: 2.70 m • LENGTH: 1.75 m
AREA: 4.73 m² • PERIMETER: 8.90 m

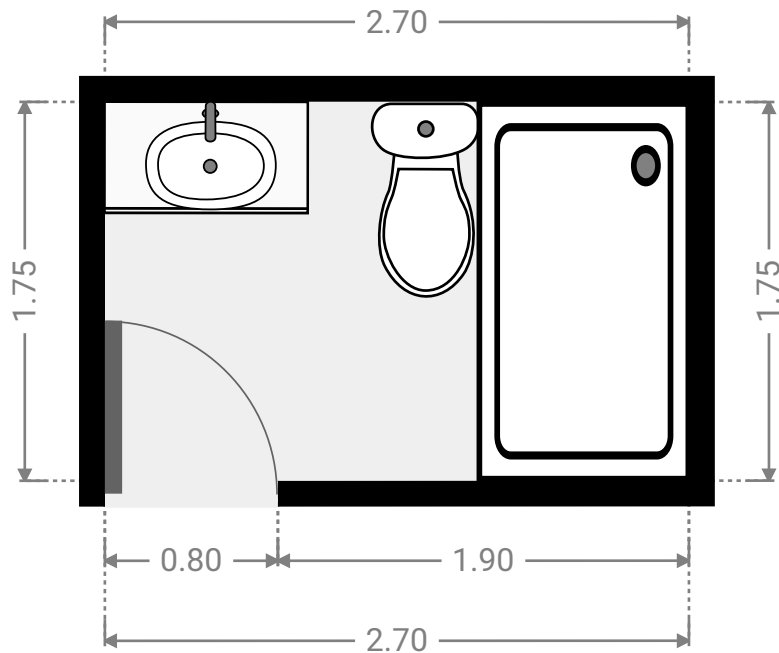

▼ Master Bedroom
Ground Floor

WIDTH: 3.57 m • LENGTH: 3.27 m
AREA: 11.67 m² • PERIMETER: 13.68 m

