

9 Warner Avenue

Created on
2017-11-30

Floors

1

FLOORS: 1

▼ Ground Floor

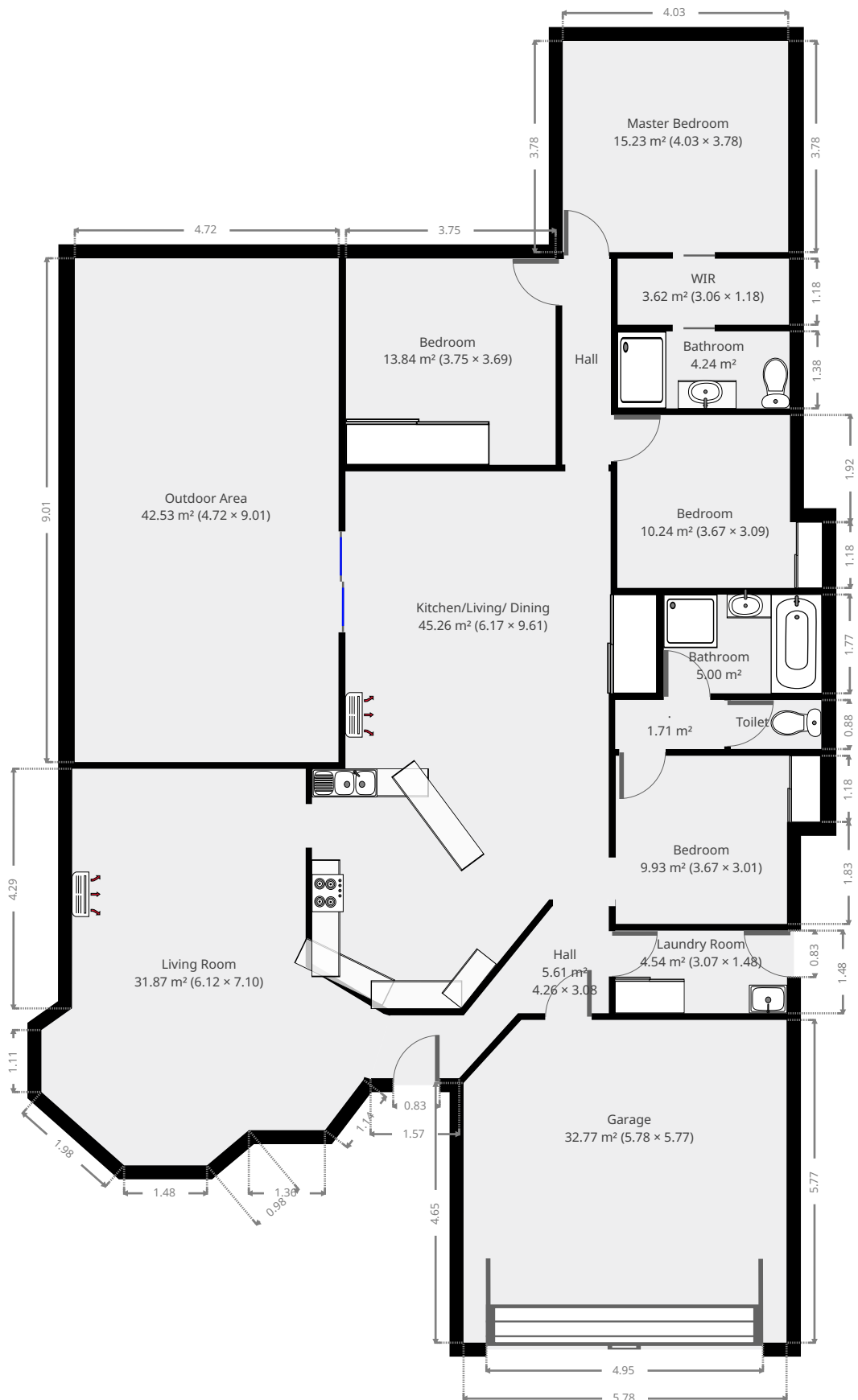

THIS FLOORPLAN IS PROVIDED WITHOUT WARRANTY OF ANY KIND. SENSOPIA DISCLAIMS ANY WARRANTY INCLUDING, WITHOUT LIMITATION, SATISFACTORY QUALITY OR ACCURACY OF DIMENSIONS.



FLOORS: 1

▼ Living Room Ground Floor

WIDTH: 6.12 m • **LENGTH:** 7.10 m
AREA: 31.87 m² • **PERIMETER:** 23.58 m

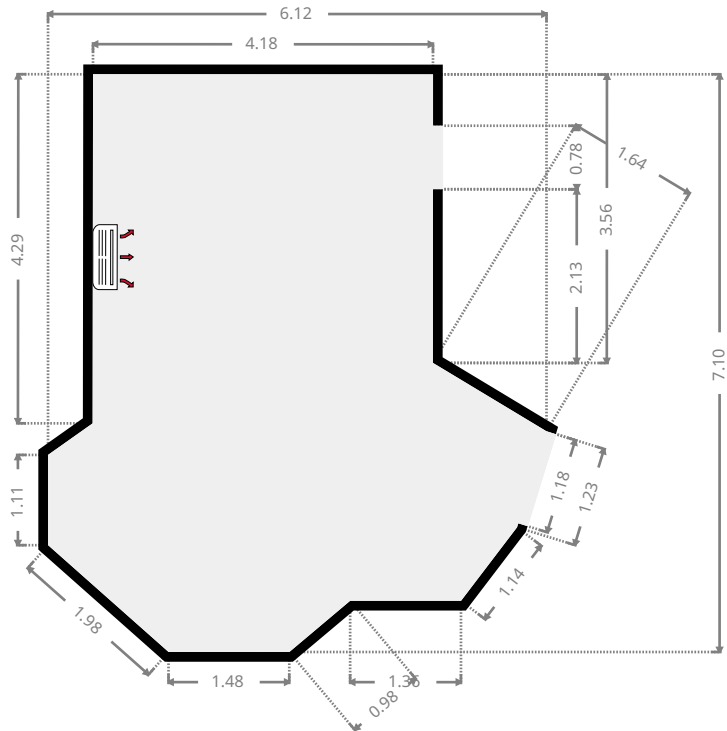
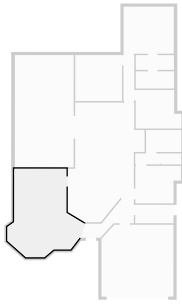

▼ Garage Ground Floor

WIDTH: 5.78 m • **LENGTH:** 5.77 m
AREA: 32.77 m² • **PERIMETER:** 22.47 m

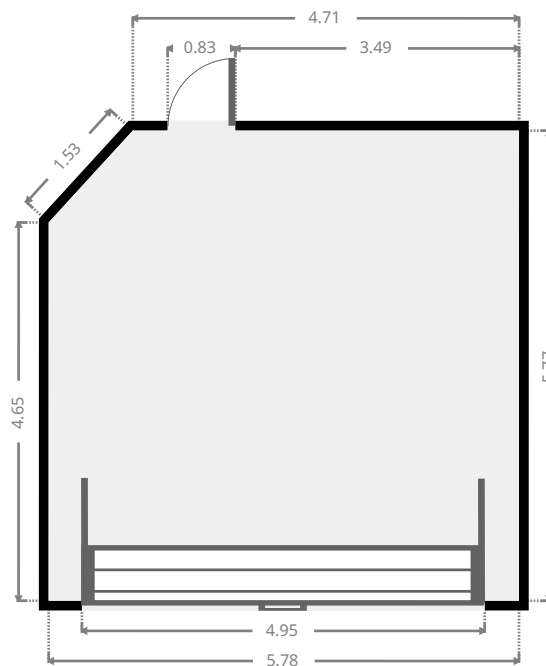
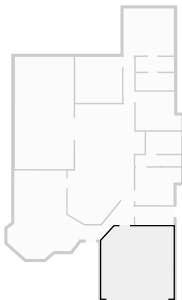

THIS FLOORPLAN IS PROVIDED WITHOUT WARRANTY OF ANY KIND. SENSOPIA DISCLAIMS ANY WARRANTY INCLUDING, WITHOUT LIMITATION, SATISFACTORY QUALITY OR ACCURACY OF DIMENSIONS.

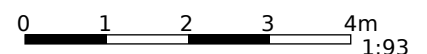

FLOORS: 1

▼ **Laundry Room**
Ground Floor

WIDTH: 3.07 m • LENGTH: 1.48 m
AREA: 4.54 m² • PERIMETER: 9.10 m

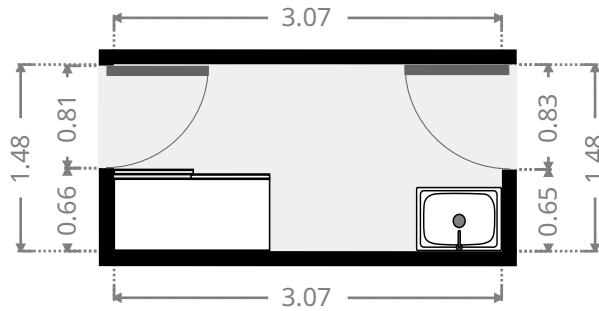
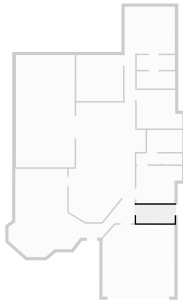

▼ **Hall**
Ground Floor

WIDTH: 4.26 m • LENGTH: 3.08 m
AREA: 5.61 m² • PERIMETER: 12.71 m

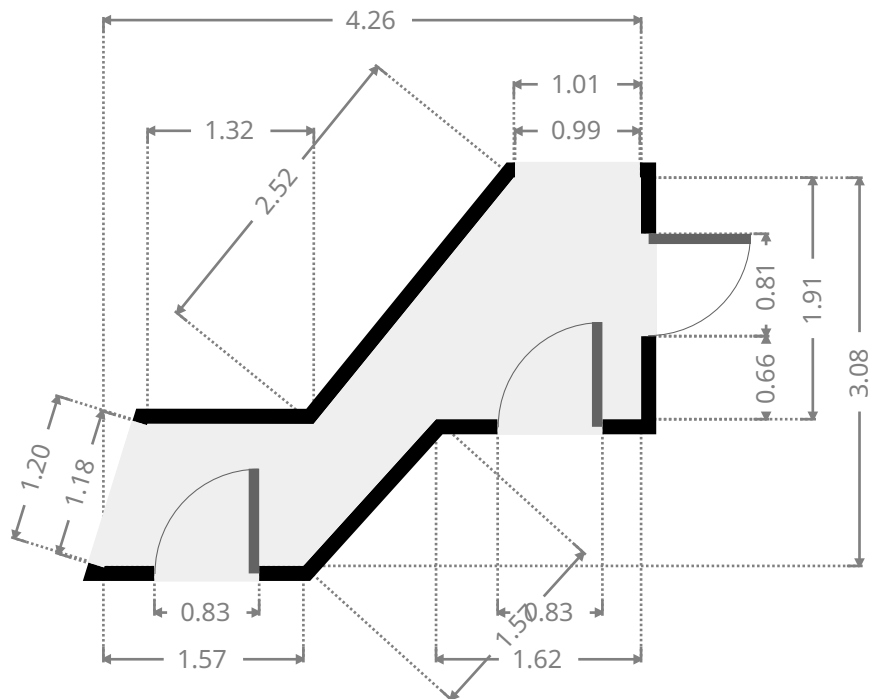
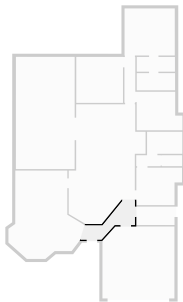

▼ Kitchen/Living/ Dining Ground Floor

WIDTH: 6.17 m • LENGTH: 9.61 m
AREA: 45.26 m² • PERIMETER: 29.96 m

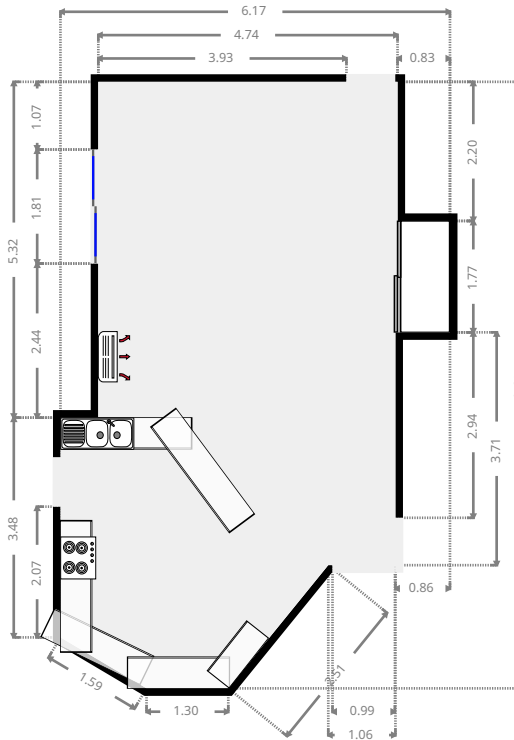
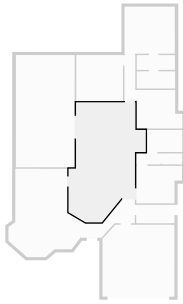

▼ Bedroom Ground Floor

WIDTH: 3.67 m • LENGTH: 3.01 m
AREA: 9.93 m² • PERIMETER: 13.35 m

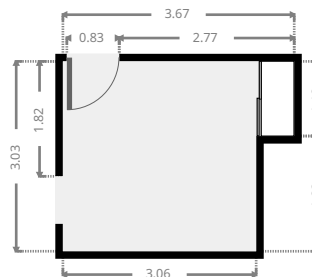
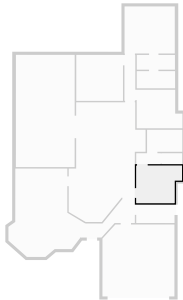

FLOORS: 1

▼ Ground Floor

WIDTH: 1.95 m • LENGTH: 0.88 m
AREA: 1.71 m² • PERIMETER: 5.66 m

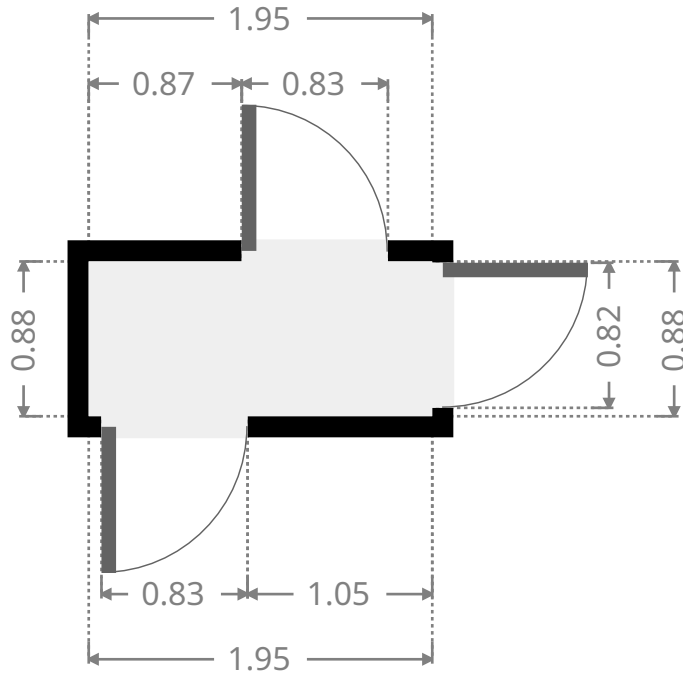
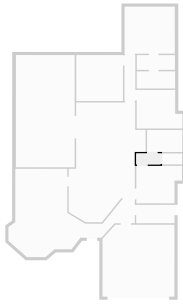

▼ Toilet Ground Floor

WIDTH: 1.62 m • LENGTH: 0.88 m
AREA: 1.42 m² • PERIMETER: 4.99 m

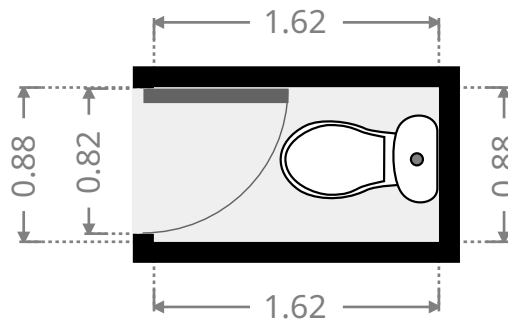
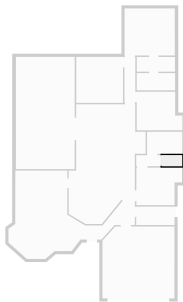

▼ Bathroom Ground Floor

WIDTH: 2.83 m • LENGTH: 1.77 m
AREA: 5.00 m² • PERIMETER: 9.19 m

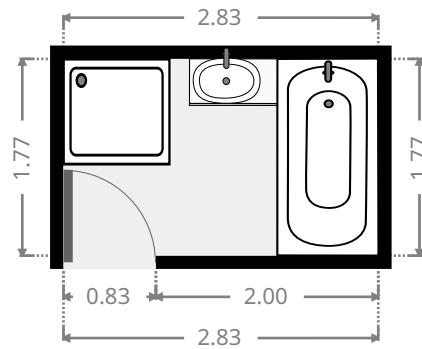
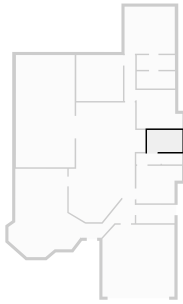

▼ Hall Ground Floor

WIDTH: 0.87 m • LENGTH: 3.68 m
AREA: 3.20 m² • PERIMETER: 9.09 m

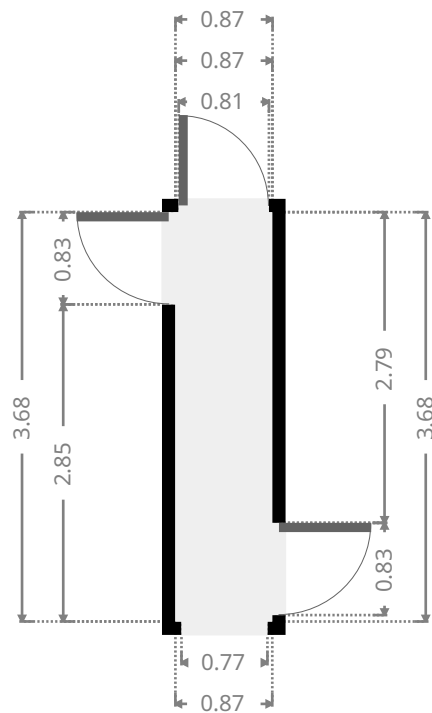

▼ **Bedroom**
Ground Floor

WIDTH: 3.67 m • LENGTH: 3.09 m
AREA: 10.24 m² • PERIMETER: 13.52 m

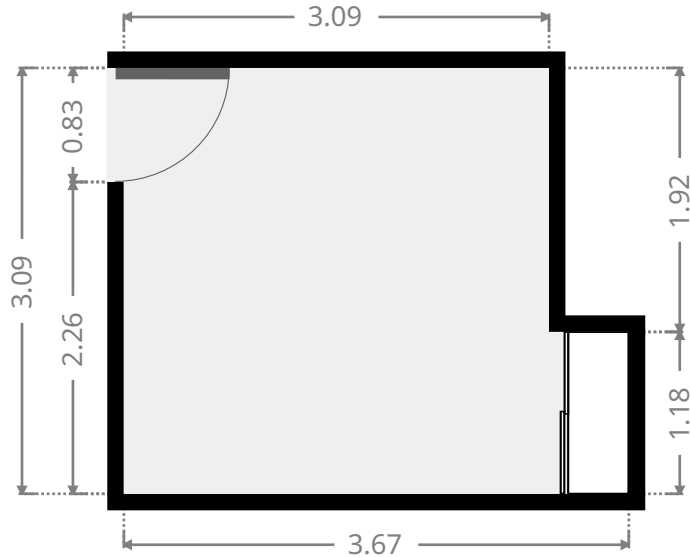
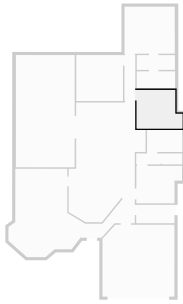

▼ **Master Bedroom**
Ground Floor

WIDTH: 4.03 m • LENGTH: 3.78 m
AREA: 15.23 m² • PERIMETER: 15.62 m

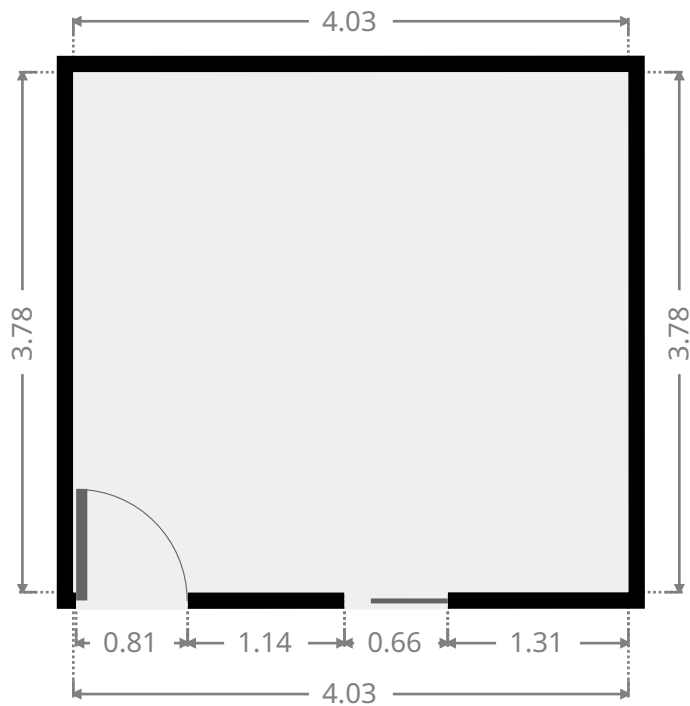
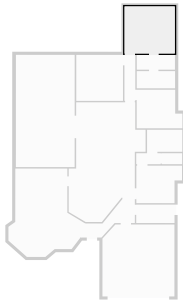

FLOORS: 1

▼ **WIR**
Ground Floor

WIDTH: 3.06 m • LENGTH: 1.18 m
AREA: 3.62 m² • PERIMETER: 8.49 m

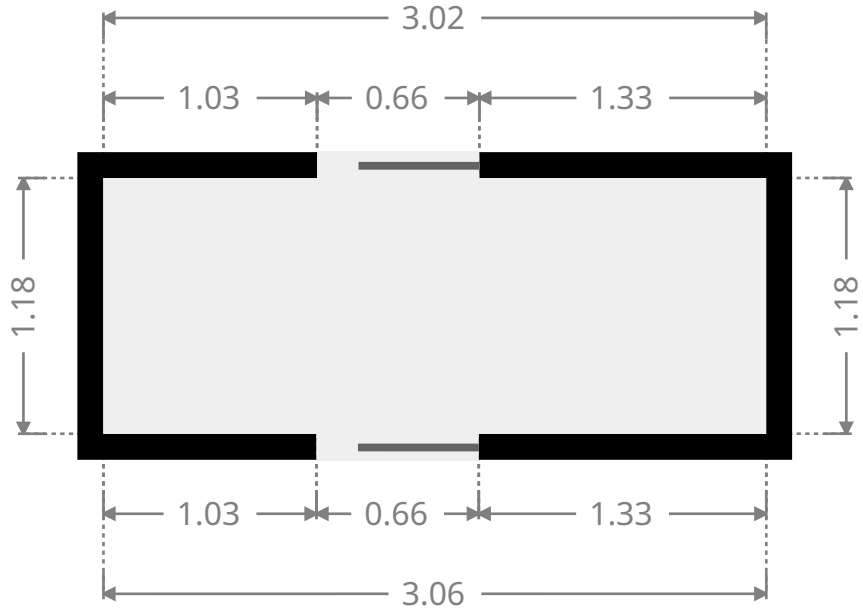
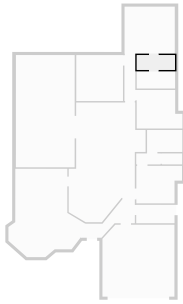

▼ **Bathroom**
Ground Floor

WIDTH: 3.08 m • LENGTH: 1.38 m
AREA: 4.24 m² • PERIMETER: 8.91 m

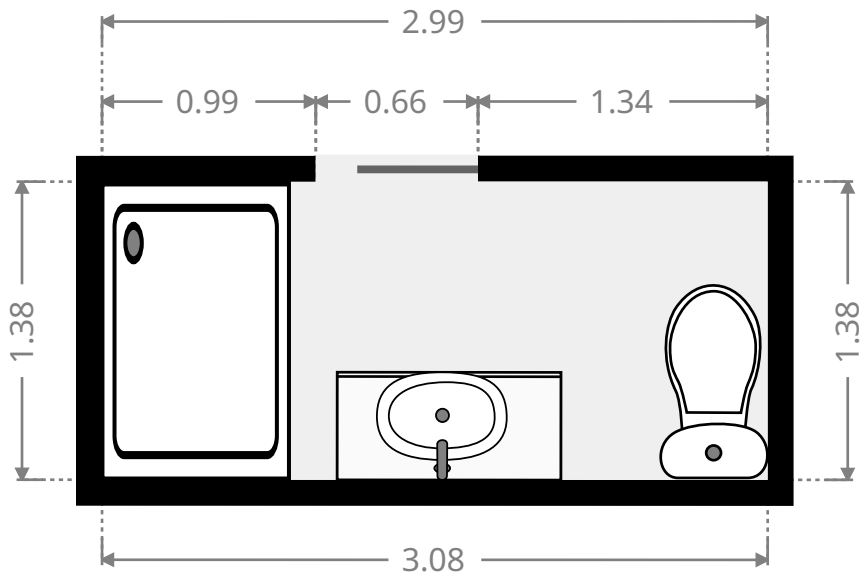
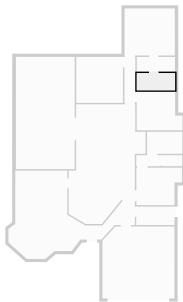

FLOORS: 1

▼ Bedroom Ground Floor

WIDTH: 3.75 m • LENGTH: 3.69 m
AREA: 13.84 m² • PERIMETER: 14.88 m

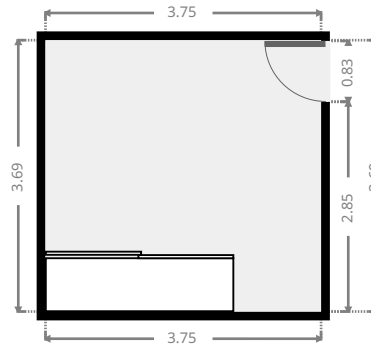
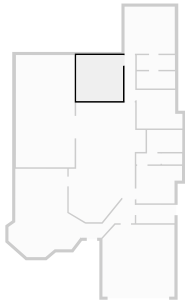

▼ Outdoor Area Ground Floor

WIDTH: 4.72 m • LENGTH: 9.01 m
AREA: 42.53 m² • PERIMETER: 27.46 m

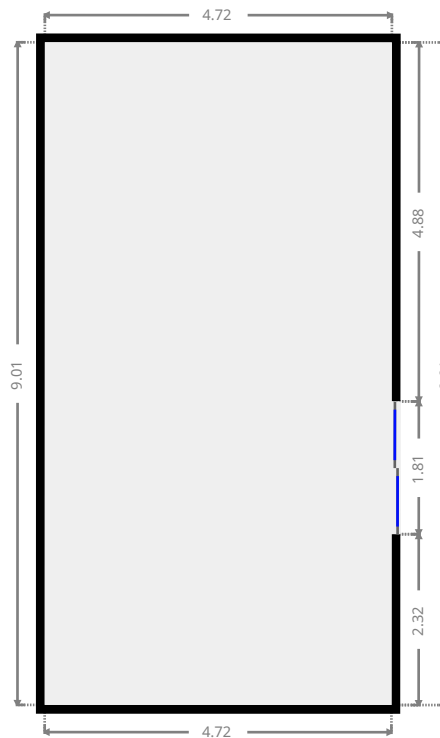
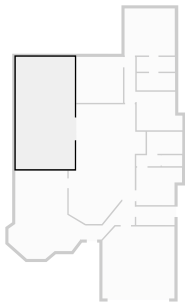

THIS FLOORPLAN IS PROVIDED WITHOUT WARRANTY OF ANY KIND. SENSOPIA DISCLAIMS ANY WARRANTY INCLUDING, WITHOUT LIMITATION, SATISFACTORY QUALITY OR ACCURACY OF DIMENSIONS.

