

9 Vanderspek Place

Ground Floor

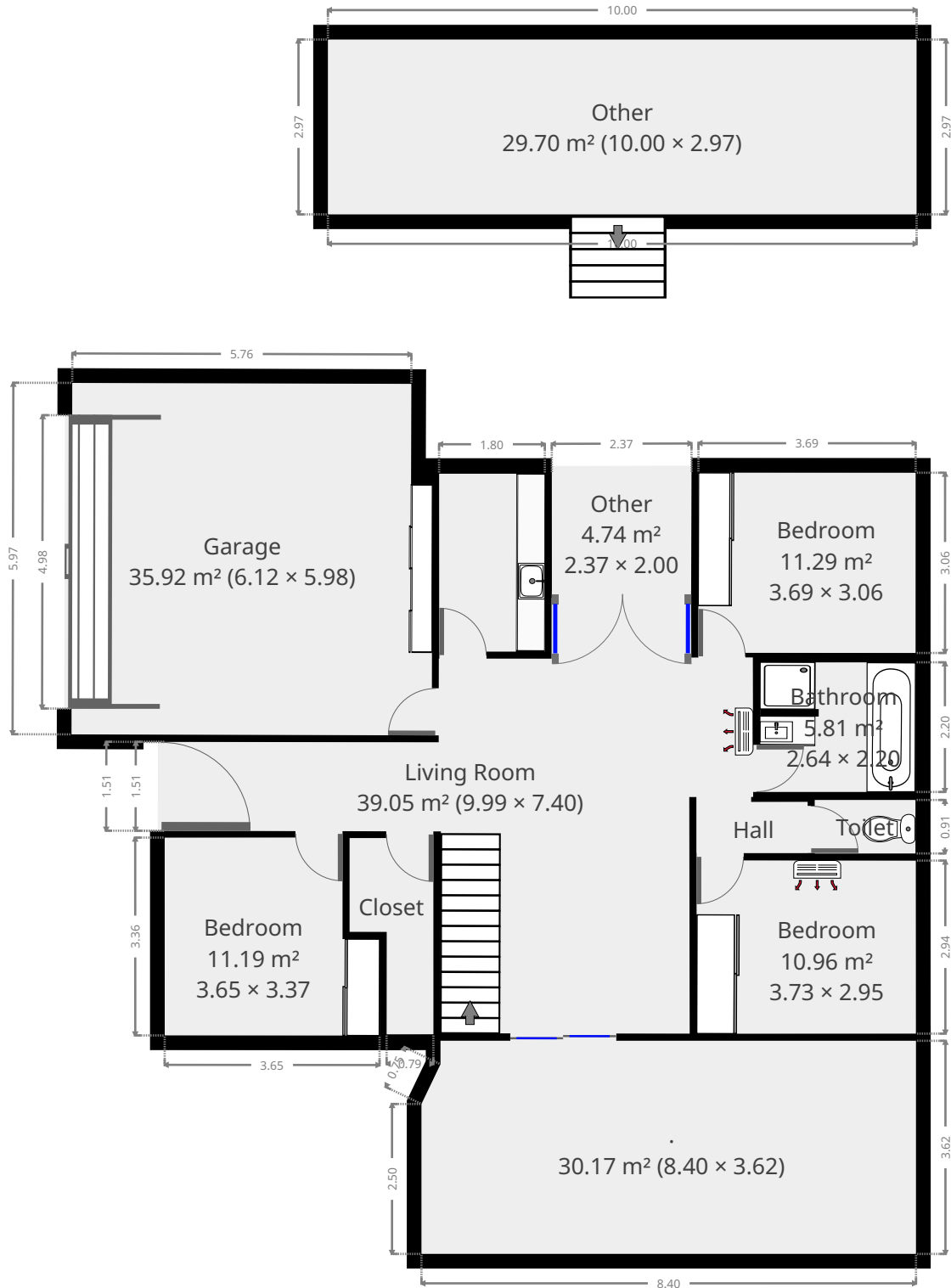

THIS FLOORPLAN IS PROVIDED WITHOUT WARRANTY OF ANY KIND. SENSOPIA DISCLAIMS ANY WARRANTY INCLUDING, WITHOUT LIMITATION, SATISFACTORY QUALITY OR ACCURACY OF DIMENSIONS.



9 Vanderspek Place

Living Room

Width: 7.40 m
 Length: 9.99 m
 Area: 39.05 m²
 Perimeter: 34.78 m

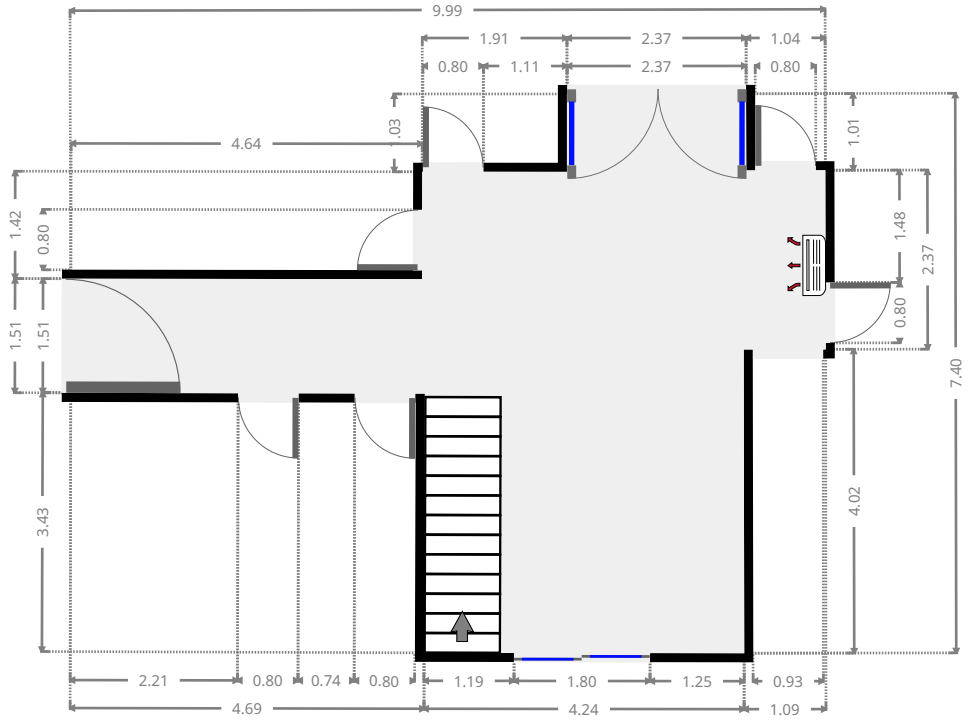
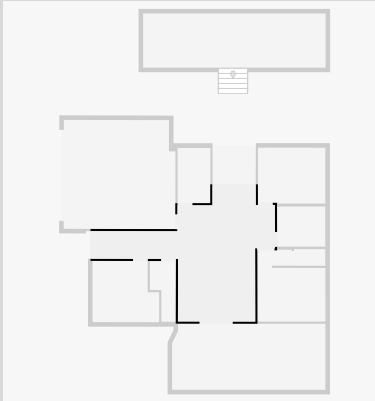

Bedroom

Width: 3.37 m
 Length: 3.65 m
 Area: 11.19 m²
 Perimeter: 14.03 m

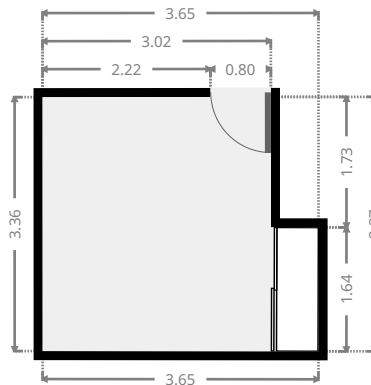
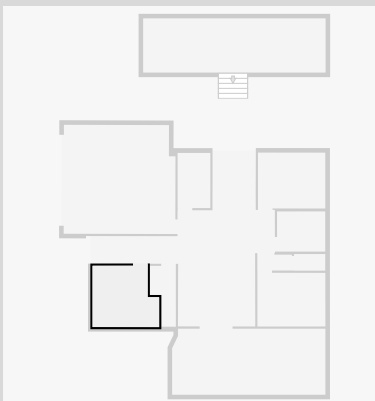

THIS FLOORPLAN IS PROVIDED WITHOUT WARRANTY OF ANY KIND. SENSOPIA DISCLAIMS ANY WARRANTY INCLUDING, WITHOUT LIMITATION, SATISFACTORY QUALITY OR ACCURACY OF DIMENSIONS.

9 Vanderspek Place

Closet

Width: 1.43 m
 Length: 3.34 m
 Area: 3.65 m²
 Perimeter: 9.52 m

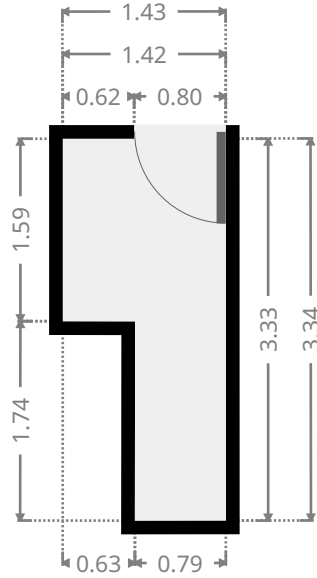
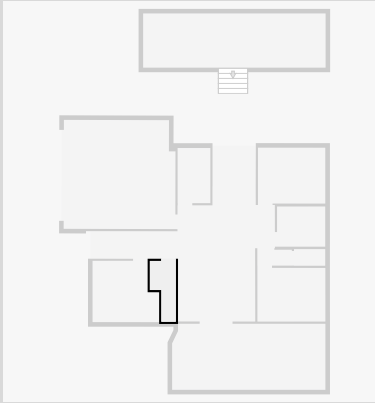

Garage

Width: 5.98 m
 Length: 6.12 m
 Area: 35.92 m²
 Perimeter: 24.18 m

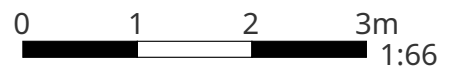
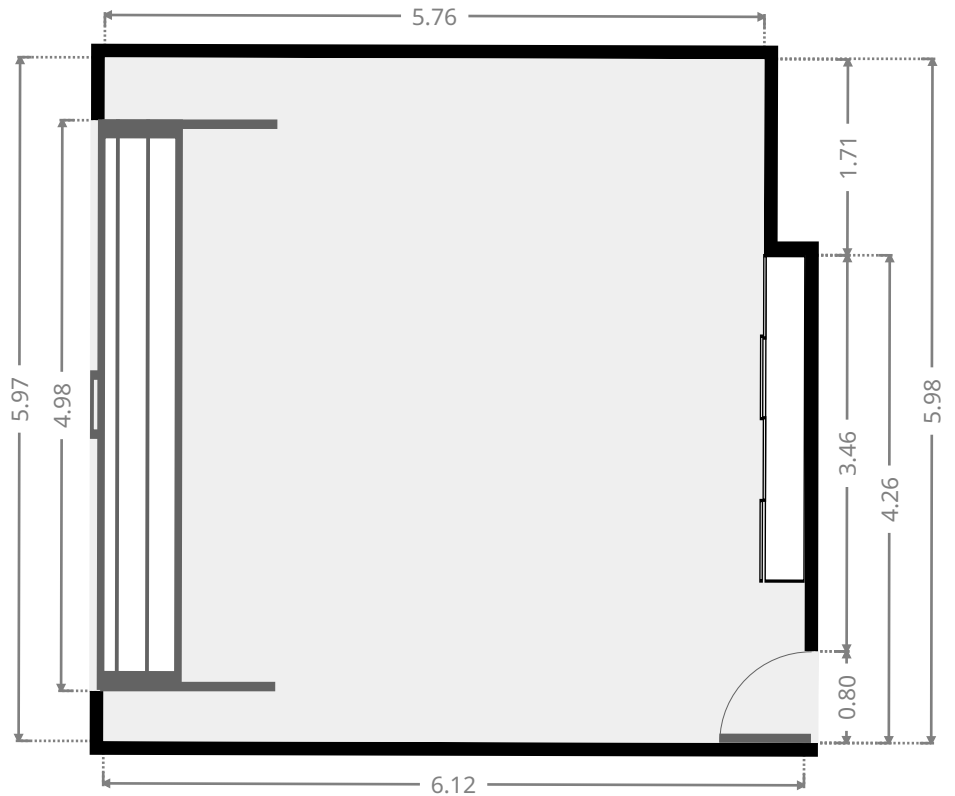
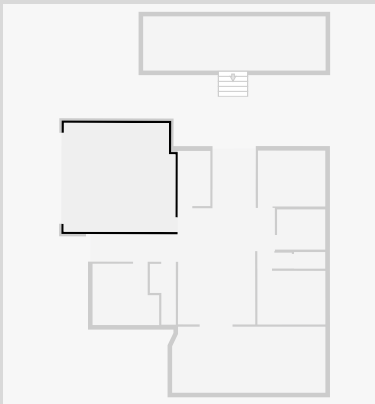

THIS FLOORPLAN IS PROVIDED WITHOUT WARRANTY OF ANY KIND. SENSOPIA DISCLAIMS ANY WARRANTY INCLUDING, WITHOUT LIMITATION, SATISFACTORY QUALITY OR ACCURACY OF DIMENSIONS.

9 Vanderspek Place

Laundry Room

Width: 1.80 m
 Length: 3.02 m
 Area: 5.43 m²
 Perimeter: 9.63 m

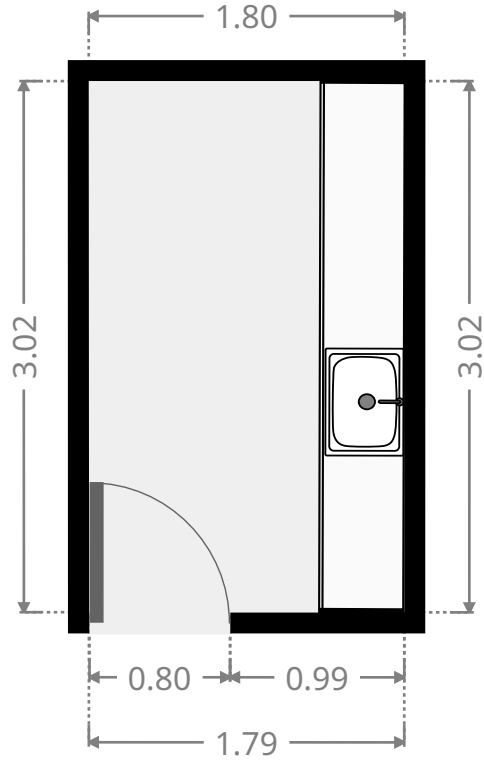

Bedroom

Width: 3.06 m
 Length: 3.69 m
 Area: 11.29 m²
 Perimeter: 13.50 m

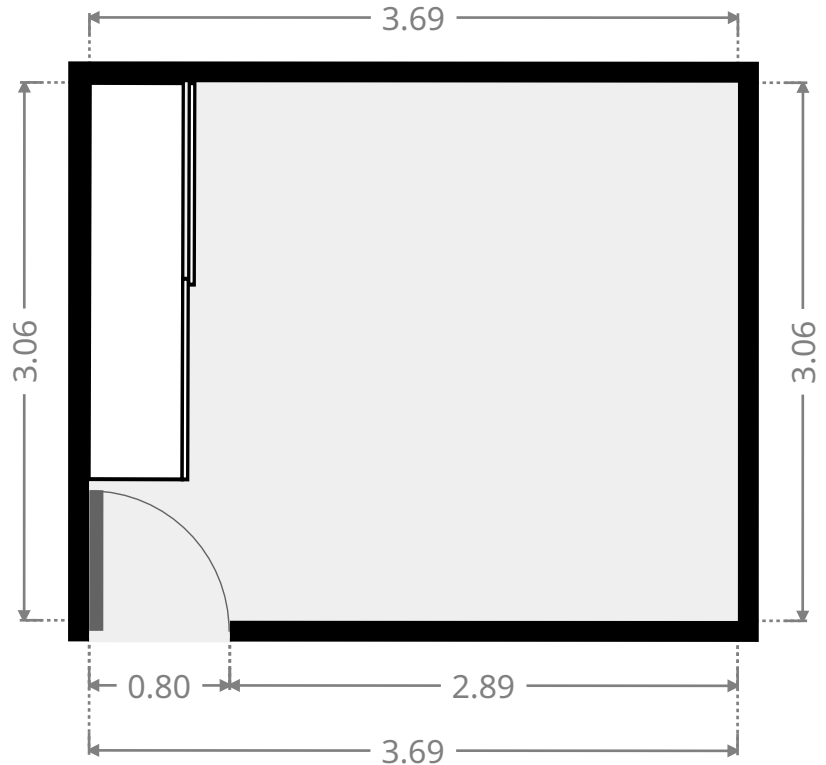
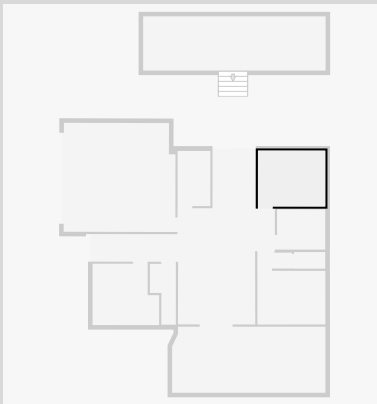

THIS FLOORPLAN IS PROVIDED WITHOUT WARRANTY OF ANY KIND. SENSOPIA DISCLAIMS ANY WARRANTY INCLUDING, WITHOUT LIMITATION, SATISFACTORY QUALITY OR ACCURACY OF DIMENSIONS.

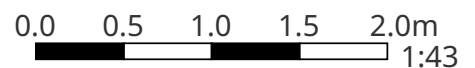

9 Vanderspek Place

Hall

Width: 0.87 m
 Length: 1.89 m
 Area: 1.65 m²
 Perimeter: 5.52 m

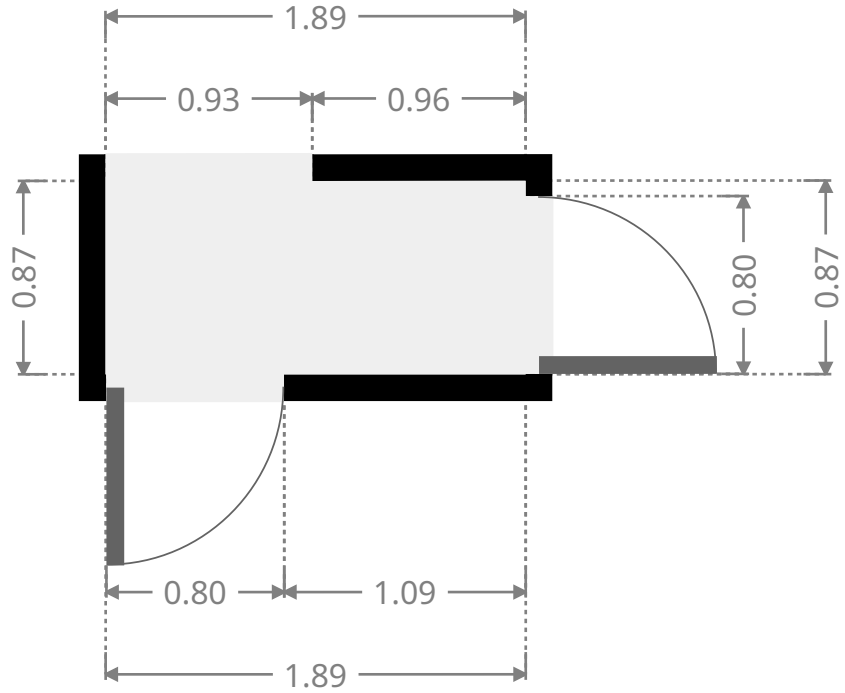
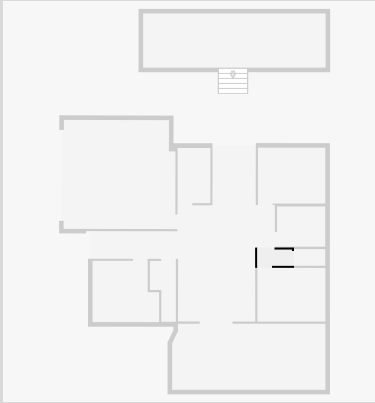

Bathroom

Width: 2.20 m
 Length: 2.64 m
 Area: 5.81 m²
 Perimeter: 9.68 m

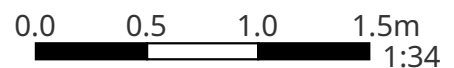
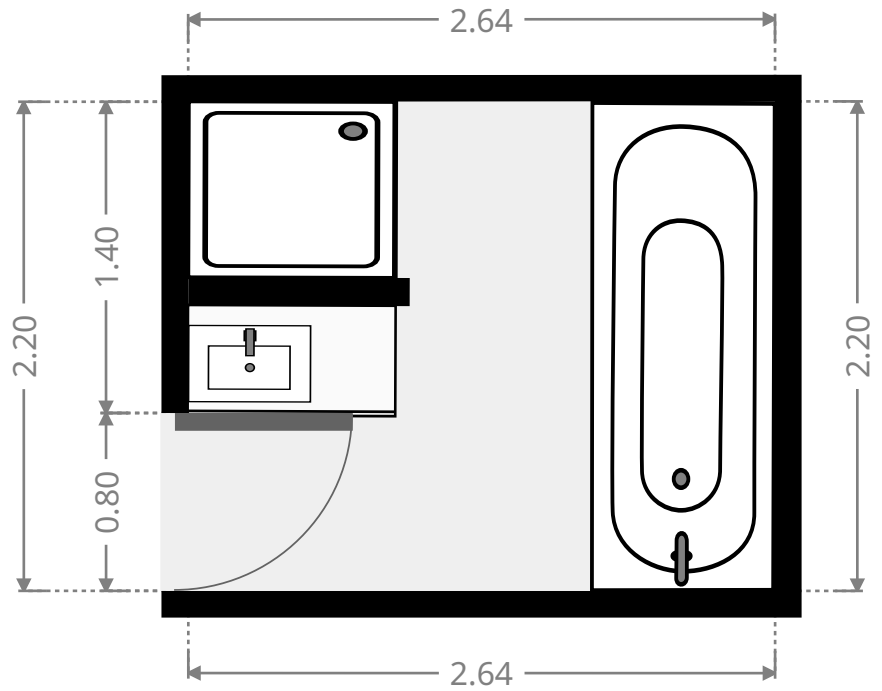
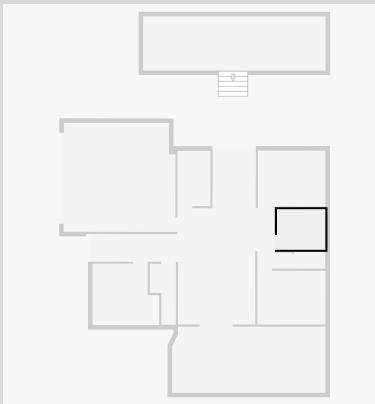

9 Vanderspek Place

Toilet / Half Bath

Width: 0.91 m
Length: 1.71 m
Area: 1.56 m²
Perimeter: 5.24 m

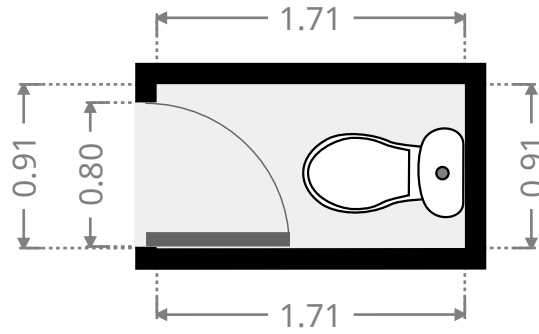
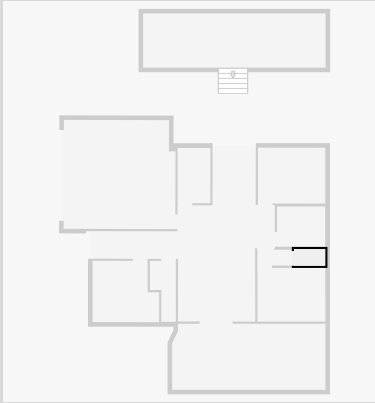

Bedroom

Width: 2.95 m
Length: 3.73 m
Area: 10.96 m²
Perimeter: 13.33 m

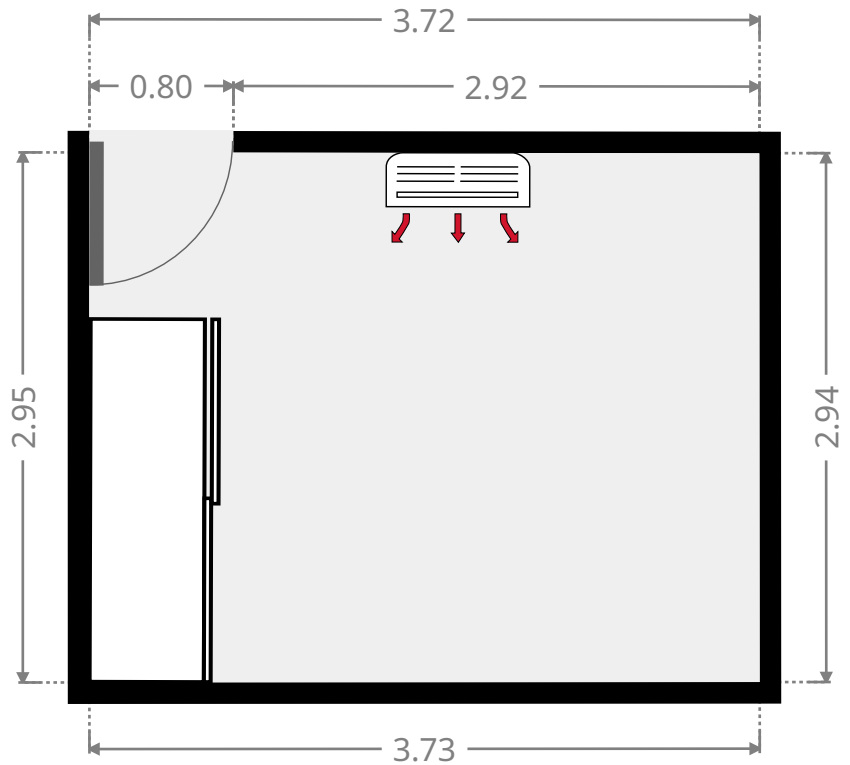
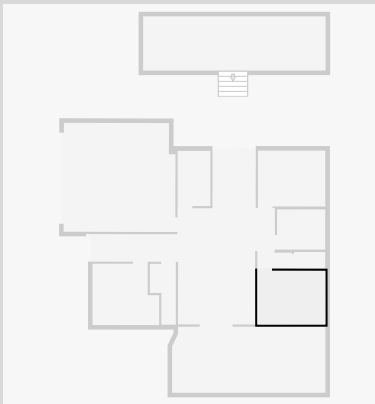

THIS FLOORPLAN IS PROVIDED WITHOUT WARRANTY OF ANY KIND. SENSOPIA DISCLAIMS ANY WARRANTY INCLUDING, WITHOUT LIMITATION, SATISFACTORY QUALITY OR ACCURACY OF DIMENSIONS.

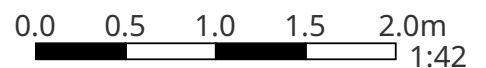

9 Vanderspek Place

Other

Width: 2.00 m
Length: 2.37 m
Area: 4.74 m²
Perimeter: 8.74 m

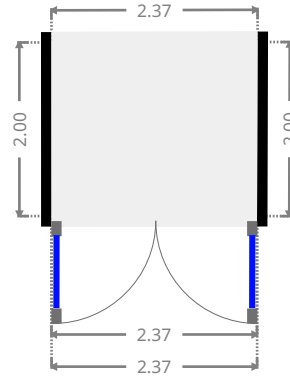

Other

Width: 2.97 m
Length: 10.00 m
Area: 29.70 m²
Perimeter: 25.94 m

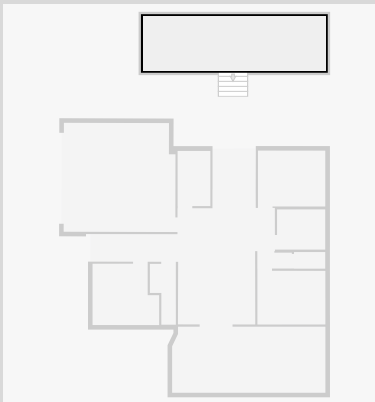

9 Vanderspek Place

•
Width: 3.62 m
Length: 8.40 m
Area: 30.17 m²
Perimeter: 23.79 m

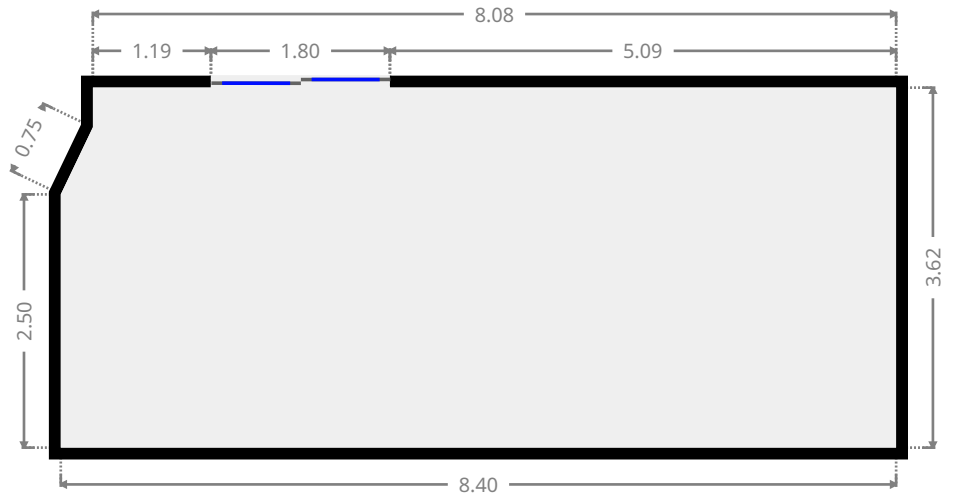
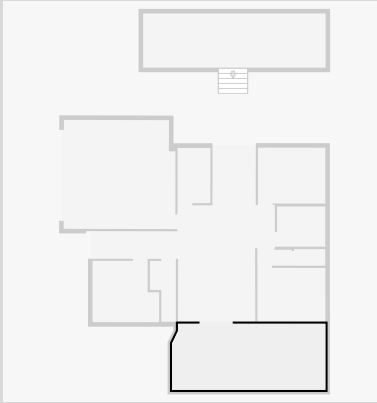

9 Vanderspek Place

1st Floor



THIS FLOORPLAN IS PROVIDED WITHOUT WARRANTY OF ANY KIND. SENSOPIA DISCLAIMS ANY WARRANTY INCLUDING, WITHOUT LIMITATION, SATISFACTORY QUALITY OR ACCURACY OF DIMENSIONS.



9 Vanderspek Place

Living Room

Width: 6.73 m
 Length: 10.62 m
 Area: 52.22 m²
 Perimeter: 35.86 m

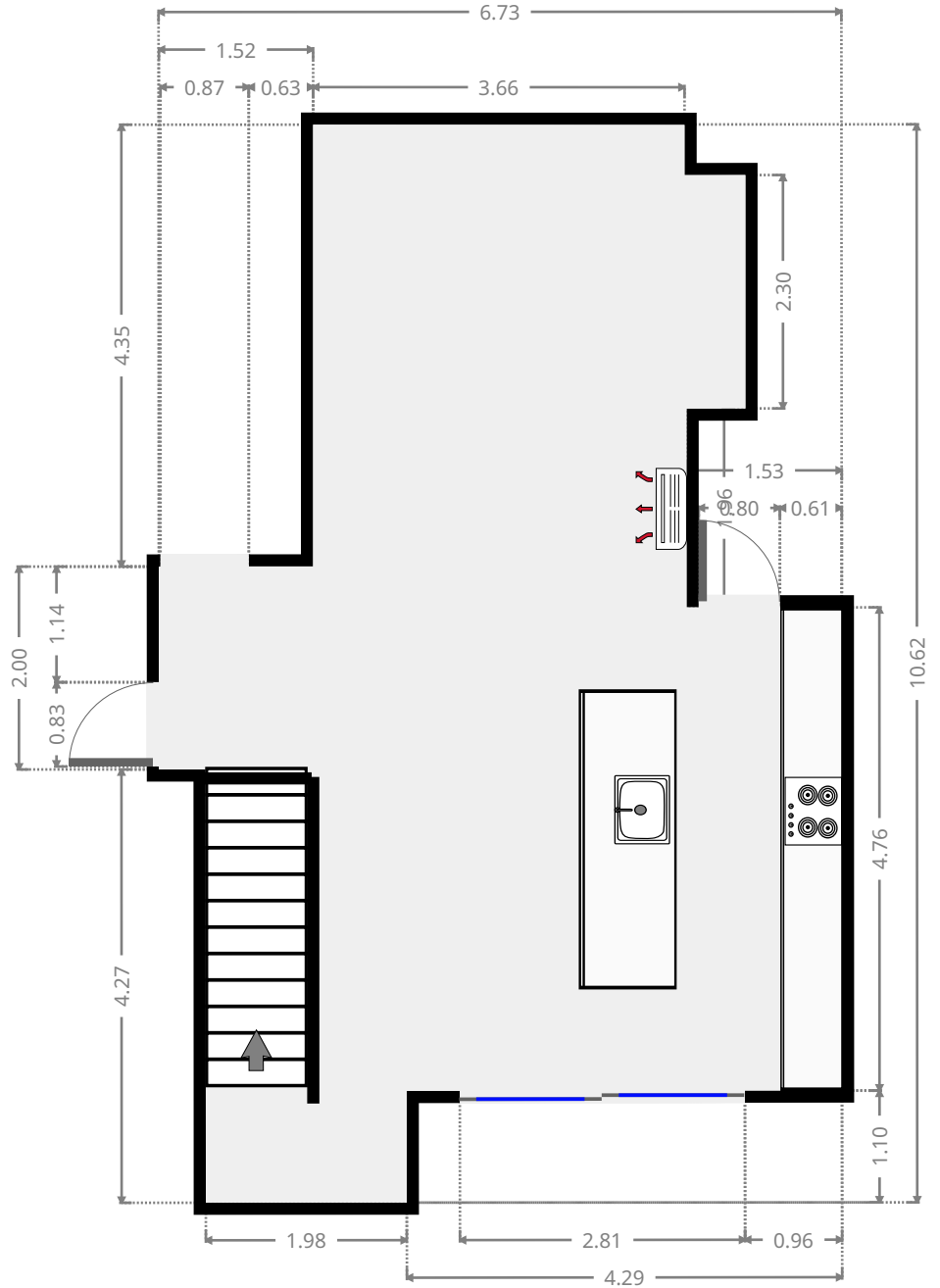
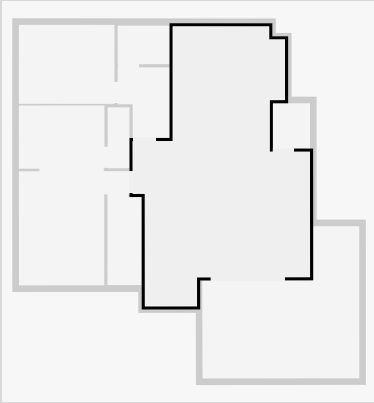

THIS FLOORPLAN IS PROVIDED WITHOUT WARRANTY OF ANY KIND. SENSOPIA DISCLAIMS ANY WARRANTY INCLUDING, WITHOUT LIMITATION, SATISFACTORY QUALITY OR ACCURACY OF DIMENSIONS.

9 Vanderspek Place

Closet

Width: 1.41 m
 Length: 1.72 m
 Area: 2.43 m²
 Perimeter: 6.26 m

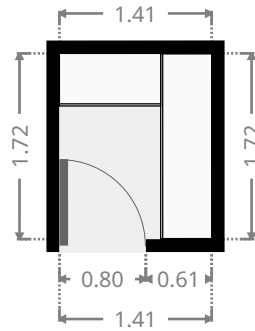
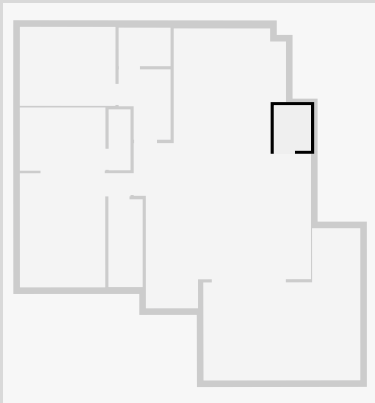

Deck

Width: 5.78 m
 Length: 5.96 m
 Area: 25.90 m²
 Perimeter: 23.46 m

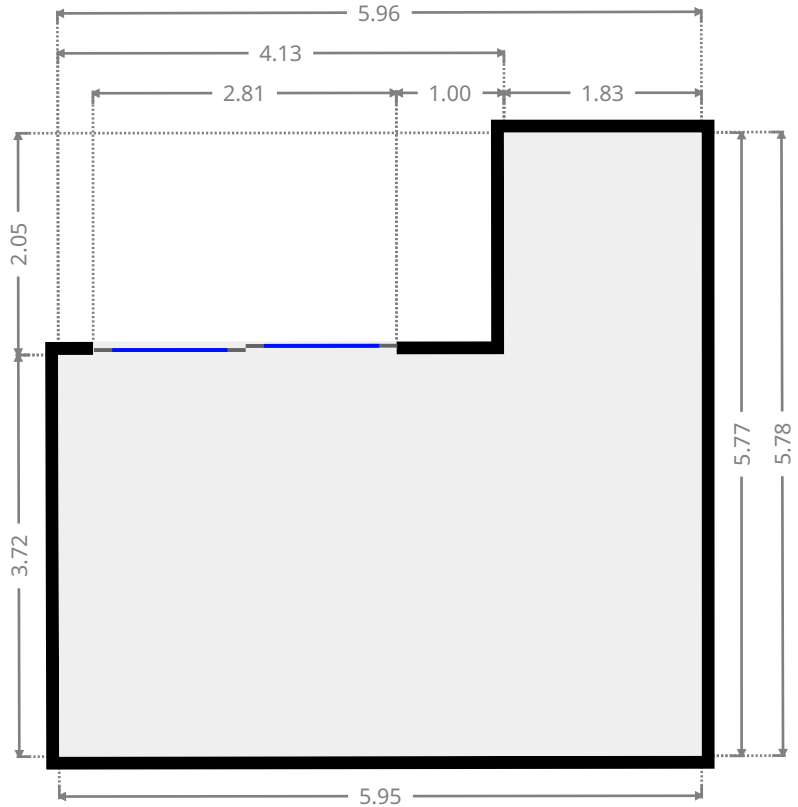
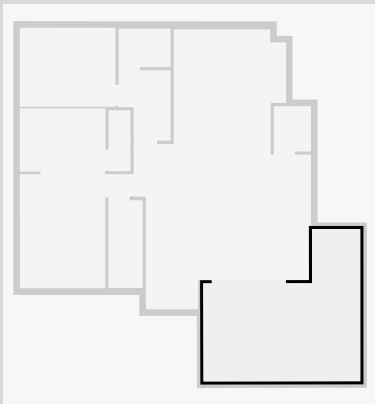

THIS FLOORPLAN IS PROVIDED WITHOUT WARRANTY OF ANY KIND. SENSOPIA DISCLAIMS ANY WARRANTY INCLUDING, WITHOUT LIMITATION, SATISFACTORY QUALITY OR ACCURACY OF DIMENSIONS.

9 Vanderspek Place

Master Bedroom

Width: 4.20 m
 Length: 4.33 m
 Area: 14.88 m²
 Perimeter: 17.06 m

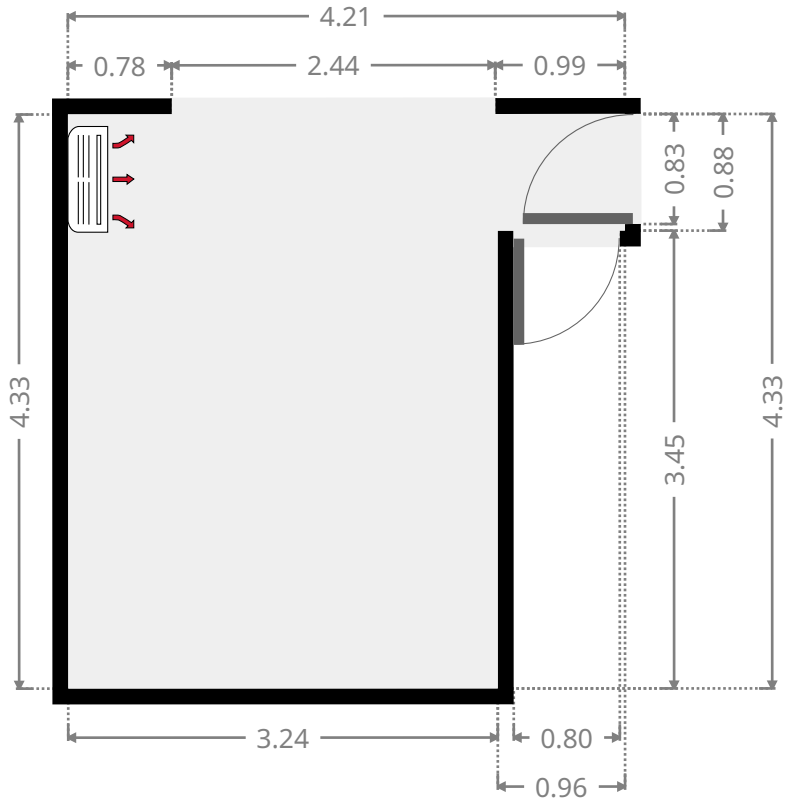
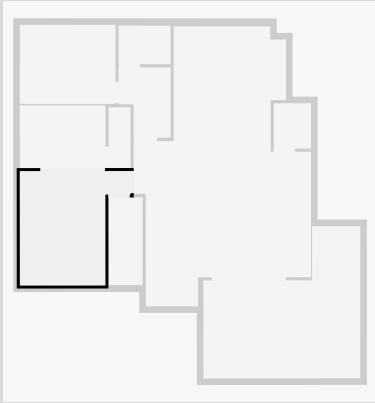

Bathroom

Width: 2.40 m
 Length: 3.25 m
 Area: 7.80 m²
 Perimeter: 11.30 m

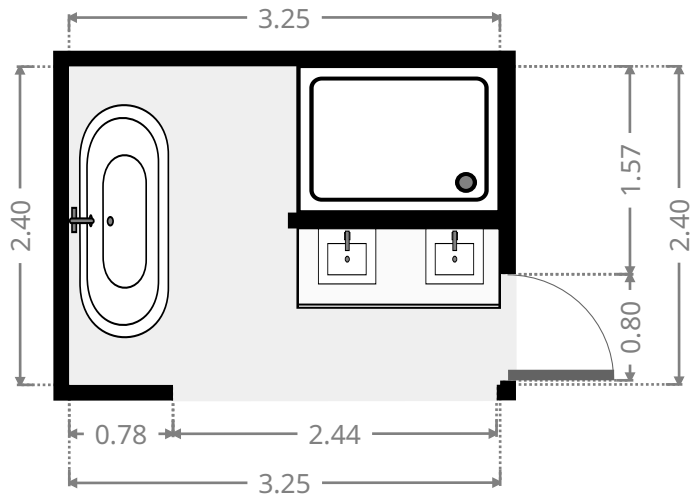
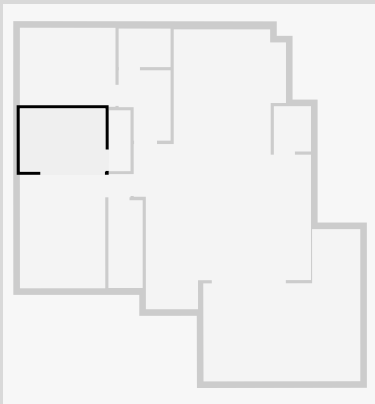

THIS FLOORPLAN IS PROVIDED WITHOUT WARRANTY OF ANY KIND. SENSOPIA DISCLAIMS ANY WARRANTY INCLUDING, WITHOUT LIMITATION, SATISFACTORY QUALITY OR ACCURACY OF DIMENSIONS.

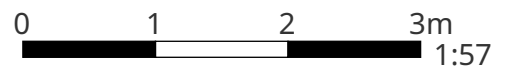

9 Vanderspek Place

Toilet / Half Bath

Width: 0.83 m
 Length: 2.31 m
 Area: 1.92 m²
 Perimeter: 6.28 m

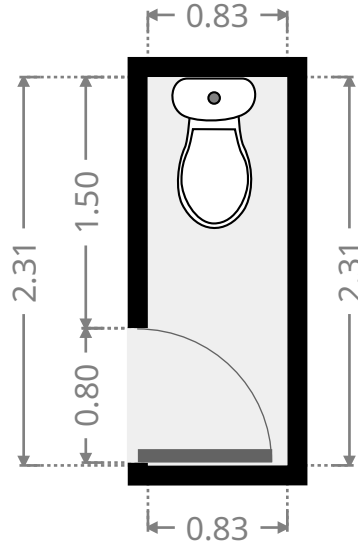
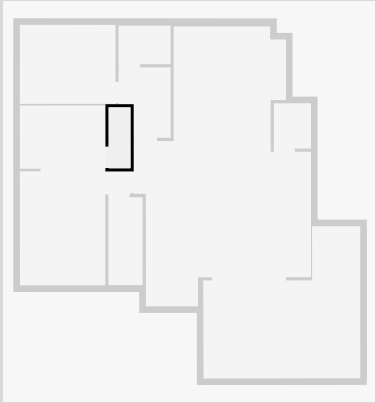

Width: 1.30 m
 Length: 3.33 m
 Area: 4.33 m²
 Perimeter: 9.26 m

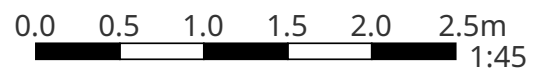
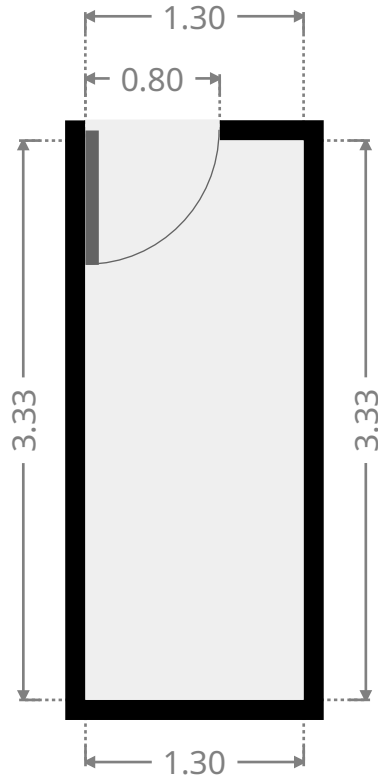
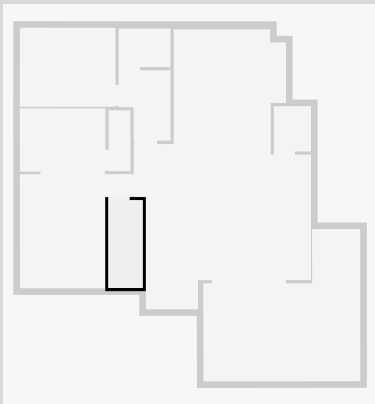

THIS FLOORPLAN IS PROVIDED WITHOUT WARRANTY OF ANY KIND. SENSOPIA DISCLAIMS ANY WARRANTY INCLUDING, WITHOUT LIMITATION, SATISFACTORY QUALITY OR ACCURACY OF DIMENSIONS.

9 Vanderspek Place

Hallway

Width: 1.97 m
 Length: 2.67 m
 Area: 4.54 m²
 Perimeter: 9.28 m

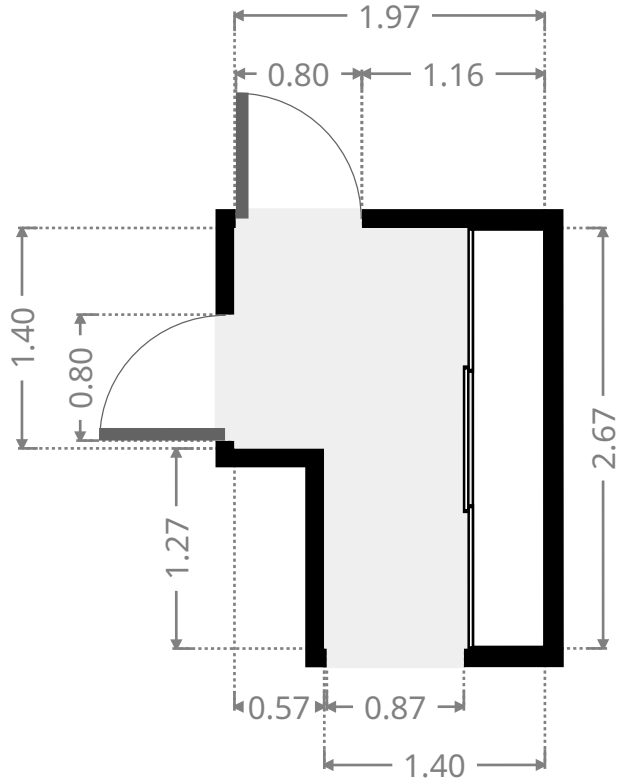
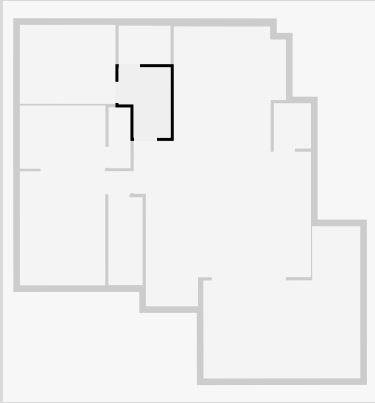

Toilet / Half Bath

Width: 1.47 m
 Length: 1.97 m
 Area: 2.88 m²
 Perimeter: 6.87 m

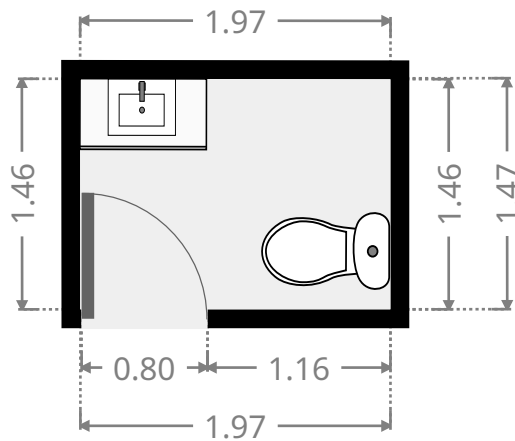
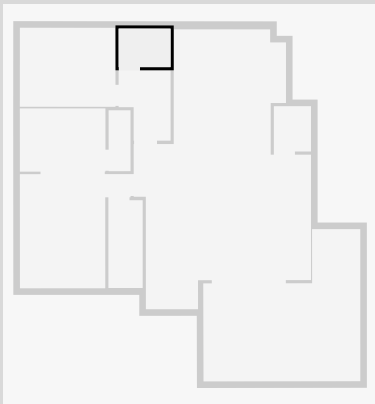

9 Vanderspek Place

Bedroom

Width: 3.00 m
Length: 3.63 m
Area: 10.89 m²
Perimeter: 13.26 m

