

Ground Floor

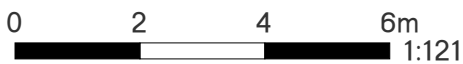
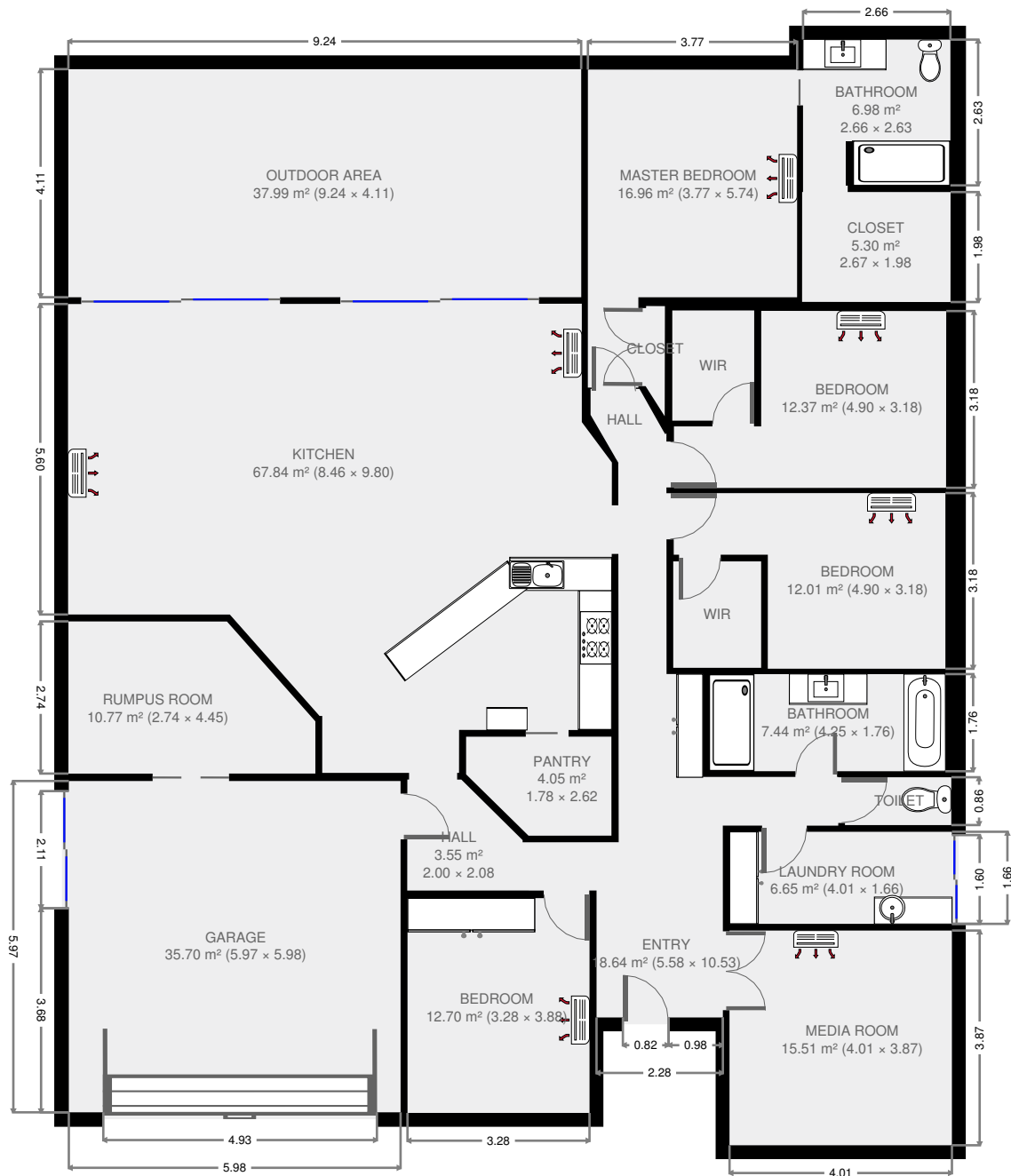

THIS FLOORPLAN IS PROVIDED WITHOUT WARRANTY OF ANY KIND. SENSOPIA DISCLAIMS ANY WARRANTY INCLUDING, WITHOUT LIMITATION, SATISFACTORY QUALITY OR ACCURACY OF DIMENSIONS.

9 Skyline Drive

WIR

Width: 1.48 m
Length: 1.98 m
Area: 2.93 m²
Perimeter: 6.92 m

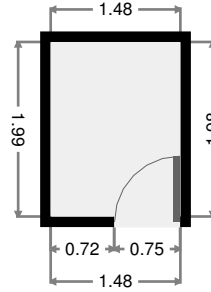
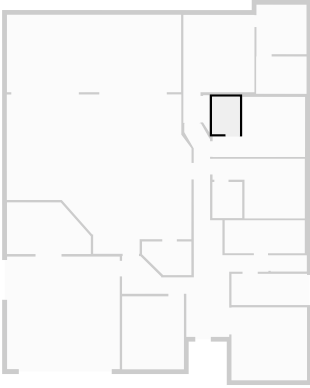

Outdoor Area

Width: 4.11 m
Length: 9.24 m
Area: 37.99 m²
Perimeter: 26.71 m

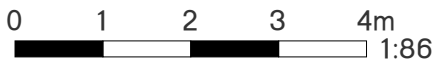
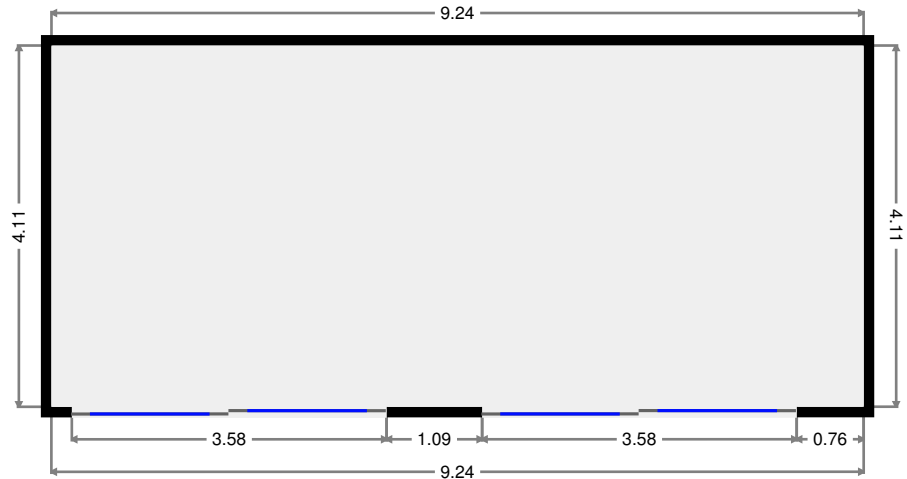
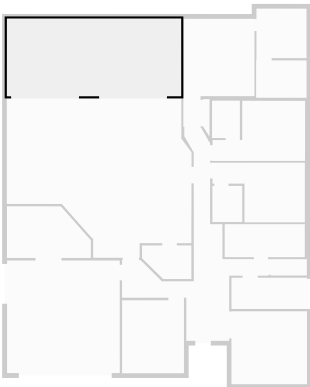

THIS FLOORPLAN IS PROVIDED WITHOUT WARRANTY OF ANY KIND. SENSOPIA DISCLAIMS ANY WARRANTY INCLUDING, WITHOUT LIMITATION, SATISFACTORY QUALITY OR ACCURACY OF DIMENSIONS.

Rumpus Room

Width: 2.74 m
 Length: 4.45 m
 Area: 10.77 m²
 Perimeter: 13.39 m

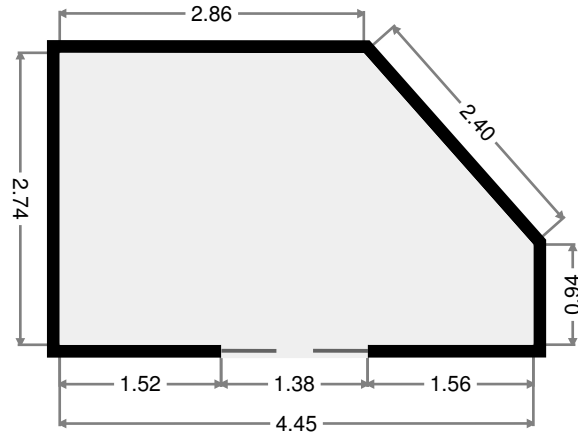
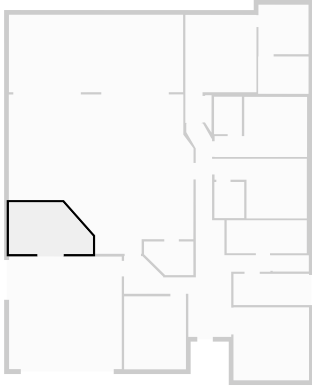

Garage

Width: 5.97 m
 Length: 5.98 m
 Area: 35.70 m²
 Perimeter: 23.90 m

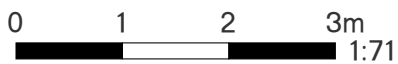
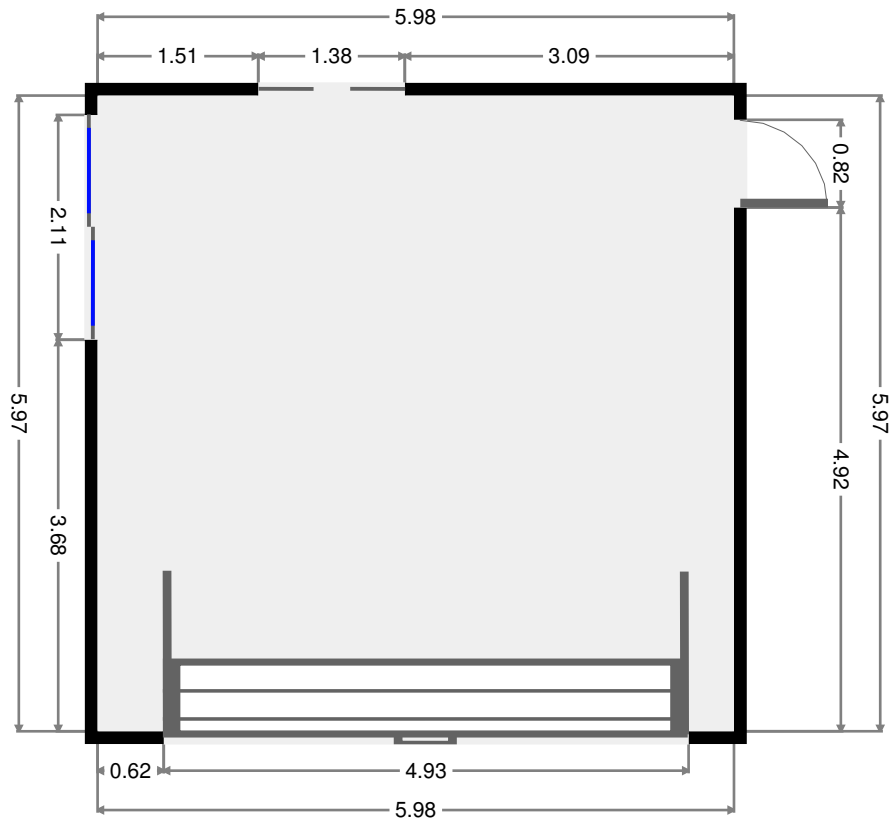
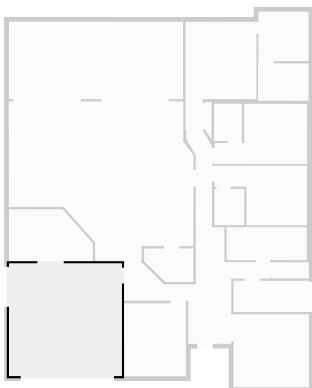

THIS FLOORPLAN IS PROVIDED WITHOUT WARRANTY OF ANY KIND. SENSOPIA DISCLAIMS ANY WARRANTY INCLUDING, WITHOUT LIMITATION, SATISFACTORY QUALITY OR ACCURACY OF DIMENSIONS.

Hall

Width: 2.00 m
 Length: 2.08 m
 Area: 3.55 m²
 Perimeter: 7.51 m

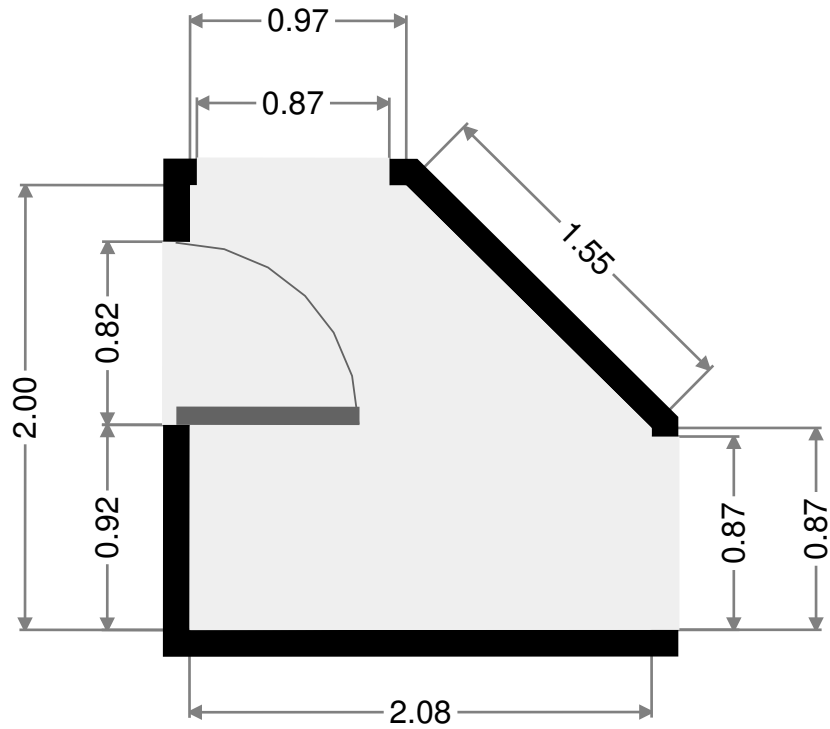
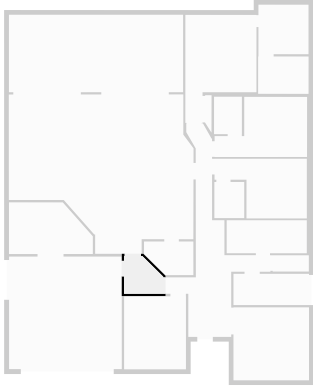

Pantry

Width: 1.78 m
 Length: 2.62 m
 Area: 4.05 m²
 Perimeter: 8.15 m

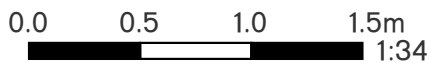
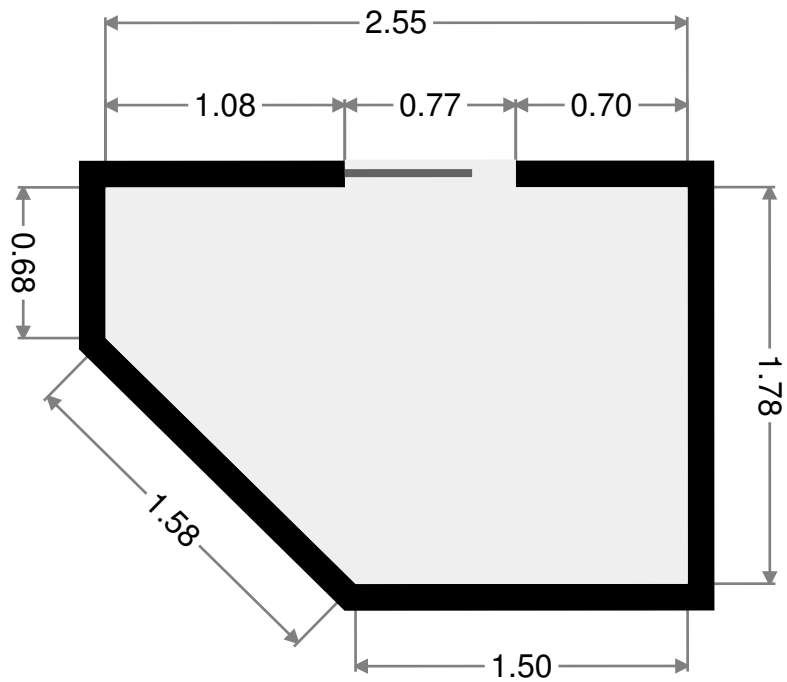
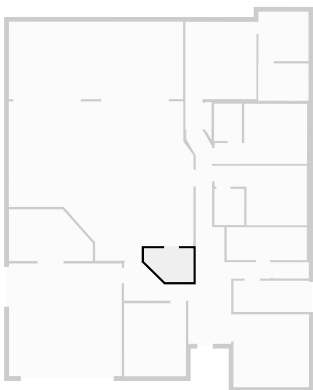

THIS FLOORPLAN IS PROVIDED WITHOUT WARRANTY OF ANY KIND. SENSOPIA DISCLAIMS ANY WARRANTY INCLUDING, WITHOUT LIMITATION, SATISFACTORY QUALITY OR ACCURACY OF DIMENSIONS.

Kitchen

Width: 8.46 m
 Length: 9.80 m
 Area: 67.84 m²
 Perimeter: 35.14 m
 Ceiling Height: 2.17 m

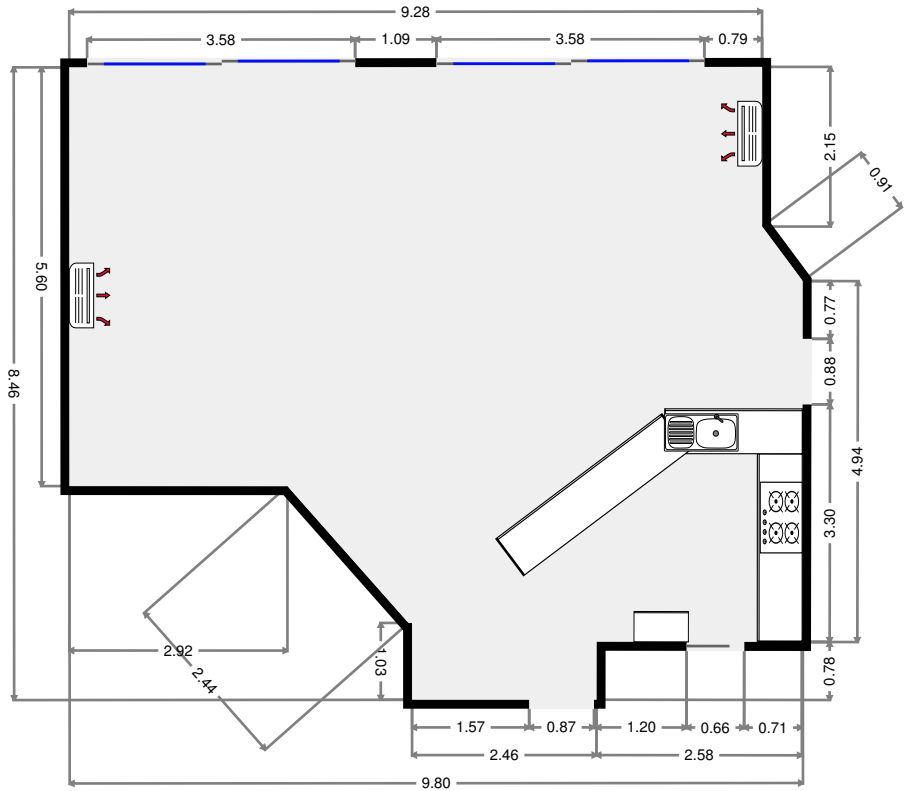
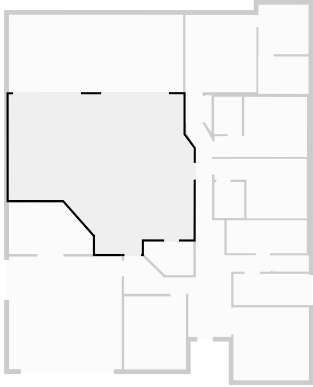

Closet

Width: 0.35 m
 Length: 1.98 m
 Area: 0.59 m²
 Perimeter: 4.41 m

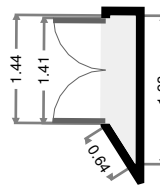
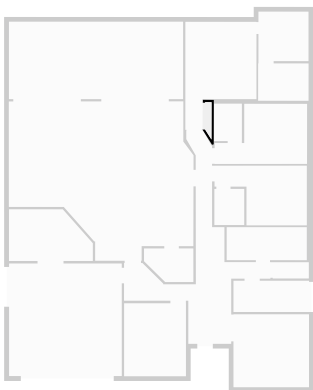

THIS FLOORPLAN IS PROVIDED WITHOUT WARRANTY OF ANY KIND. SENSOPIA DISCLAIMS ANY WARRANTY INCLUDING, WITHOUT LIMITATION, SATISFACTORY QUALITY OR ACCURACY OF DIMENSIONS.

Closet

Width: 1.98 m
 Length: 2.67 m
 Area: 5.30 m²
 Perimeter: 9.31 m

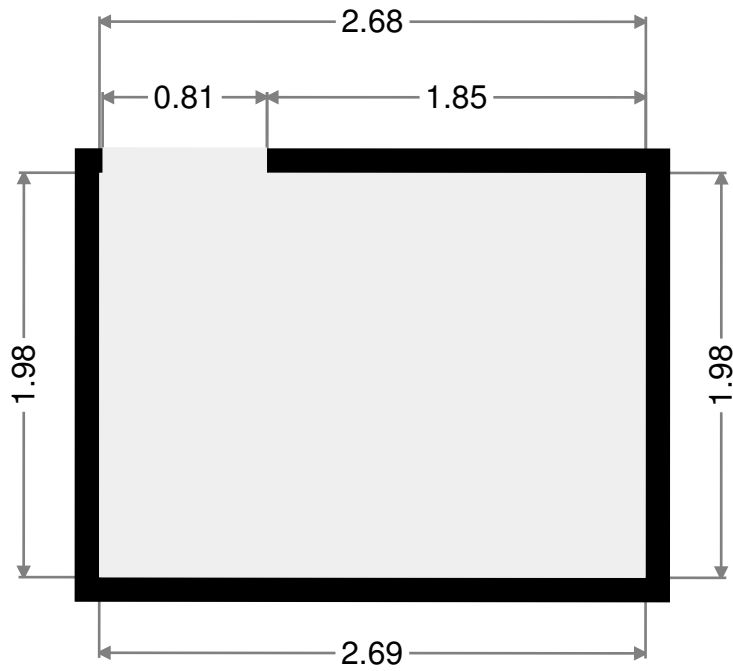
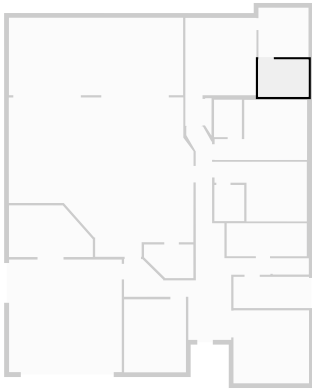

Bathroom

Width: 2.63 m
 Length: 2.66 m
 Area: 6.98 m²
 Perimeter: 10.57 m

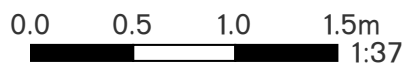
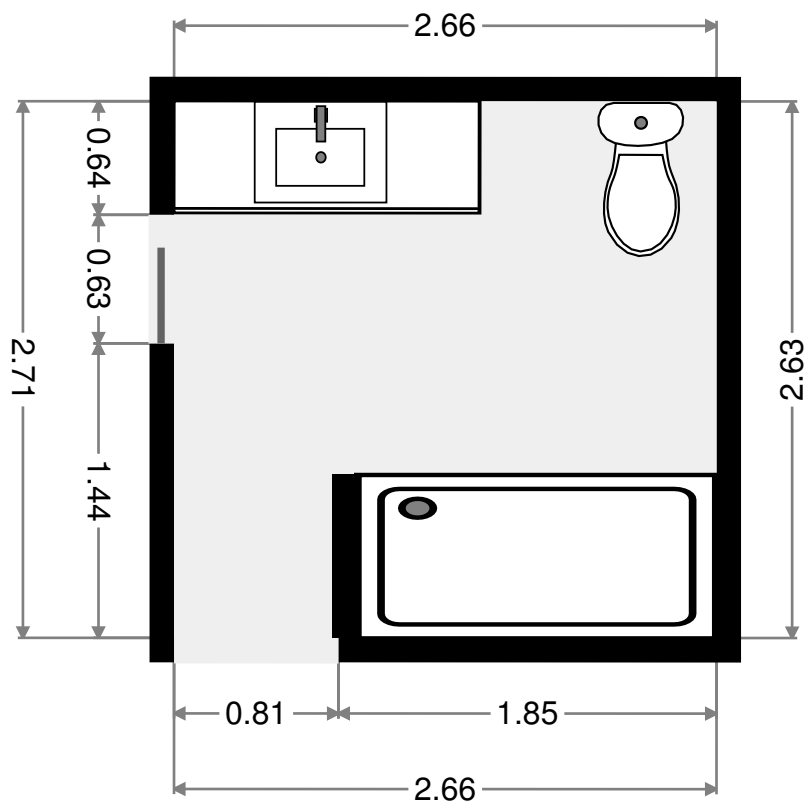
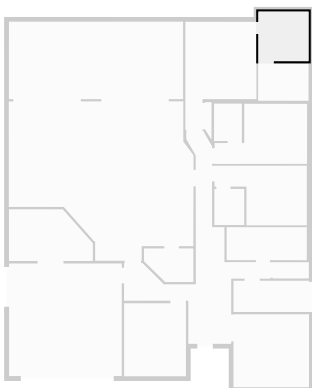

THIS FLOORPLAN IS PROVIDED WITHOUT WARRANTY OF ANY KIND. SENSOPIA DISCLAIMS ANY WARRANTY INCLUDING, WITHOUT LIMITATION, SATISFACTORY QUALITY OR ACCURACY OF DIMENSIONS.

Master Bedroom

Width: 3.77 m
 Length: 5.74 m
 Area: 16.96 m²
 Perimeter: 19.01 m

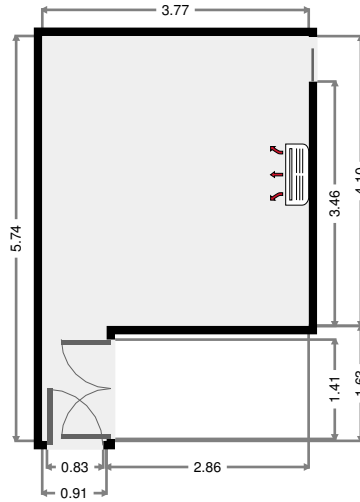
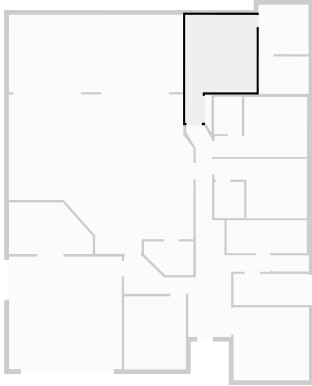

Entry

Width: 5.58 m
 Length: 10.53 m
 Area: 18.64 m²
 Perimeter: 31.84 m

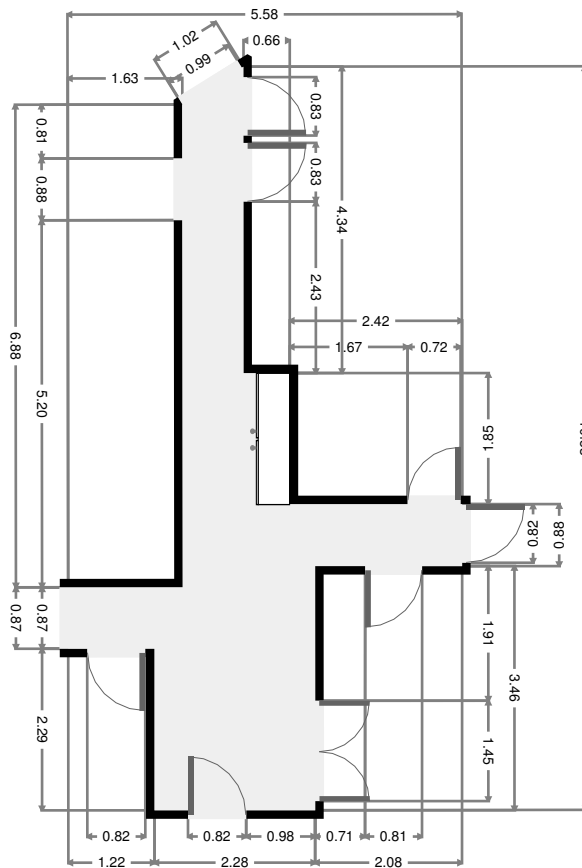
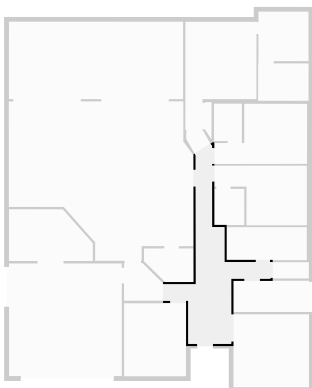

THIS FLOORPLAN IS PROVIDED WITHOUT WARRANTY OF ANY KIND. SENSOPIA DISCLAIMS ANY WARRANTY INCLUDING, WITHOUT LIMITATION, SATISFACTORY QUALITY OR ACCURACY OF DIMENSIONS.

Bedroom

Width: 3.18 m
 Length: 4.90 m
 Area: 12.37 m²
 Perimeter: 16.19 m

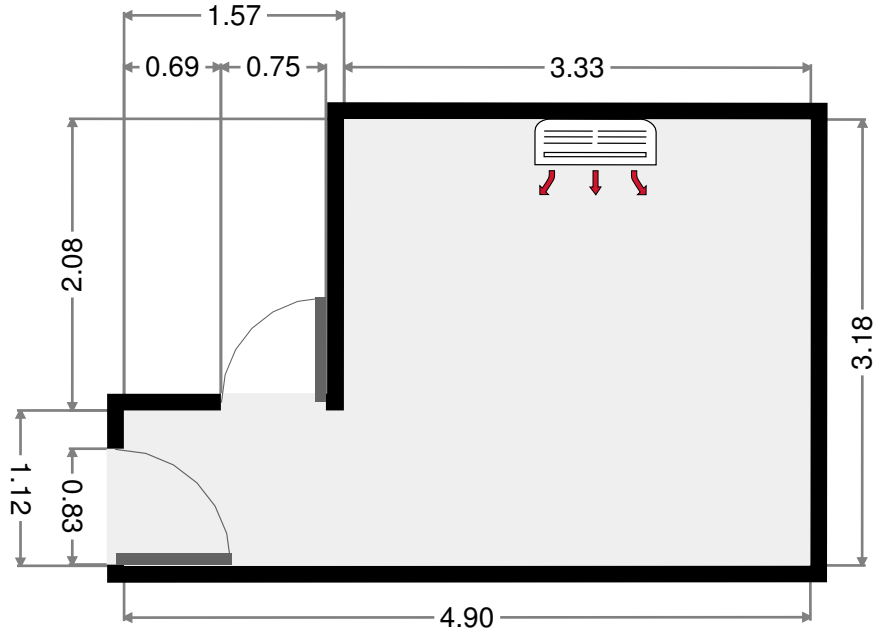
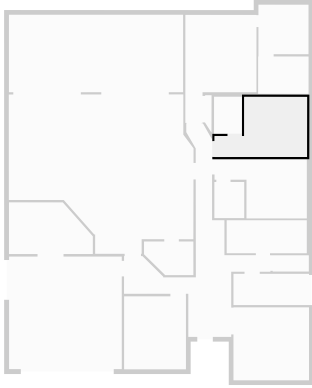

Hall

Width: 0.87 m
 Length: 0.98 m
 Area: 1.09 m²
 Perimeter: 4.11 m

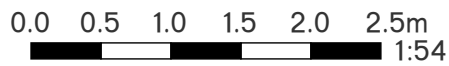
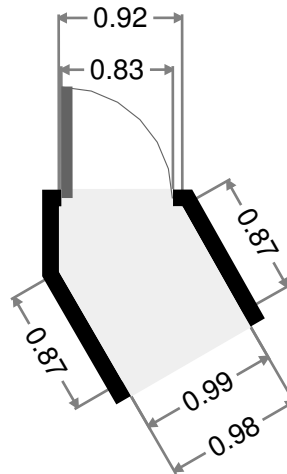
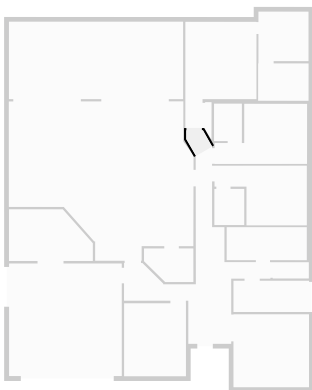

THIS FLOORPLAN IS PROVIDED WITHOUT WARRANTY OF ANY KIND. SENSOPIA DISCLAIMS ANY WARRANTY INCLUDING, WITHOUT LIMITATION, SATISFACTORY QUALITY OR ACCURACY OF DIMENSIONS.

WIR

Width: 1.58 m
 Length: 1.92 m
 Area: 3.04 m²
 Perimeter: 7.00 m

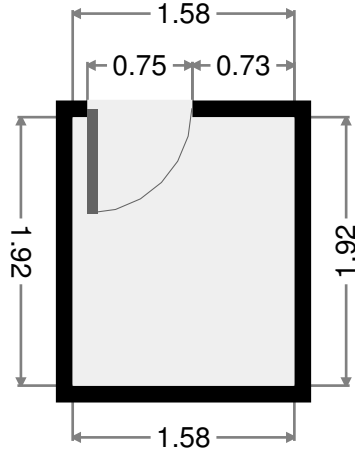
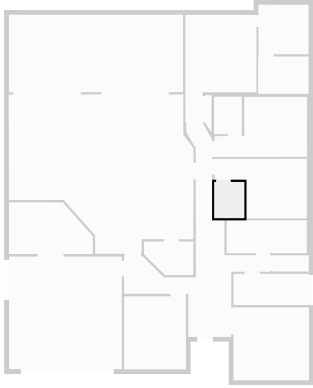

Bedroom

Width: 3.18 m
 Length: 4.90 m
 Area: 12.01 m²
 Perimeter: 16.12 m

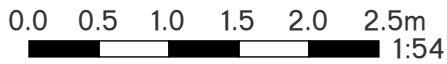
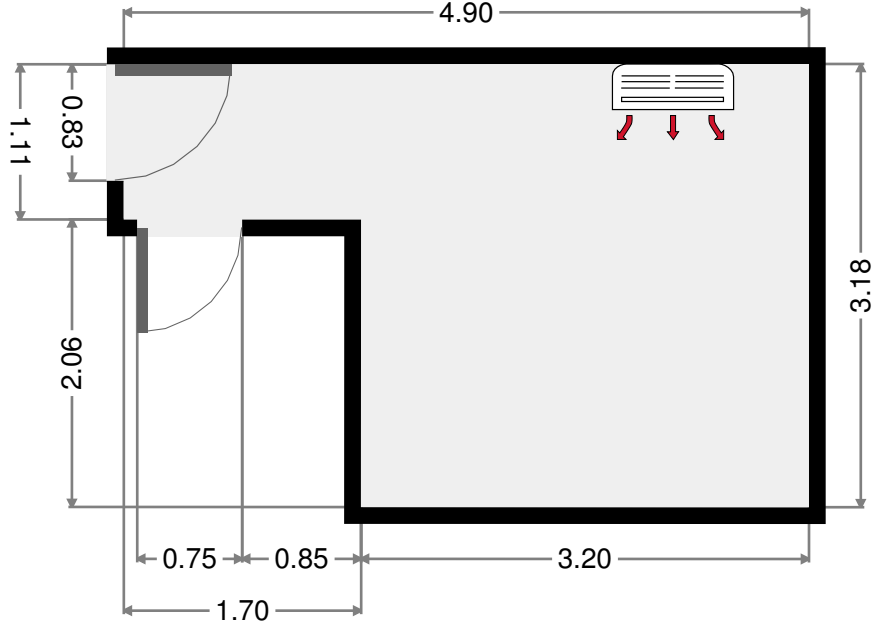
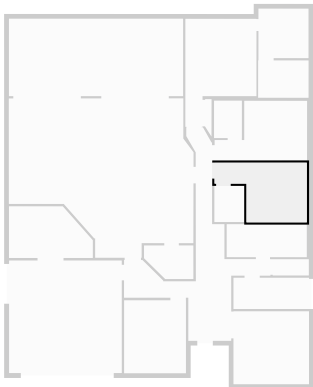

THIS FLOORPLAN IS PROVIDED WITHOUT WARRANTY OF ANY KIND. SENSOPIA DISCLAIMS ANY WARRANTY INCLUDING, WITHOUT LIMITATION, SATISFACTORY QUALITY OR ACCURACY OF DIMENSIONS.

Bedroom

Width: 3.28 m
 Length: 3.88 m
 Area: 12.70 m²
 Perimeter: 14.30 m

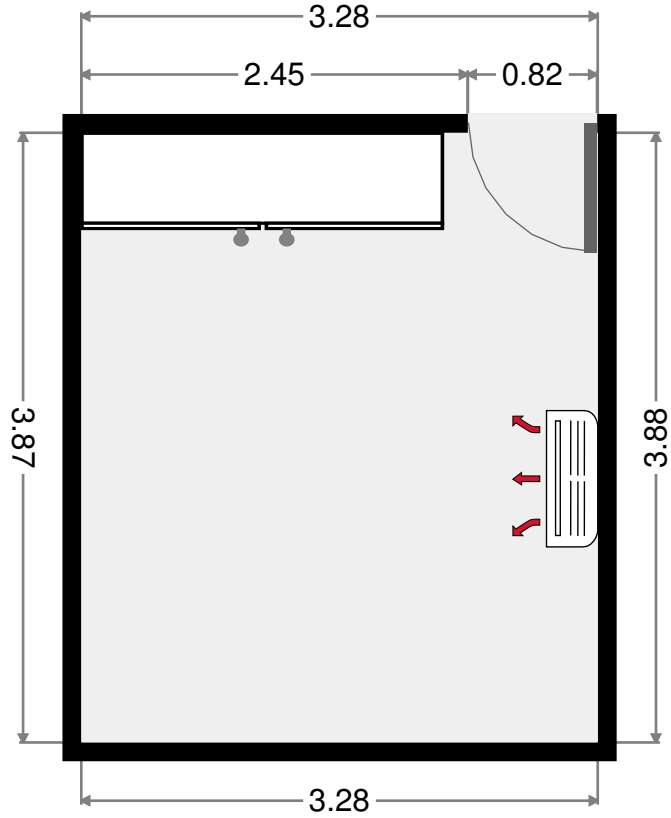
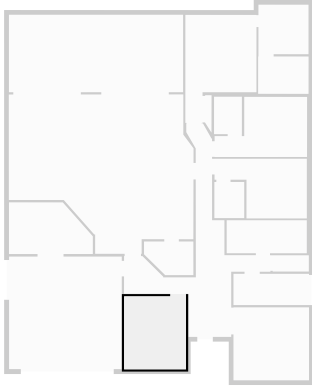

Bathroom

Width: 1.76 m
 Length: 4.25 m
 Area: 7.44 m²
 Perimeter: 12.00 m

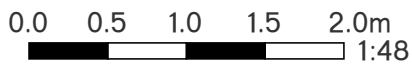
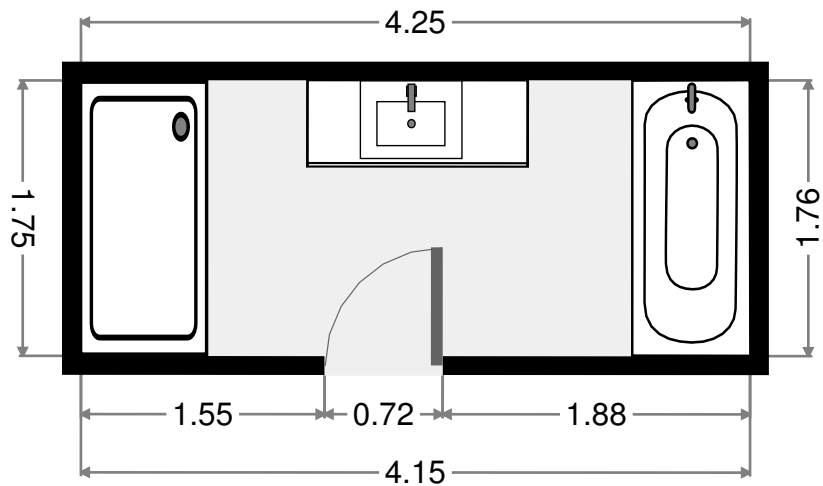
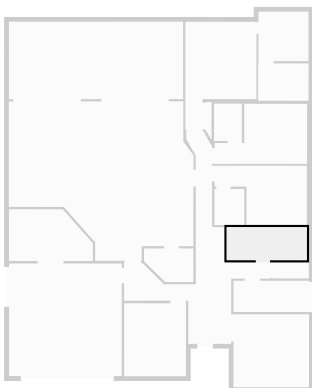

THIS FLOORPLAN IS PROVIDED WITHOUT WARRANTY OF ANY KIND. SENSOPIA DISCLAIMS ANY WARRANTY INCLUDING, WITHOUT LIMITATION, SATISFACTORY QUALITY OR ACCURACY OF DIMENSIONS.

Toilet

Width: 0.86 m
 Length: 1.92 m
 Area: 1.65 m²
 Perimeter: 5.56 m

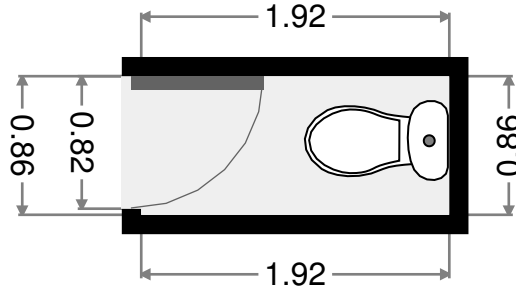
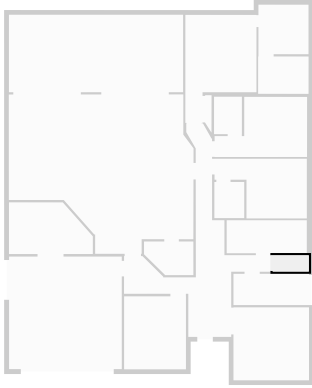

Laundry Room

Width: 1.66 m
 Length: 4.01 m
 Area: 6.65 m²
 Perimeter: 11.34 m

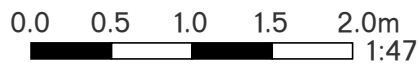
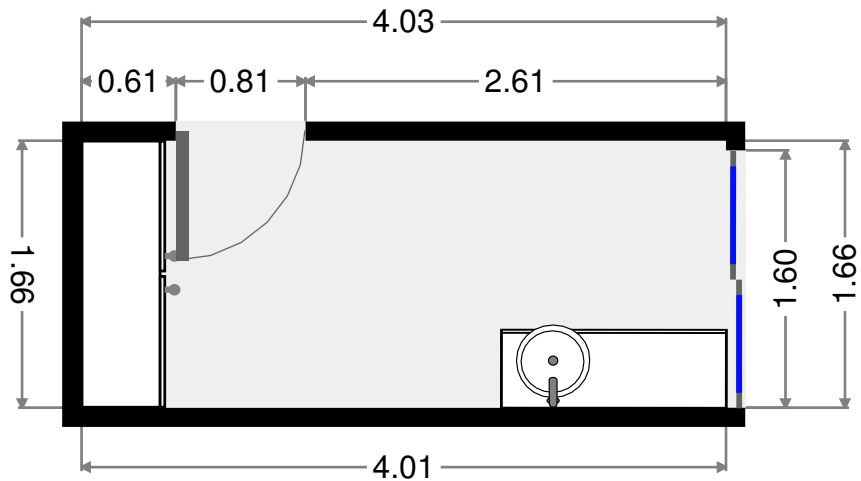
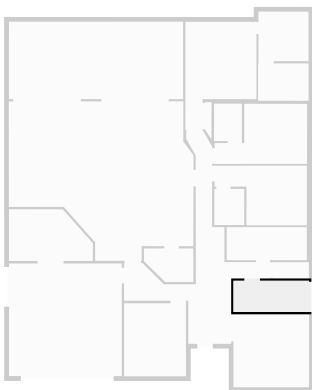

THIS FLOORPLAN IS PROVIDED WITHOUT WARRANTY OF ANY KIND. SENSOPIA DISCLAIMS ANY WARRANTY INCLUDING, WITHOUT LIMITATION, SATISFACTORY QUALITY OR ACCURACY OF DIMENSIONS.

Media Room

Width: 3.87 m
Length: 4.01 m
Area: 15.51 m²
Perimeter: 15.76 m

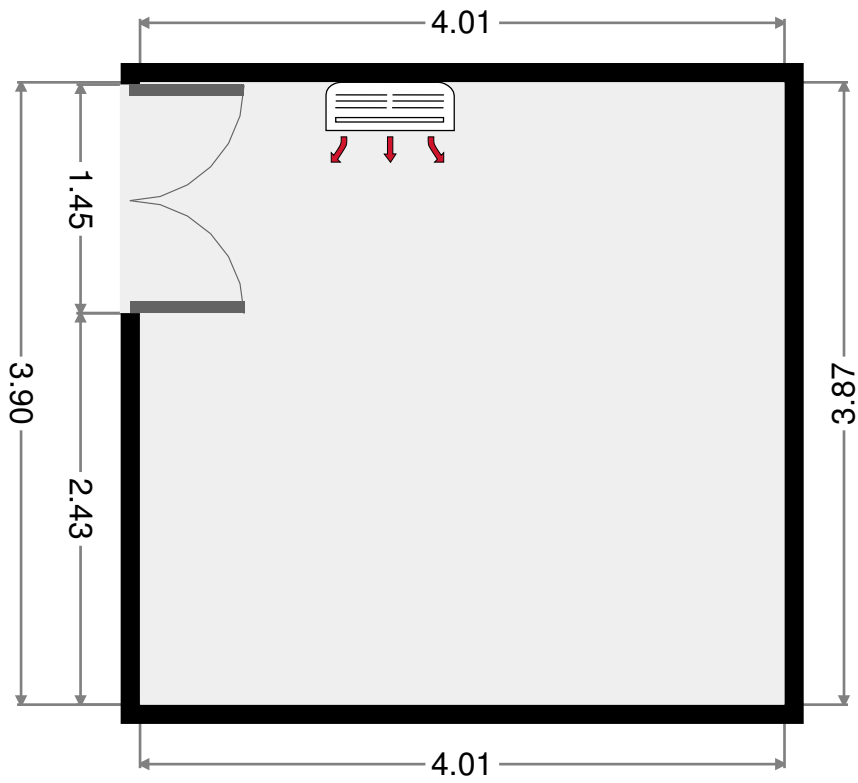
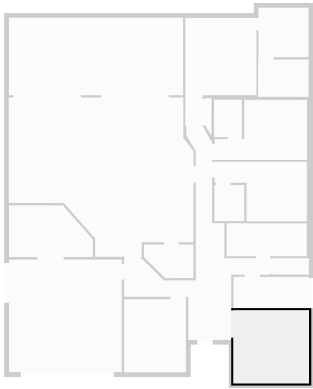

THIS FLOORPLAN IS PROVIDED WITHOUT WARRANTY OF ANY KIND. SENSOPIA DISCLAIMS ANY WARRANTY INCLUDING, WITHOUT LIMITATION, SATISFACTORY QUALITY OR ACCURACY OF DIMENSIONS.

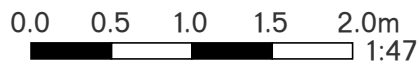

9 Skyline Drive

2017-03-21