

# 9 Laylee Court

**SUBMITTED BY**  
Ray White Rockhampton Casey  
stockers@cqoz.com

---

**CREATED ON**  
2022-11-14

---

**Floors**  
2

---

## ▼ Ground Floor

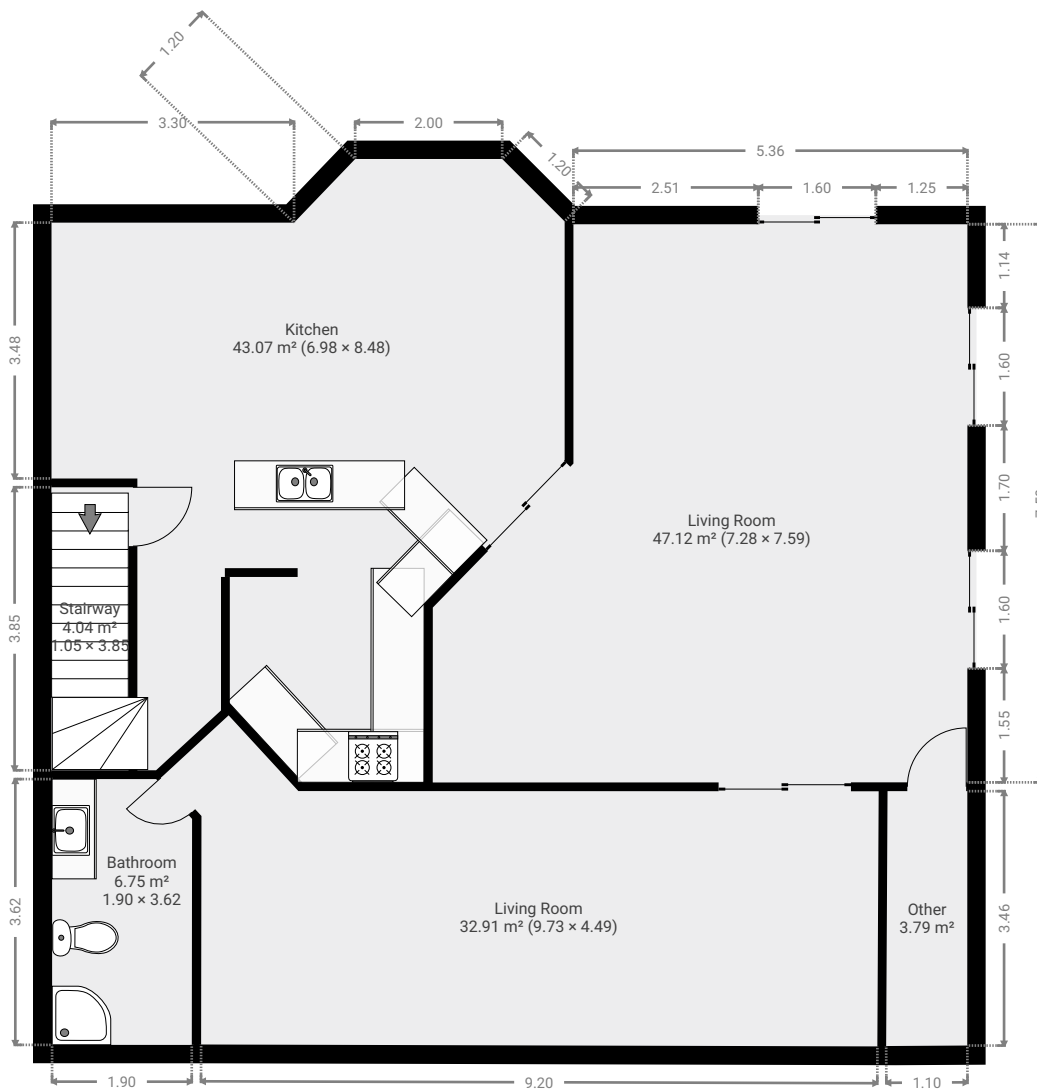

## ▼ Bathroom Ground Floor

WIDTH: 3.62 m • LENGTH: 1.90 m  
AREA: 6.75 m<sup>2</sup> • PERIMETER: 10.73 m

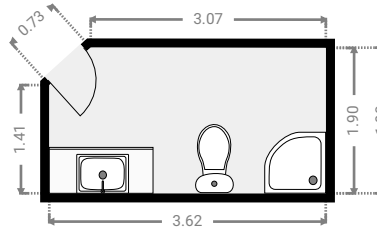
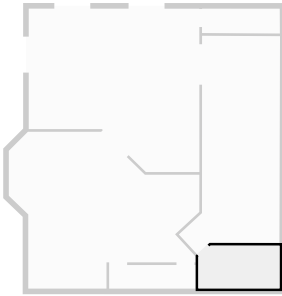

## ▼ Kitchen Ground Floor

WIDTH: 8.48 m • LENGTH: 6.98 m  
AREA: 43.07 m<sup>2</sup> • PERIMETER: 29.46 m

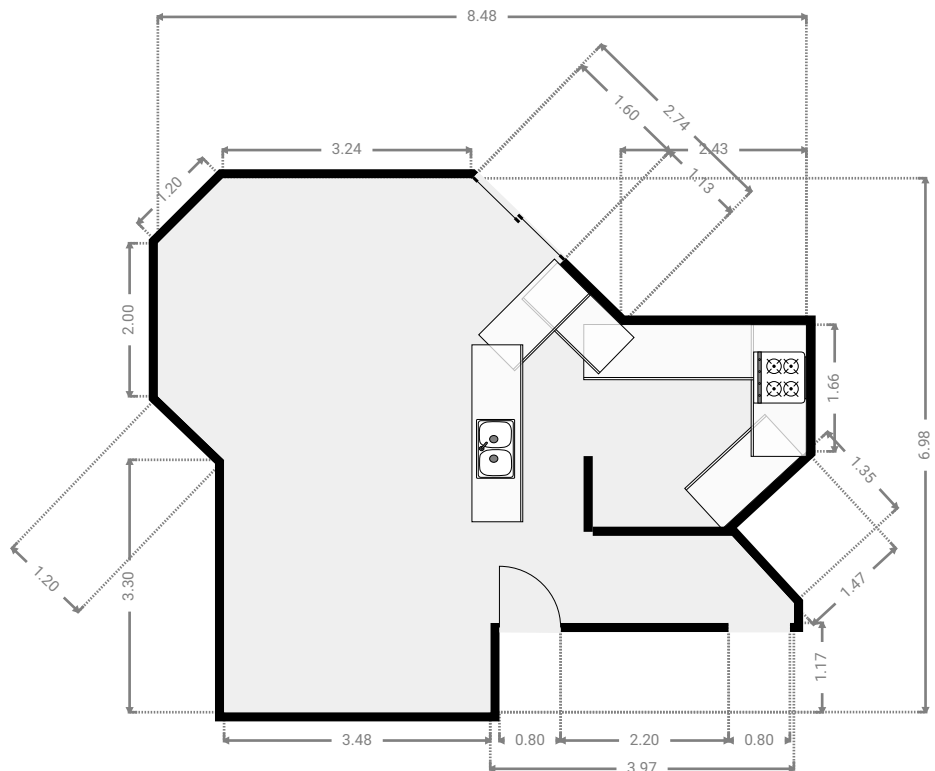
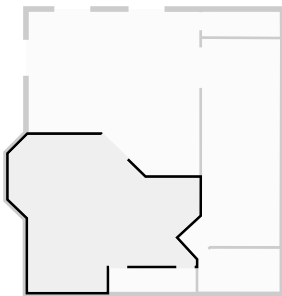

▼ **Living Room**  
Ground Floor

WIDTH: 4.49 m • LENGTH: 9.73 m  
AREA: 32.91 m<sup>2</sup> • PERIMETER: 27.03 m

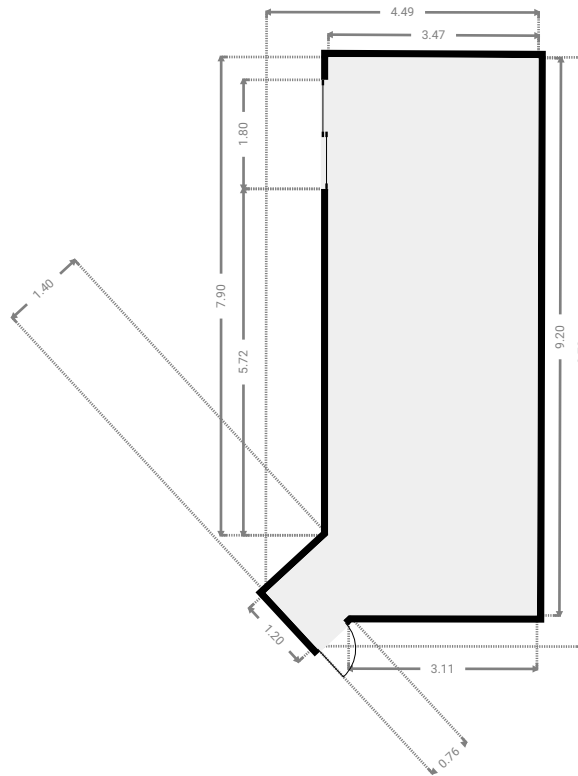
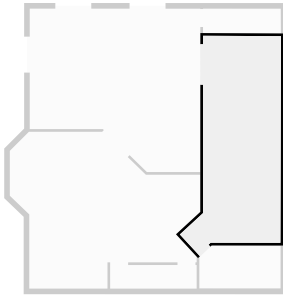

▼ **Living Room**  
Ground Floor

WIDTH: 7.59 m • LENGTH: 7.28 m  
AREA: 47.12 m<sup>2</sup> • PERIMETER: 28.60 m

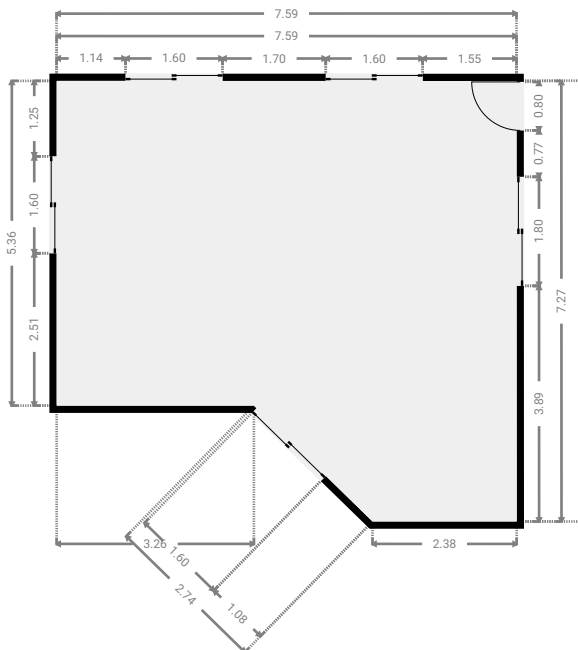
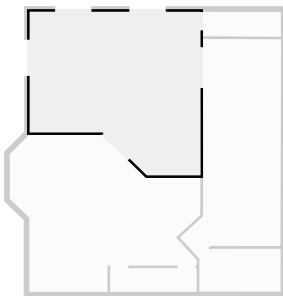

## ▼ Other Ground Floor

WIDTH: 3.47 m • LENGTH: 1.13 m  
AREA: 3.79 m<sup>2</sup> • PERIMETER: 9.12 m

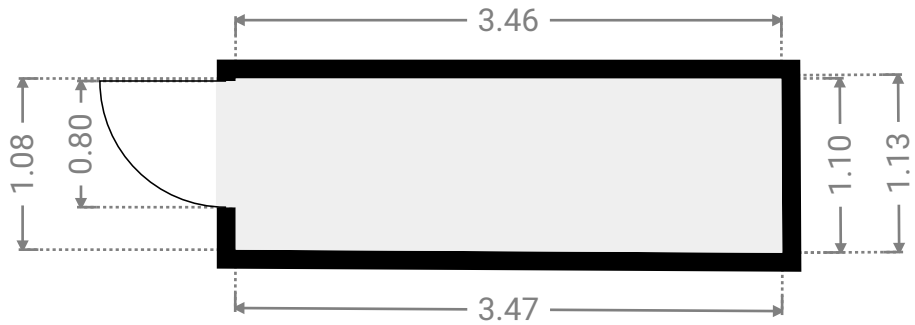
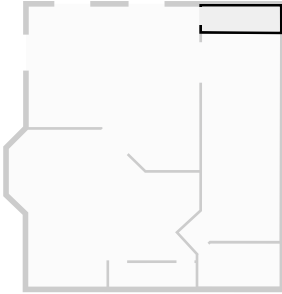

## ▼ Stairway Ground Floor

WIDTH: 3.85 m • LENGTH: 1.05 m  
AREA: 4.04 m<sup>2</sup> • PERIMETER: 9.80 m

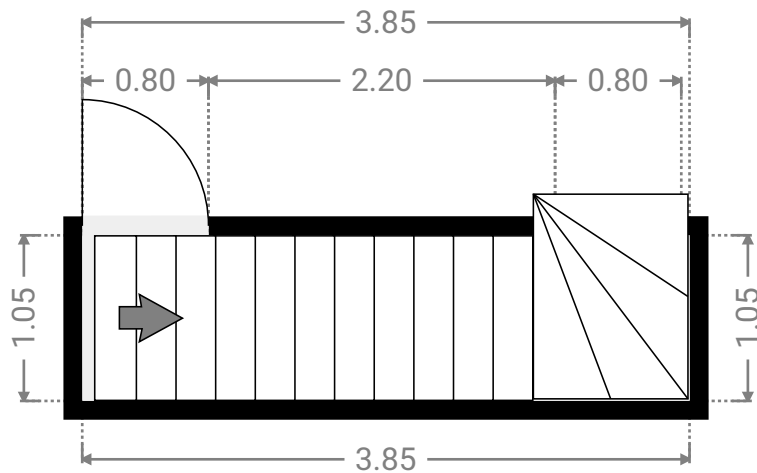
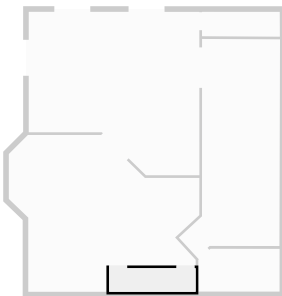

## ▼ 1st Floor

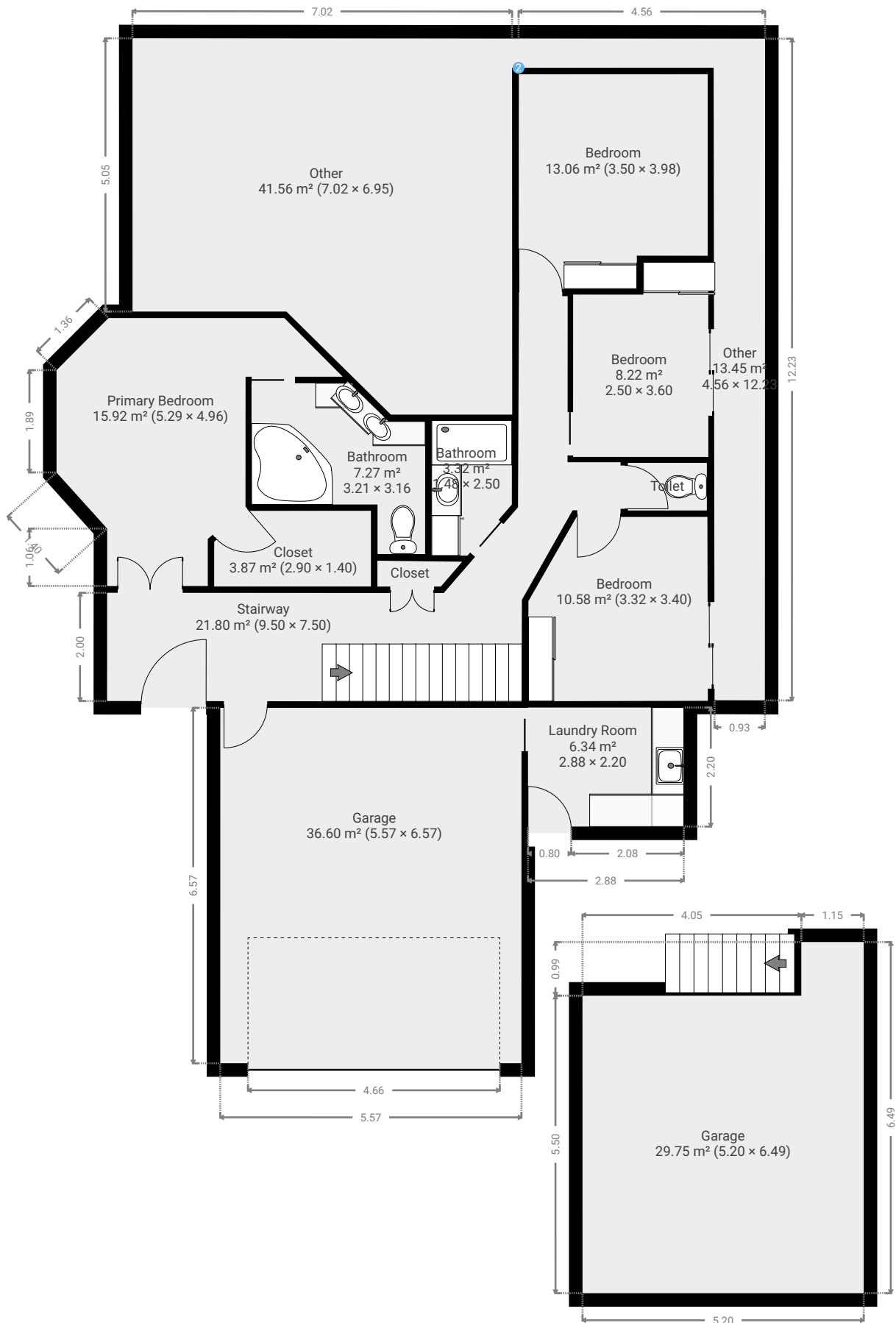

THIS FLOORPLAN IS PROVIDED WITHOUT WARRANTY OF ANY KIND. SENSOPIA DISCLAIMS ANY WARRANTY INCLUDING, WITHOUT LIMITATION, SATISFACTORY QUALITY OR ACCURACY OF DIMENSIONS.

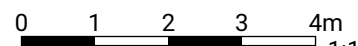

▼ Bathroom  
1st Floor

WIDTH: 3.21 m • LENGTH: 3.16 m  
AREA: 7.27 m<sup>2</sup> • PERIMETER: 12.33 m

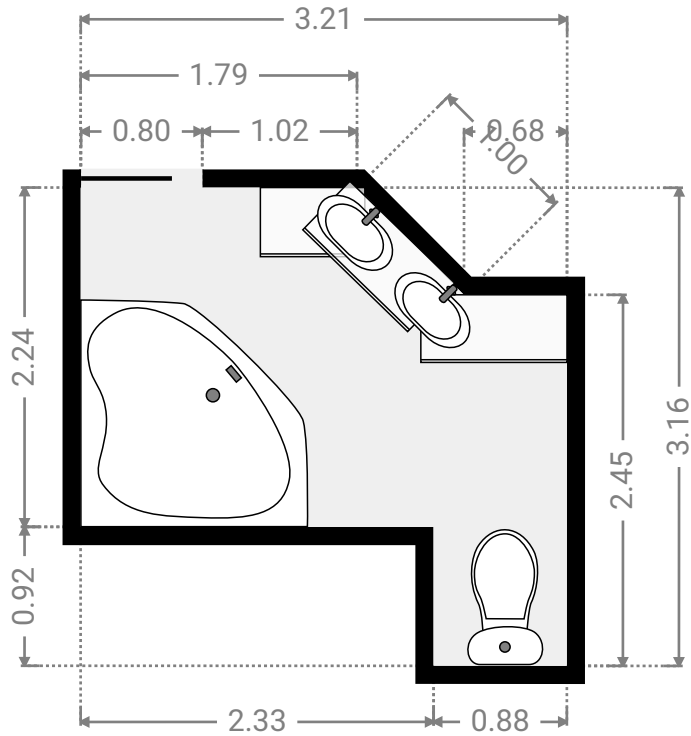
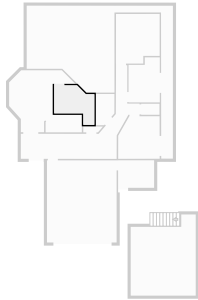

▼ Bathroom  
1st Floor

WIDTH: 1.48 m • LENGTH: 2.50 m  
AREA: 3.32 m<sup>2</sup> • PERIMETER: 7.45 m

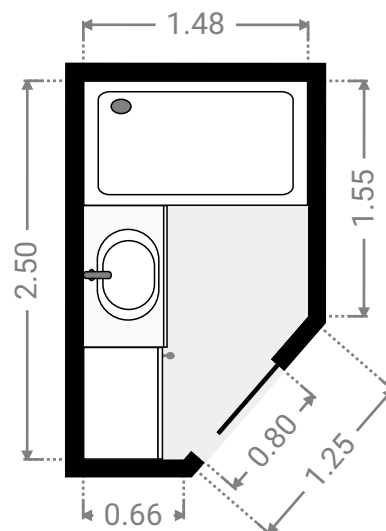
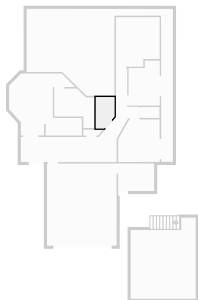

## ▼ Bedroom 1st Floor

WIDTH: 3.32 m • LENGTH: 3.40 m  
AREA: 10.58 m<sup>2</sup> • PERIMETER: 12.78 m

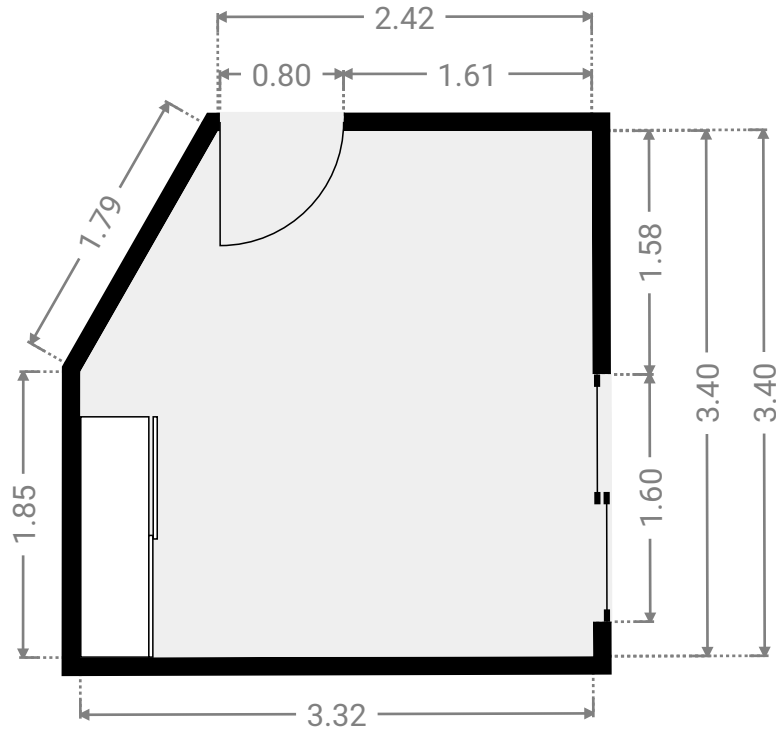
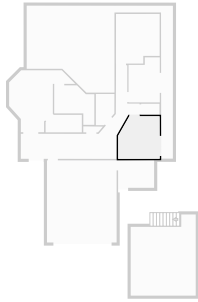

## ▼ Bedroom 1st Floor

WIDTH: 2.50 m • LENGTH: 3.60 m  
AREA: 8.22 m<sup>2</sup> • PERIMETER: 12.20 m

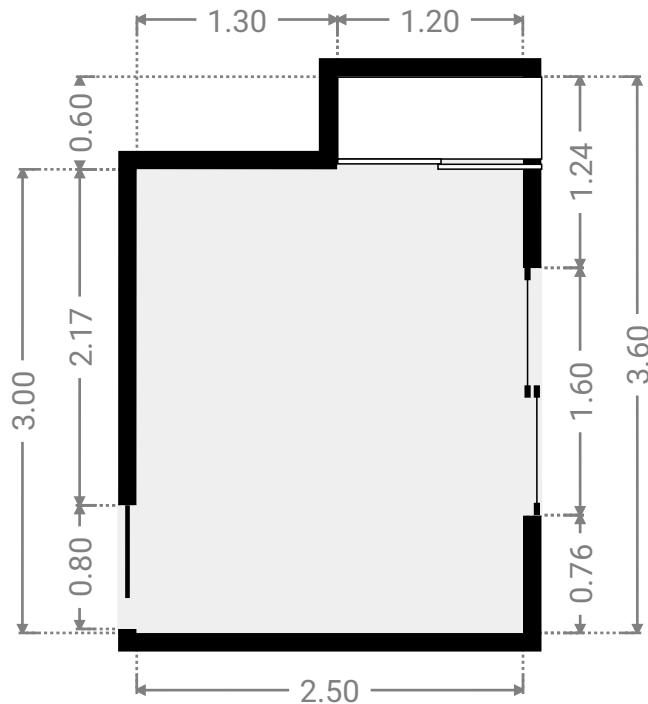
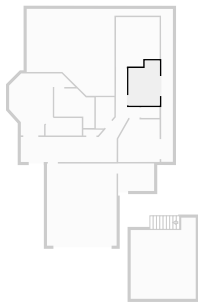



## ▼ Bedroom 1st Floor

WIDTH: 3.50 m • LENGTH: 3.98 m  
AREA: 13.06 m<sup>2</sup> • PERIMETER: 14.93 m

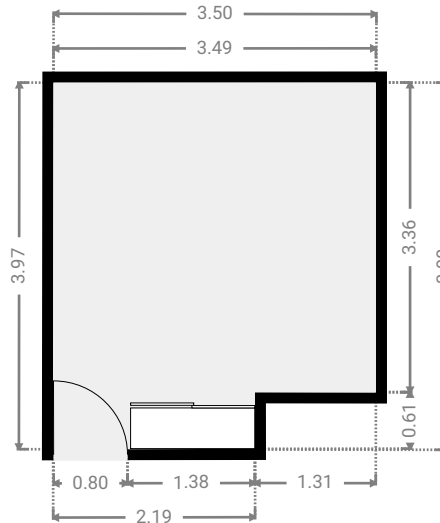
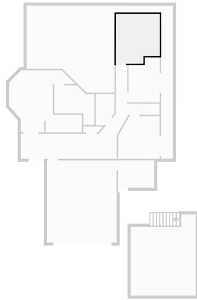

## ▼ Garage 1st Floor

WIDTH: 5.57 m • LENGTH: 6.57 m  
AREA: 36.60 m<sup>2</sup> • PERIMETER: 24.28 m

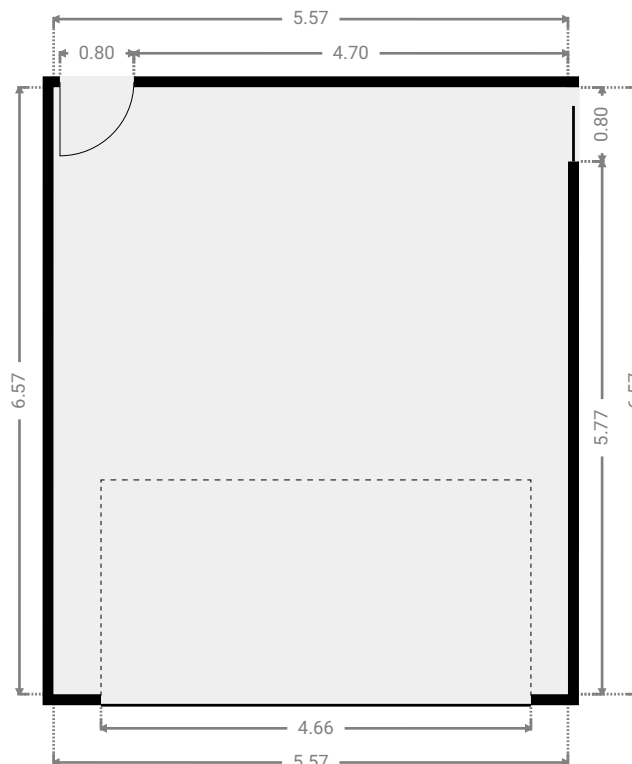
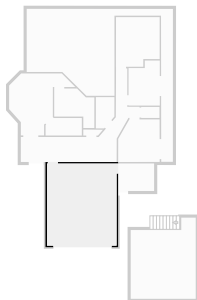

## ▼ Garage 1st Floor

WIDTH: 5.20 m • LENGTH: 6.49 m  
AREA: 29.75 m<sup>2</sup> • PERIMETER: 23.38 m

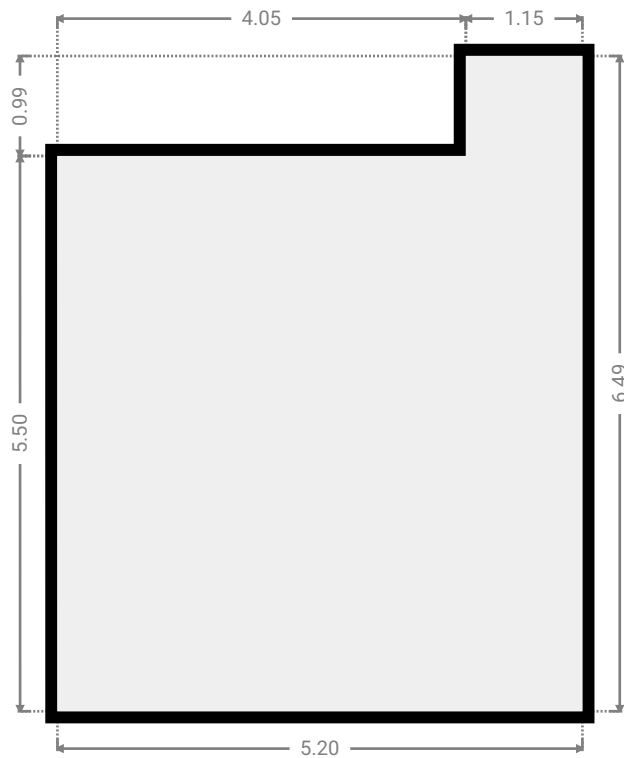
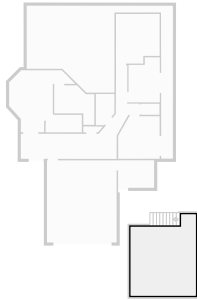

## ▼ Laundry Room 1st Floor

WIDTH: 2.88 m • LENGTH: 2.20 m  
AREA: 6.34 m<sup>2</sup> • PERIMETER: 10.16 m

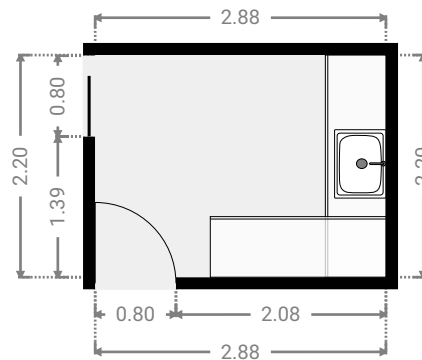
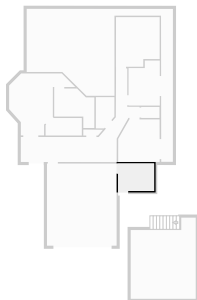

# 9 Laylee Court

FLOORS: 2



## ▼ Other 1st Floor

WIDTH: 7.02 m • LENGTH: 6.95 m  
AREA: 41.56 m<sup>2</sup> • PERIMETER: 26.82 m

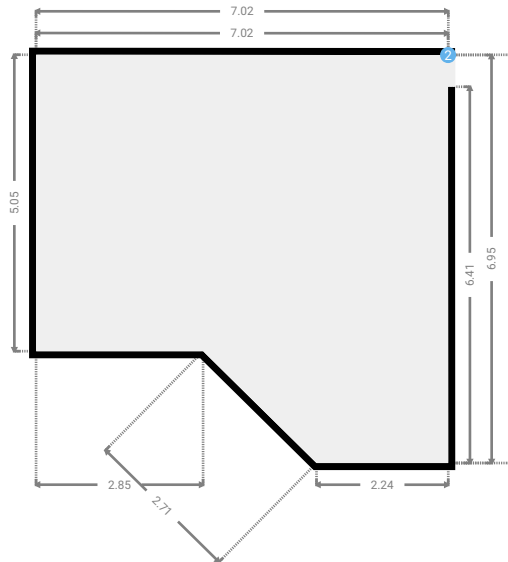
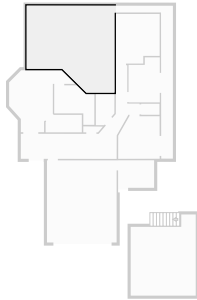

## ▼ Other 1st Floor

WIDTH: 4.56 m • LENGTH: 12.23 m  
AREA: 13.45 m<sup>2</sup> • PERIMETER: 33.56 m

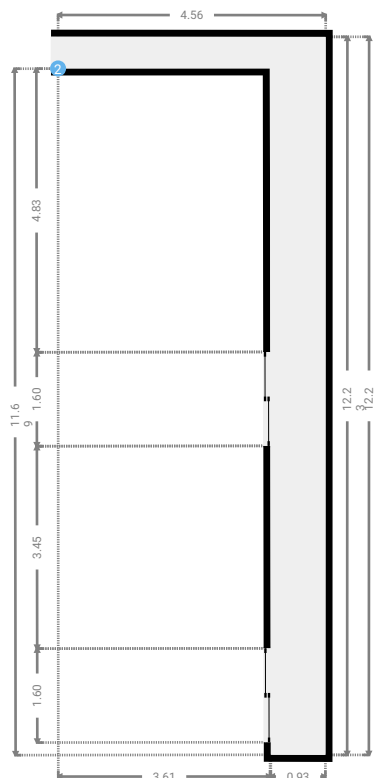
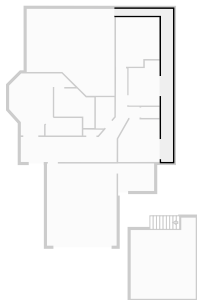

THIS FLOORPLAN IS PROVIDED WITHOUT WARRANTY OF ANY KIND. SENSOPIA DISCLAIMS ANY WARRANTY INCLUDING, WITHOUT LIMITATION, SATISFACTORY QUALITY OR ACCURACY OF DIMENSIONS.

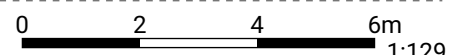

▼ Other/1st Floor

2 OPENING

Height  
0.00 m



▼ **Primary Bedroom**  
1st Floor

WIDTH: 5.29 m • LENGTH: 4.96 m  
AREA: 15.92 m<sup>2</sup> • PERIMETER: 18.34 m

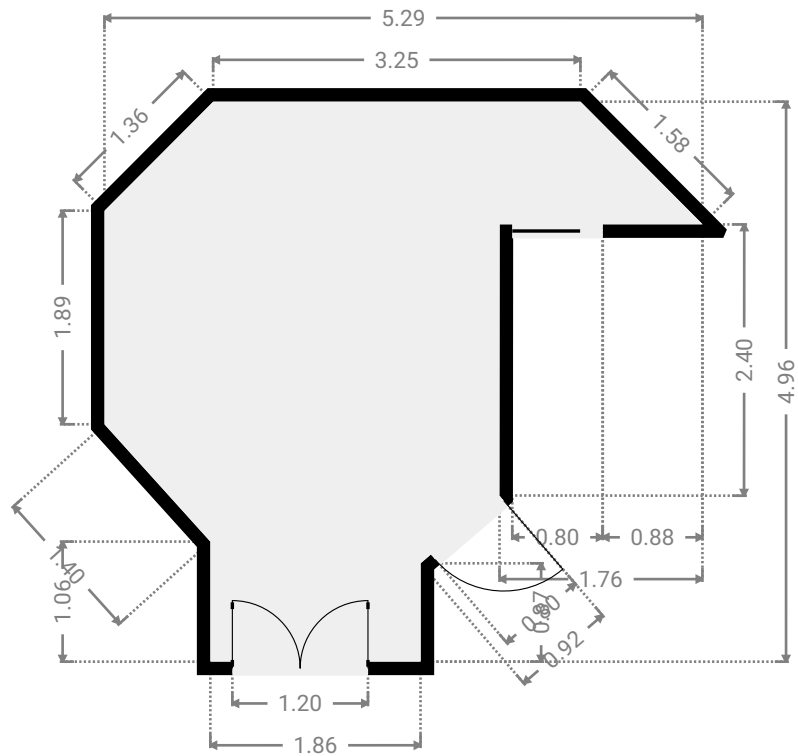
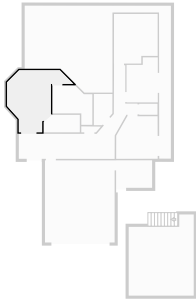

▼ **Closet**  
1st Floor

WIDTH: 2.90 m • LENGTH: 1.40 m  
AREA: 3.87 m<sup>2</sup> • PERIMETER: 8.24 m

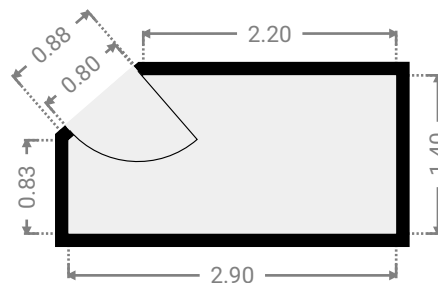
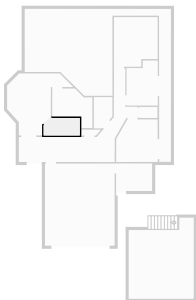

▼ **Stairway**  
1st Floor

WIDTH: 9.50 m • LENGTH: 7.50 m  
AREA: 21.80 m<sup>2</sup> • PERIMETER: 32.41 m

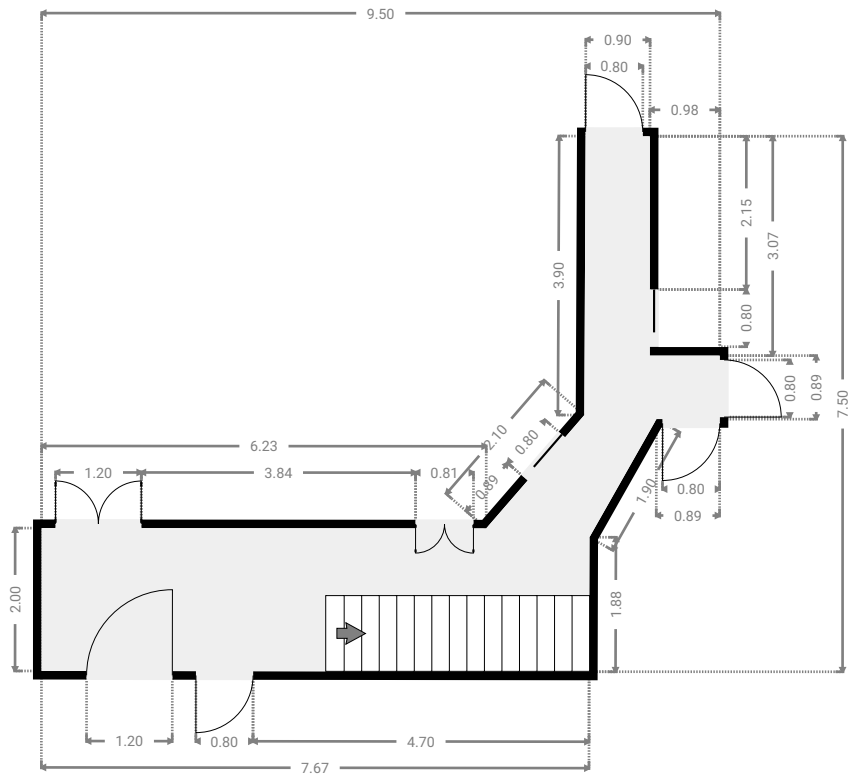
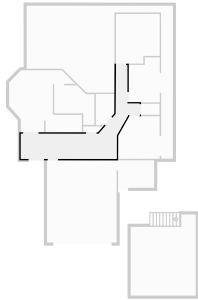

▼ **Closet**  
1st Floor

WIDTH: 1.57 m • LENGTH: 0.48 m  
AREA: 0.64 m<sup>2</sup> • PERIMETER: 3.82 m

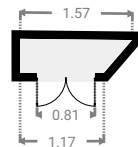
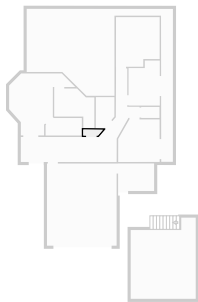

## ▼ Toilet 1st Floor

WIDTH: 1.46 m • LENGTH: 0.88 m  
AREA: 1.28 m<sup>2</sup> • PERIMETER: 4.68 m

