

9 Dally Street Wandal

Ground Floor

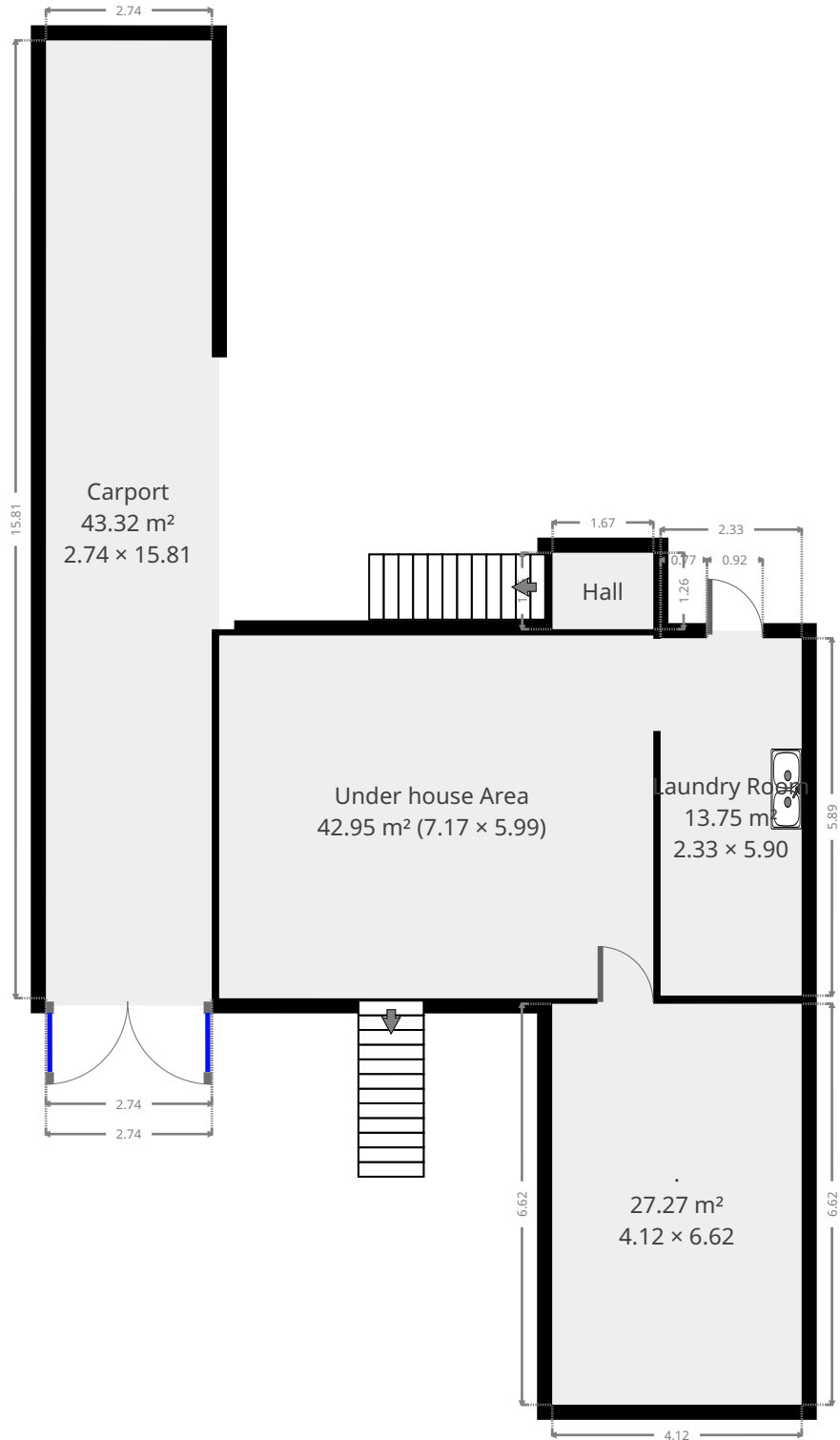

THIS FLOORPLAN IS PROVIDED WITHOUT WARRANTY OF ANY KIND. SENSOPIA DISCLAIMS ANY WARRANTY INCLUDING, WITHOUT LIMITATION, SATISFACTORY QUALITY OR ACCURACY OF DIMENSIONS.



9 Dally Street Wandal

Carport

Width: 2.74 m
Length: 15.81 m
Area: 43.32 m²
Perimeter: 37.10 m

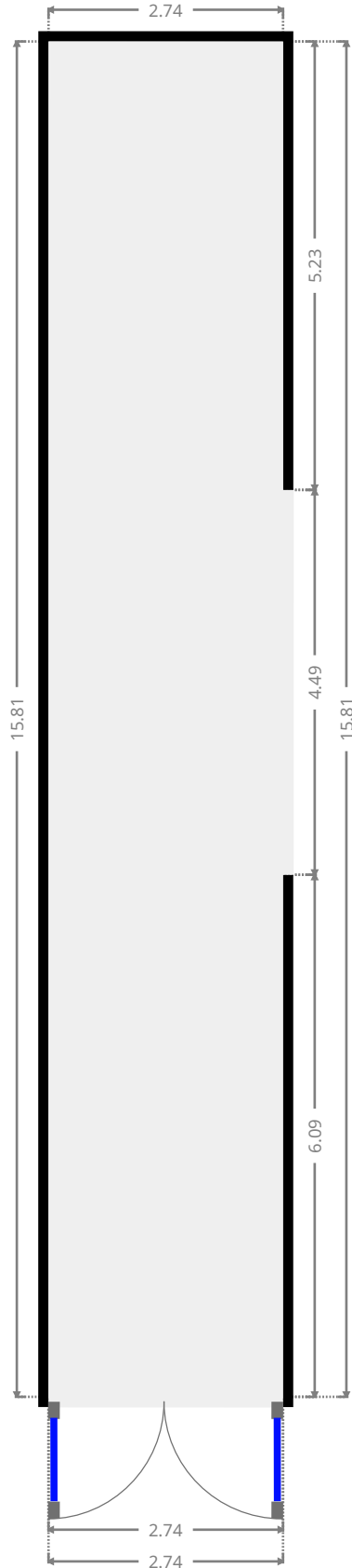
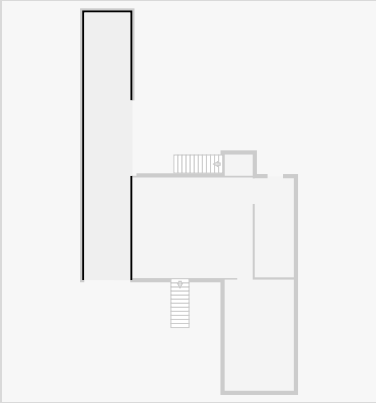

THIS FLOORPLAN IS PROVIDED WITHOUT WARRANTY OF ANY KIND. SENSOPIA DISCLAIMS ANY WARRANTY INCLUDING, WITHOUT LIMITATION, SATISFACTORY QUALITY OR ACCURACY OF DIMENSIONS.

9 Dally Street Wandal

Under house Area

Width: 5.99 m
 Length: 7.17 m
 Area: 42.95 m²
 Perimeter: 26.32 m

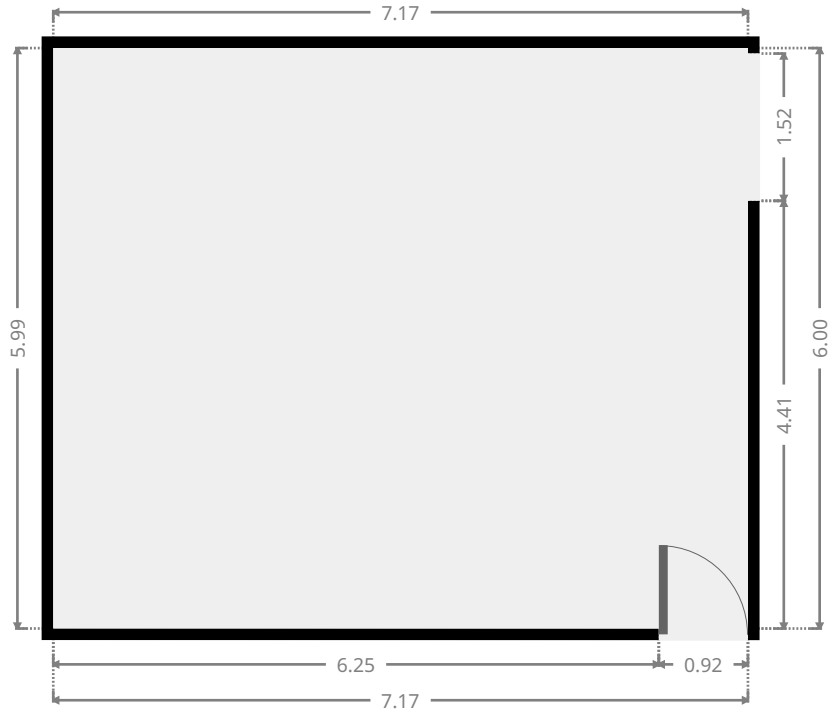
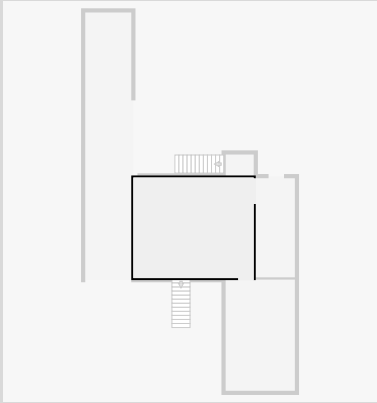

Laundry Room

Width: 2.33 m
 Length: 5.90 m
 Area: 13.75 m²
 Perimeter: 16.46 m

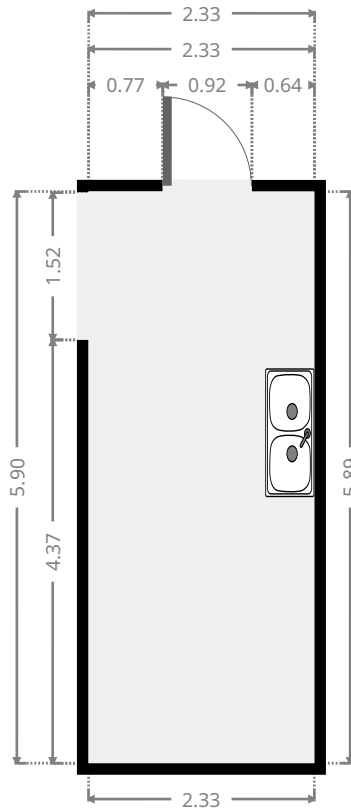
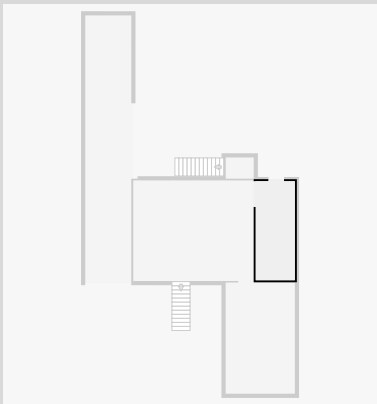

THIS FLOORPLAN IS PROVIDED WITHOUT WARRANTY OF ANY KIND. SENSOPIA DISCLAIMS ANY WARRANTY INCLUDING, WITHOUT LIMITATION, SATISFACTORY QUALITY OR ACCURACY OF DIMENSIONS.

9 Dally Street Wandal

•
Width: 4.12 m
Length: 6.62 m
Area: 27.27 m²
Perimeter: 21.48 m

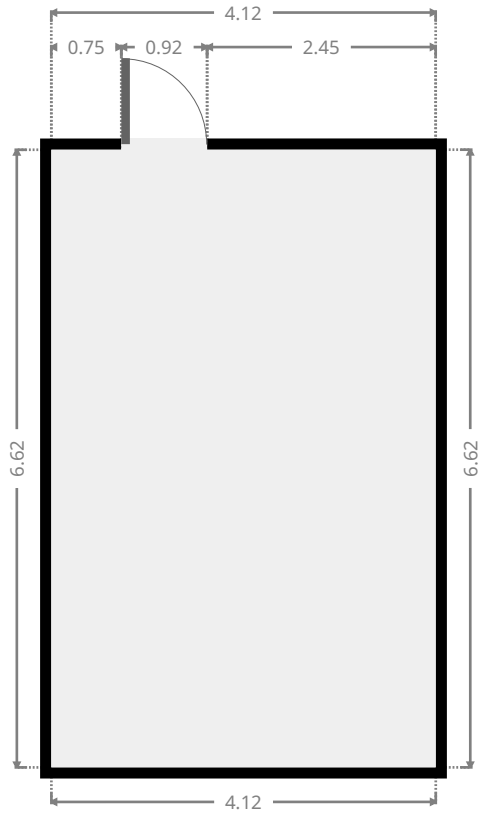
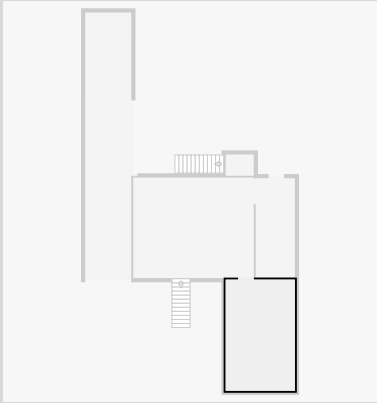

Hall

Width: 1.26 m
Length: 1.67 m
Area: 2.10 m²
Perimeter: 5.85 m

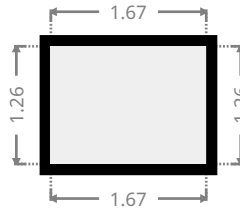
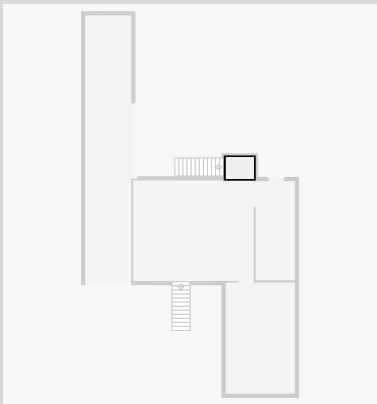

9 Dally Street Wandal

1st Floor

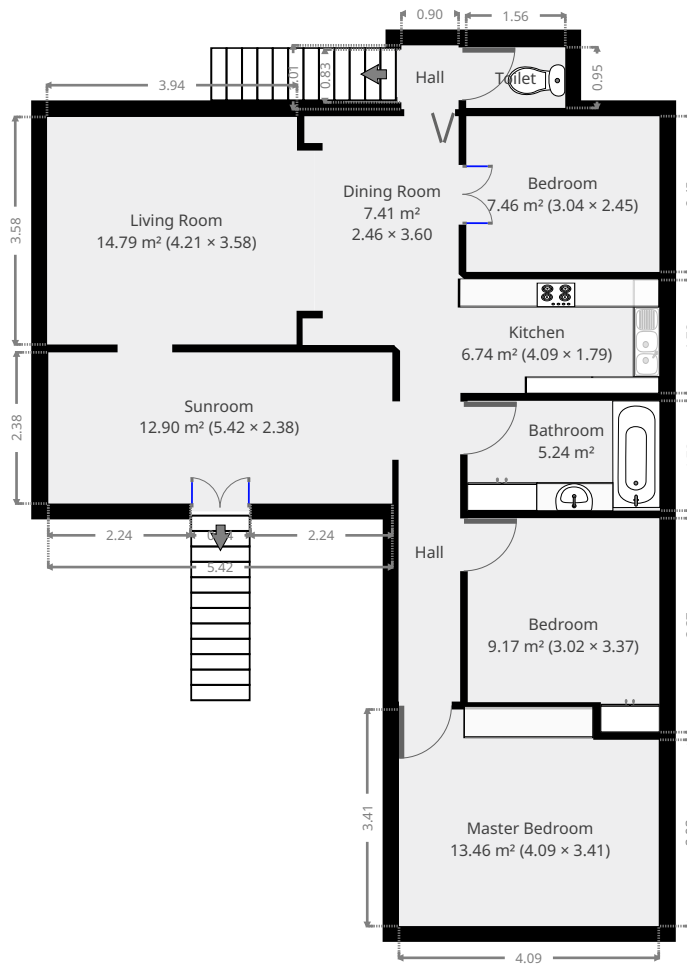

THIS FLOORPLAN IS PROVIDED WITHOUT WARRANTY OF ANY KIND. SENSOPIA DISCLAIMS ANY WARRANTY INCLUDING, WITHOUT LIMITATION, SATISFACTORY QUALITY OR ACCURACY OF DIMENSIONS.



9 Dally Street Wandal

Sunroom

Width: 2.38 m
 Length: 5.42 m
 Area: 12.90 m²
 Perimeter: 15.60 m

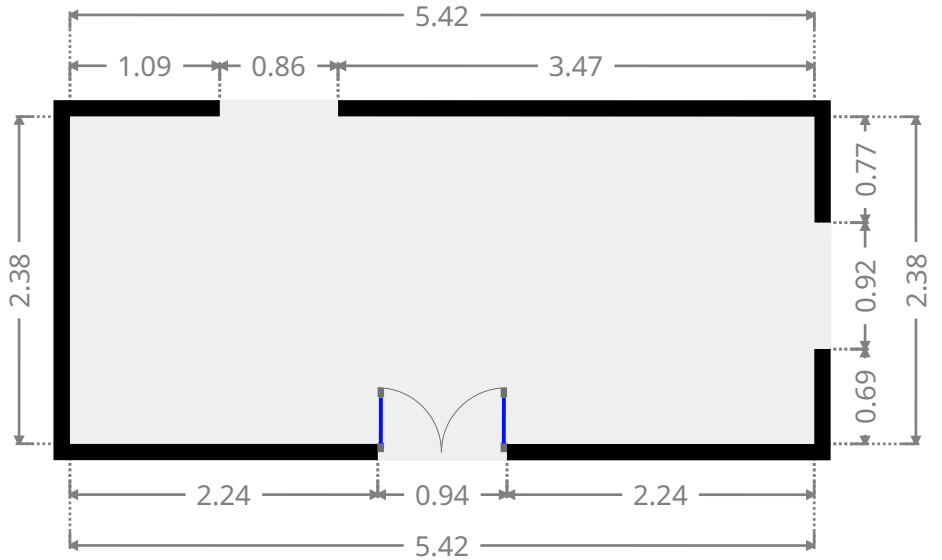
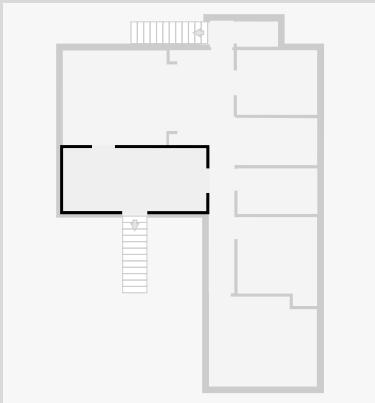

Living Room

Width: 3.58 m
 Length: 4.21 m
 Area: 14.79 m²
 Perimeter: 15.59 m

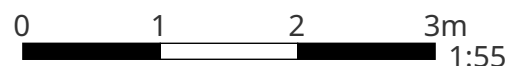
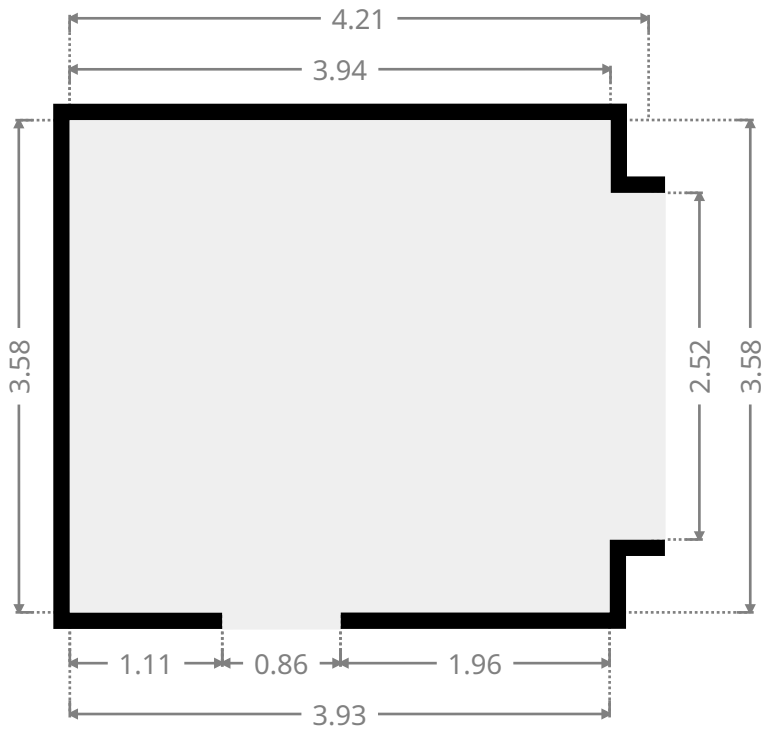
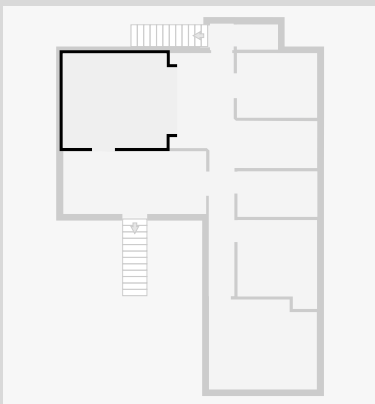

THIS FLOORPLAN IS PROVIDED WITHOUT WARRANTY OF ANY KIND. SENSOPIA DISCLAIMS ANY WARRANTY INCLUDING, WITHOUT LIMITATION, SATISFACTORY QUALITY OR ACCURACY OF DIMENSIONS.

9 Dally Street Wandal

Dining Room

Width: 2.46 m
 Length: 3.60 m
 Area: 7.41 m²
 Perimeter: 12.08 m

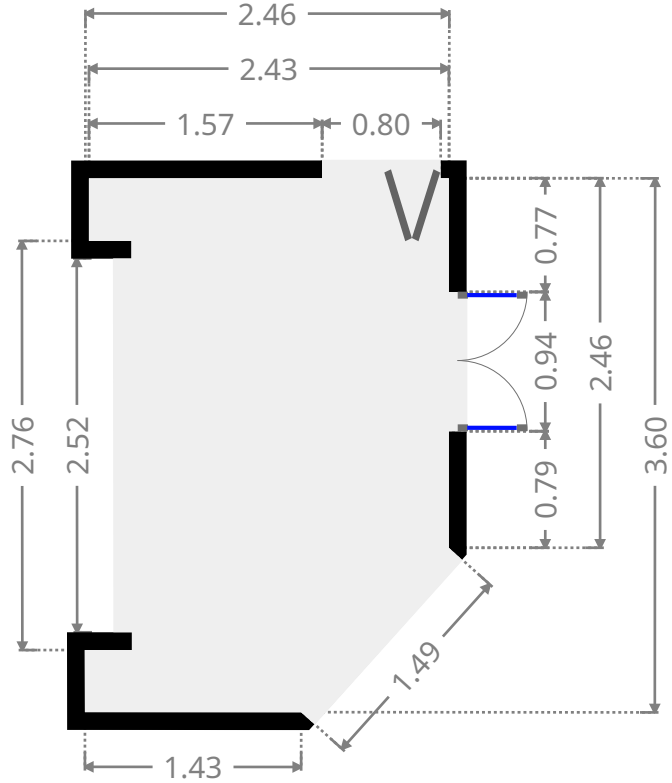
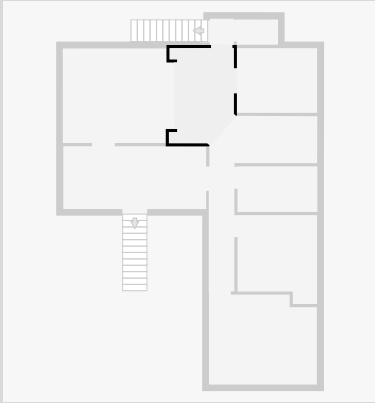

Hall

Width: 0.90 m
 Length: 1.01 m
 Area: 0.90 m²
 Perimeter: 3.81 m

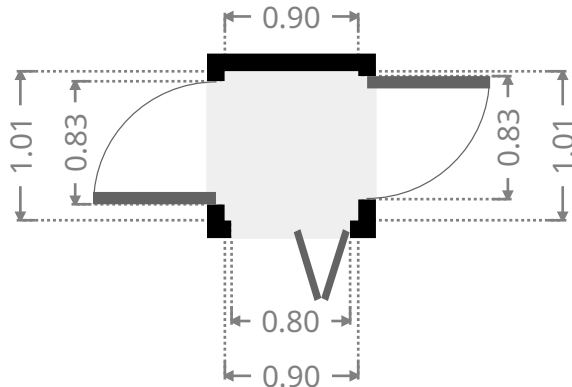
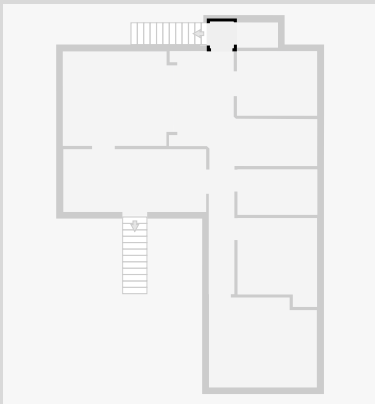

9 Dally Street Wandal

Toilet / Half Bath

Width: 0.96 m
 Length: 1.56 m
 Area: 1.49 m²
 Perimeter: 5.03 m

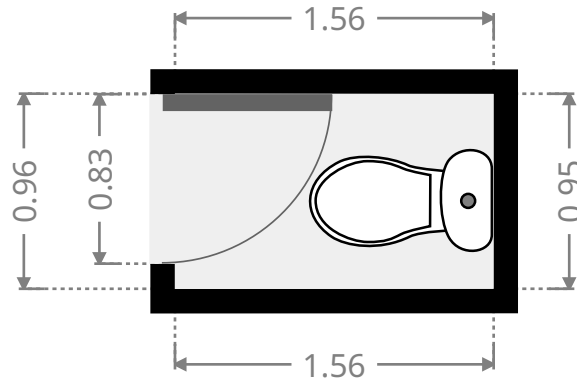
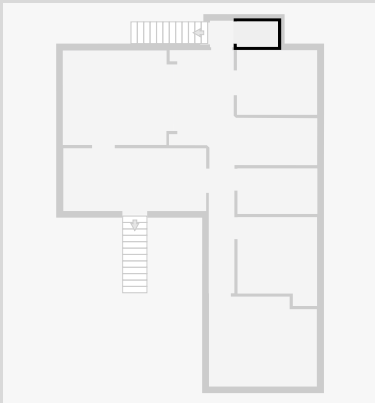

Bedroom

Width: 2.45 m
 Length: 3.04 m
 Area: 7.46 m²
 Perimeter: 10.99 m

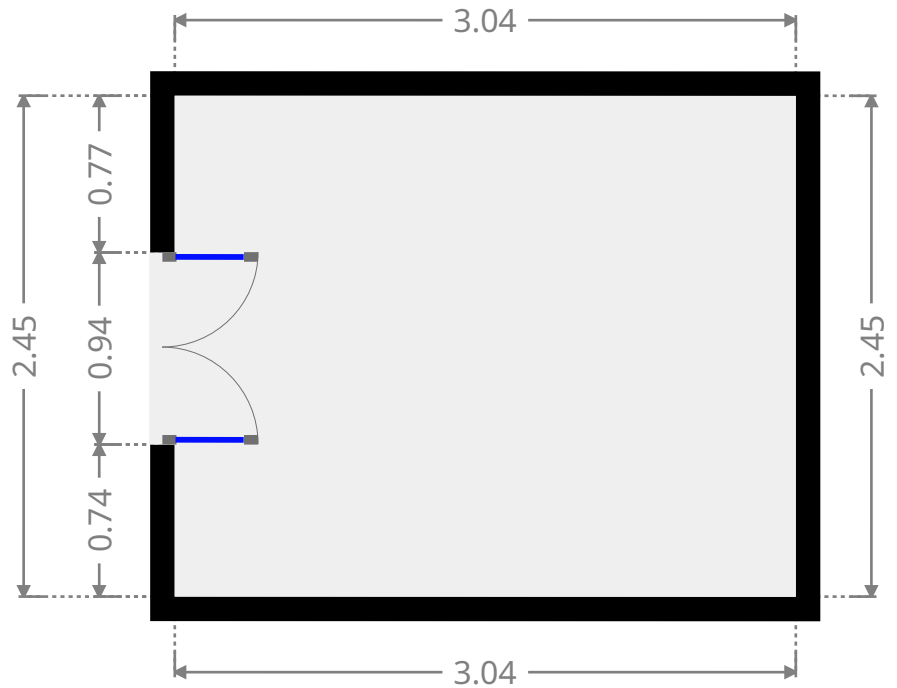
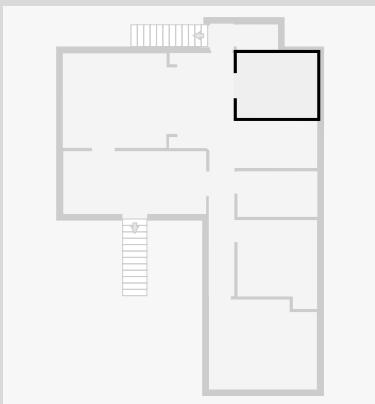

9 Dally Street Wandal

Kitchen

Width: 1.79 m
 Length: 4.09 m
 Area: 6.74 m²
 Perimeter: 11.12 m

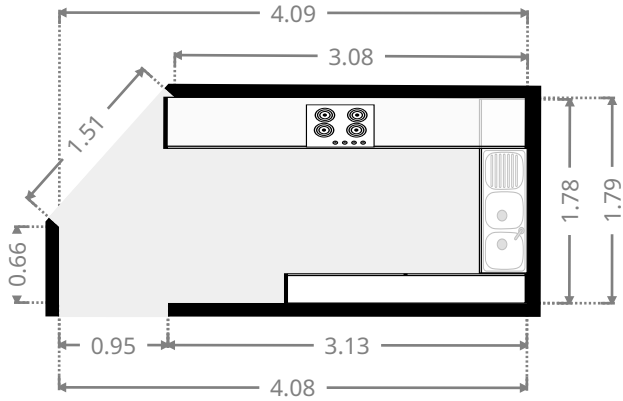
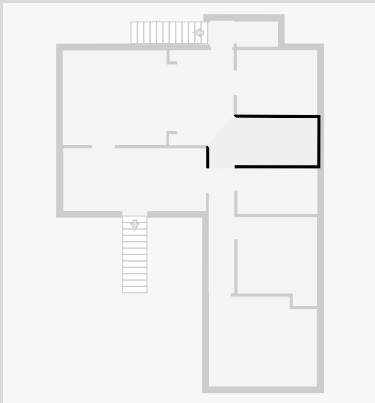

Hall

Width: 0.97 m
 Length: 4.73 m
 Area: 4.58 m²
 Perimeter: 11.39 m

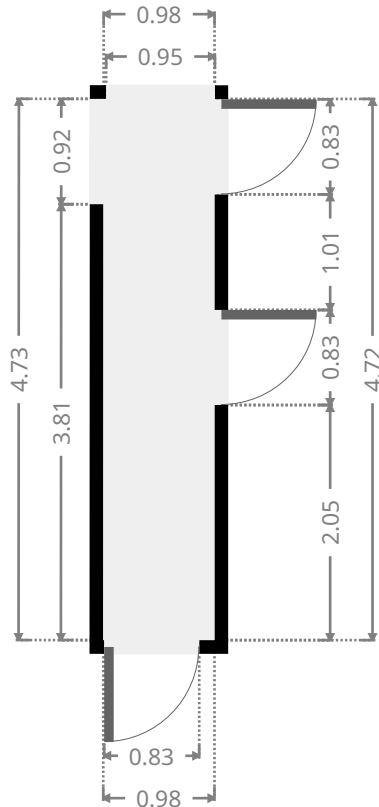
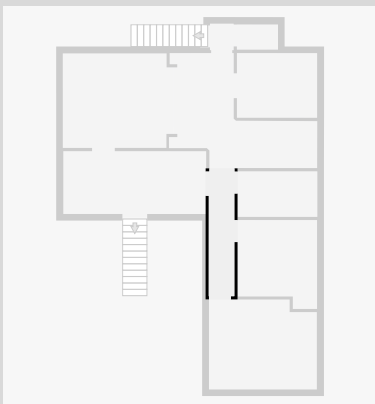

THIS FLOORPLAN IS PROVIDED WITHOUT WARRANTY OF ANY KIND. SENSOPIA DISCLAIMS ANY WARRANTY INCLUDING, WITHOUT LIMITATION, SATISFACTORY QUALITY OR ACCURACY OF DIMENSIONS.

9 Dally Street Wandal

Bathroom

Width: 1.73 m
 Length: 3.03 m
 Area: 5.24 m²
 Perimeter: 9.52 m

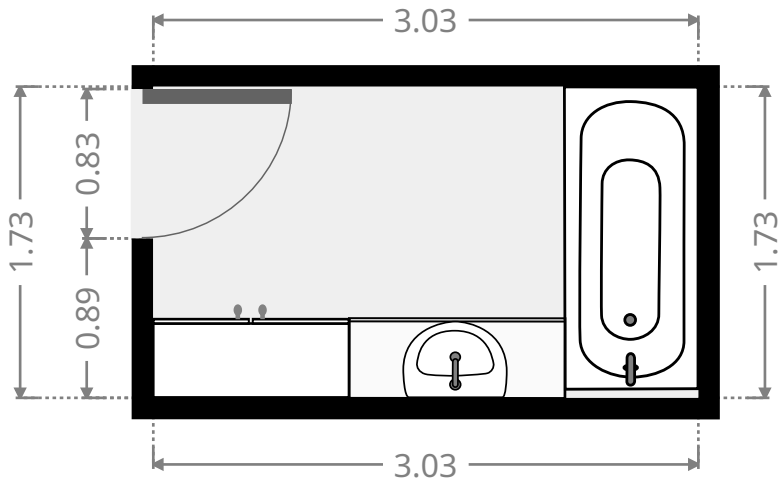
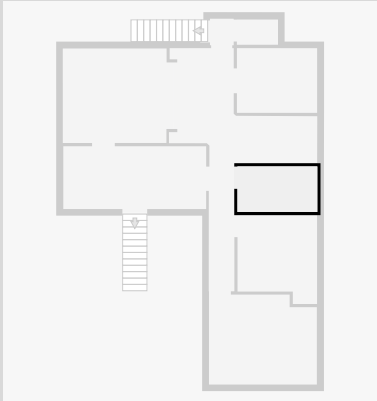

Bedroom

Width: 3.02 m
 Length: 3.37 m
 Area: 9.17 m²
 Perimeter: 12.77 m

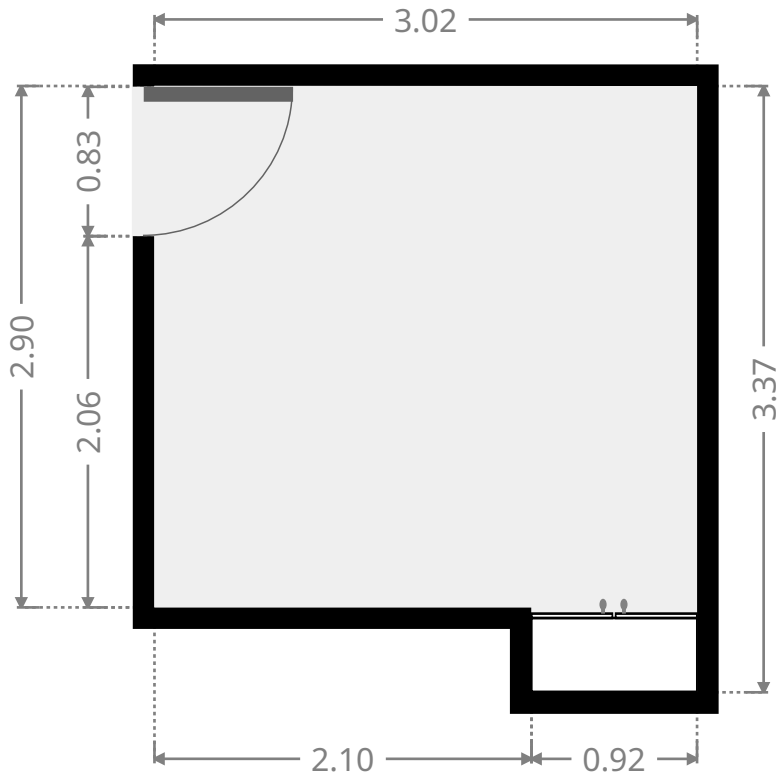
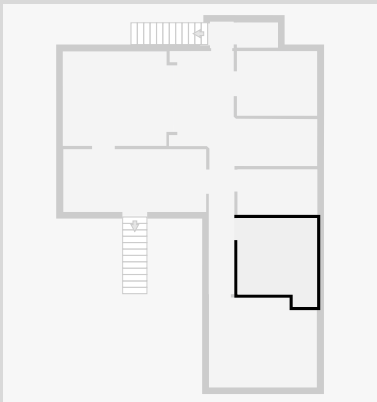

THIS FLOORPLAN IS PROVIDED WITHOUT WARRANTY OF ANY KIND. SENSOPIA DISCLAIMS ANY WARRANTY INCLUDING, WITHOUT LIMITATION, SATISFACTORY QUALITY OR ACCURACY OF DIMENSIONS.

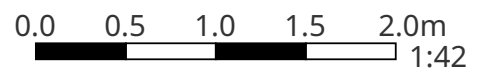

9 Dally Street Wandal

Master Bedroom

Width: 3.41 m
Length: 4.09 m
Area: 13.46 m²
Perimeter: 15.00 m

