

89 Thozet Road

Created on
2021-08-03

Floors
2

▼ Ground Floor

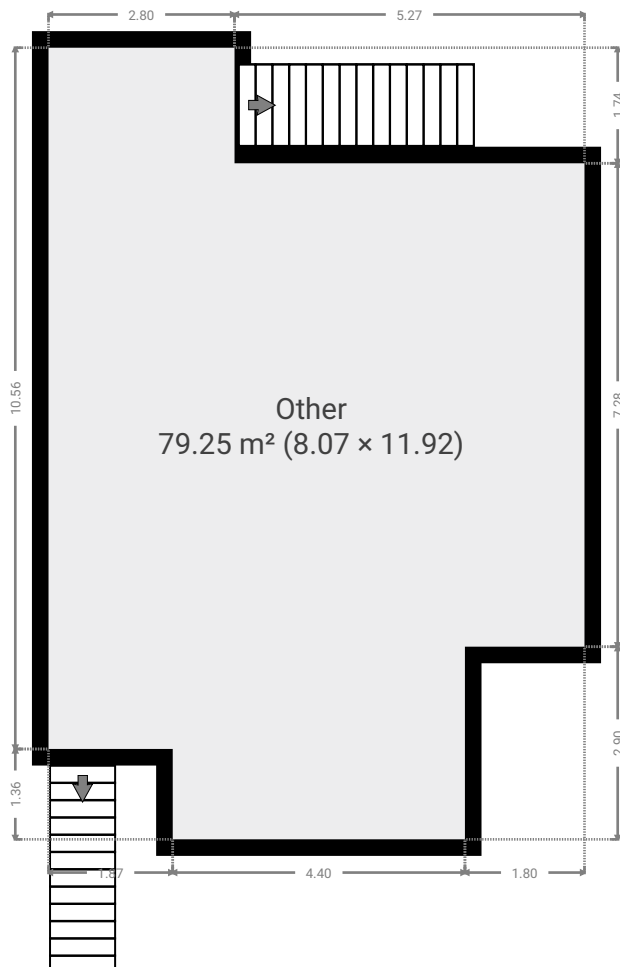
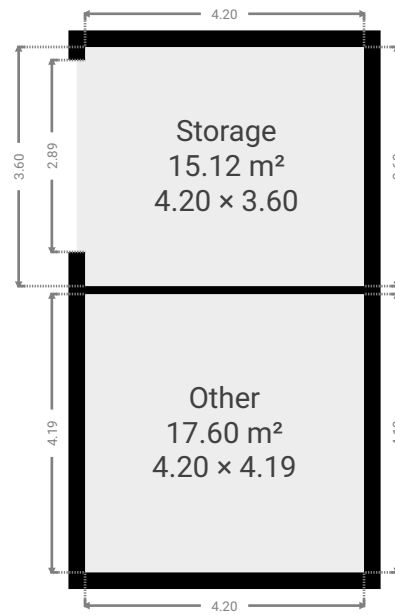

▼ Other
Ground Floor

WIDTH: 8.07 m • LENGTH: 11.92 m
AREA: 79.25 m² • PERIMETER: 39.98 m

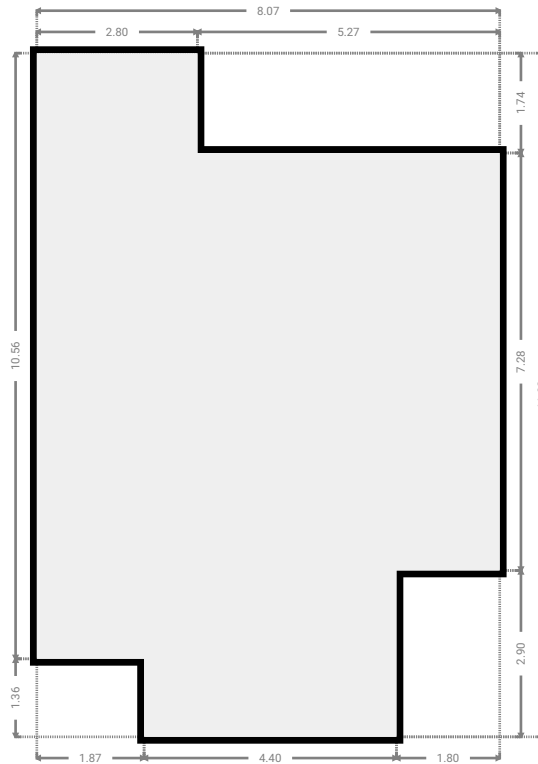
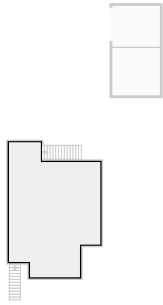

▼ Storage
Ground Floor

WIDTH: 4.18 m • LENGTH: 3.60 m
AREA: 15.12 m² • PERIMETER: 15.60 m

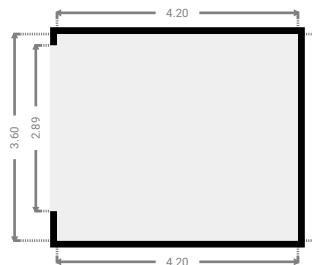
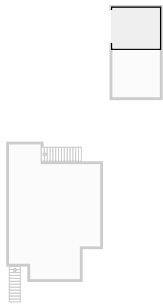

▼ Other
Ground Floor

WIDTH: 4.20 m • LENGTH: 4.19 m
AREA: 17.60 m² • PERIMETER: 16.78 m

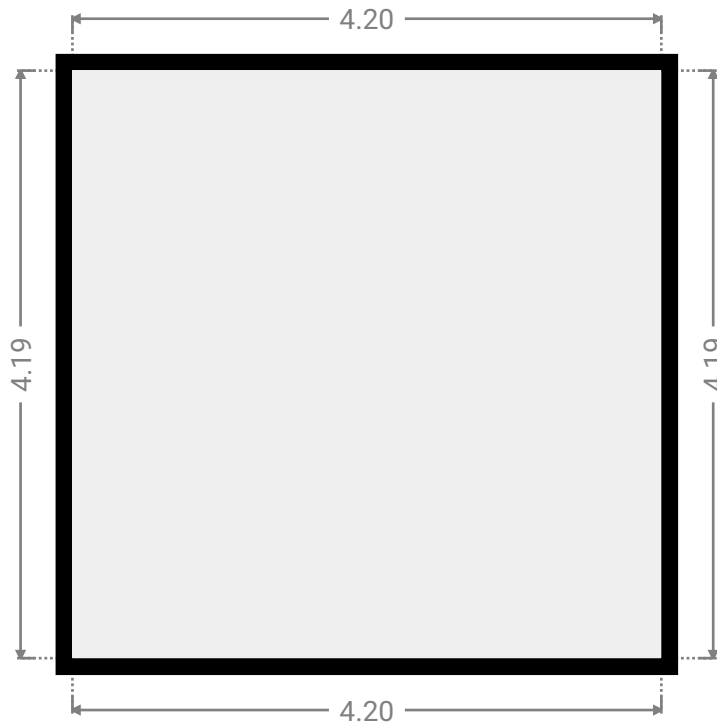
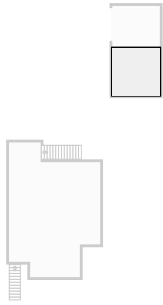

▼ 1st Floor

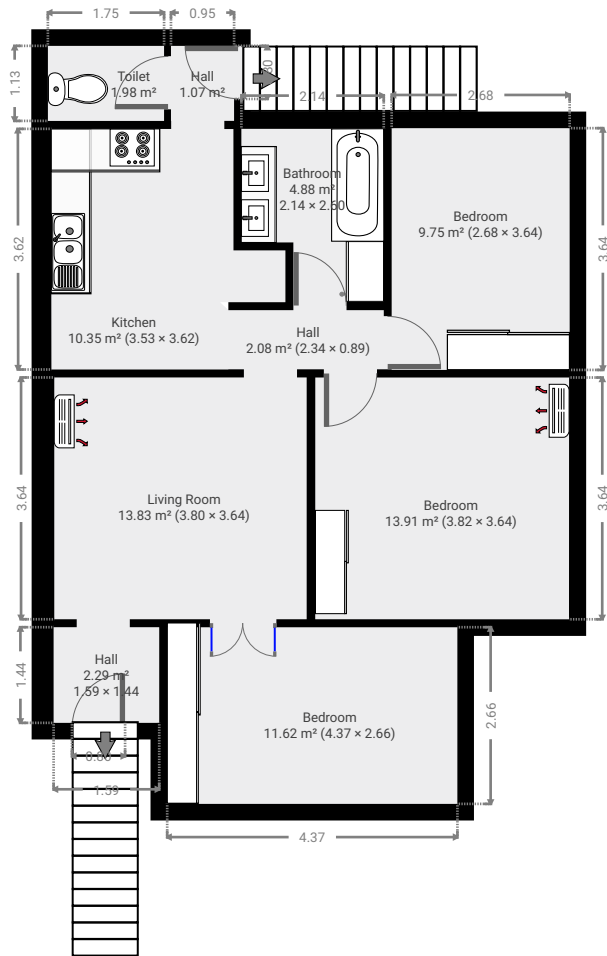

▼ Hall
1st Floor

WIDTH: 1.59 m • LENGTH: 1.44 m
AREA: 2.29 m² • PERIMETER: 6.06 m

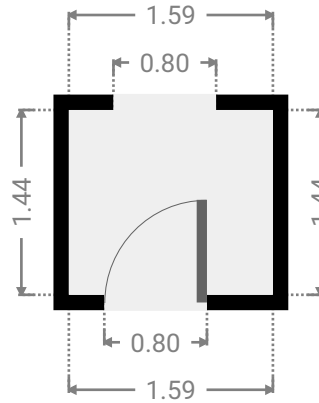
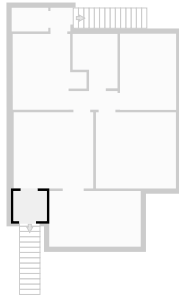

▼ Living Room
1st Floor

WIDTH: 3.80 m • LENGTH: 3.64 m
AREA: 13.83 m² • PERIMETER: 14.88 m

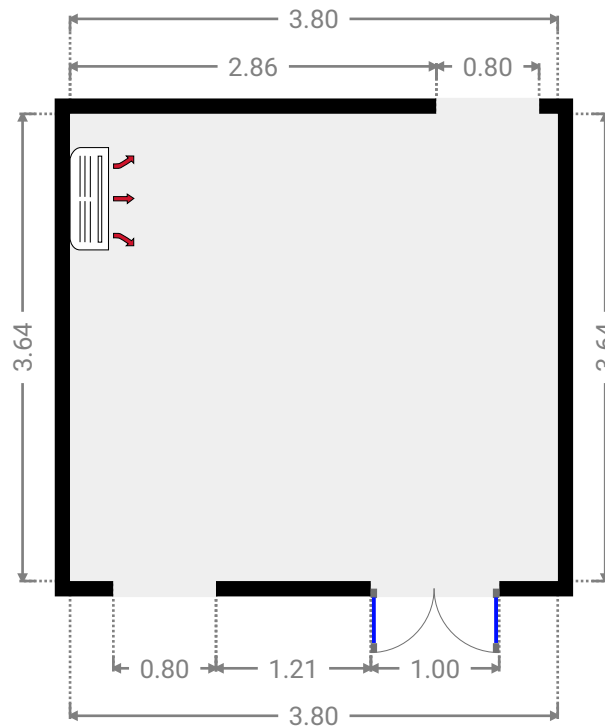
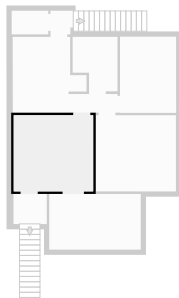

▼ **Bedroom**
1st Floor

WIDTH: 4.37 m • LENGTH: 2.66 m
AREA: 11.62 m² • PERIMETER: 14.06 m

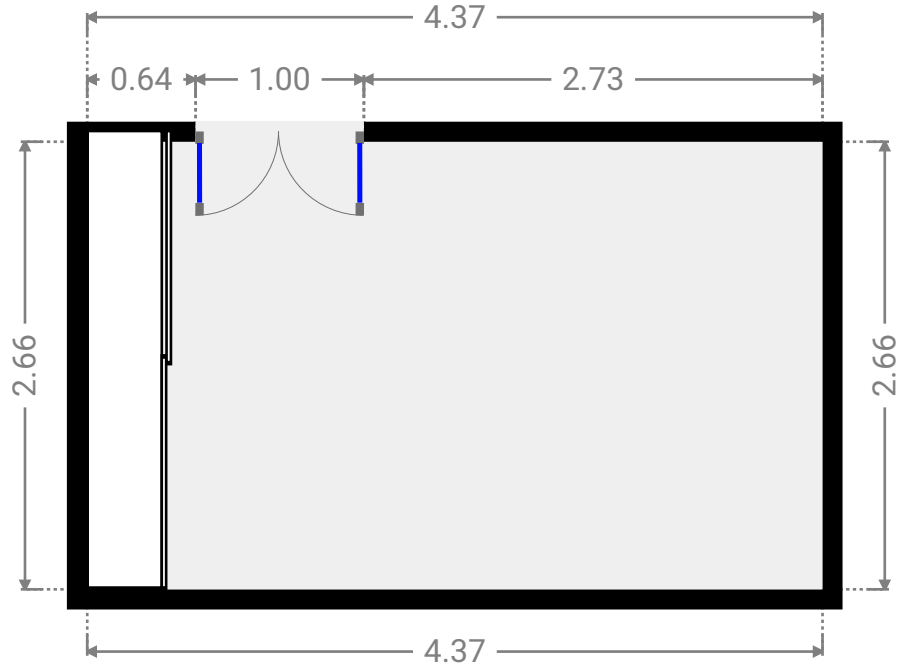
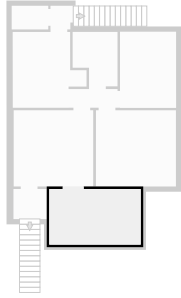

▼ **Hall**
1st Floor

WIDTH: 2.34 m • LENGTH: 0.89 m
AREA: 2.08 m² • PERIMETER: 6.46 m

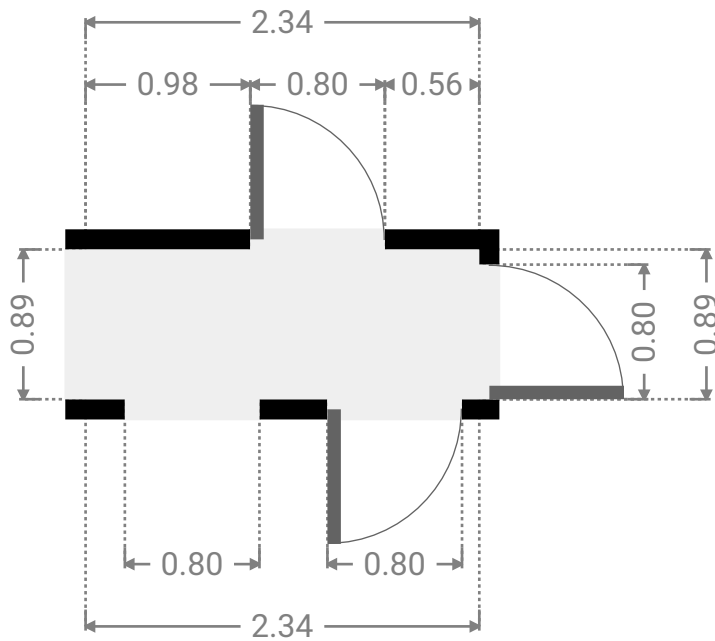
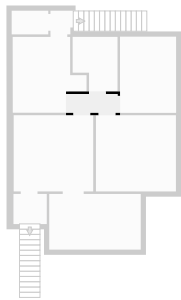

▼ **Bedroom**
1st Floor

WIDTH: 3.82 m • LENGTH: 3.64 m
AREA: 13.91 m² • PERIMETER: 14.92 m

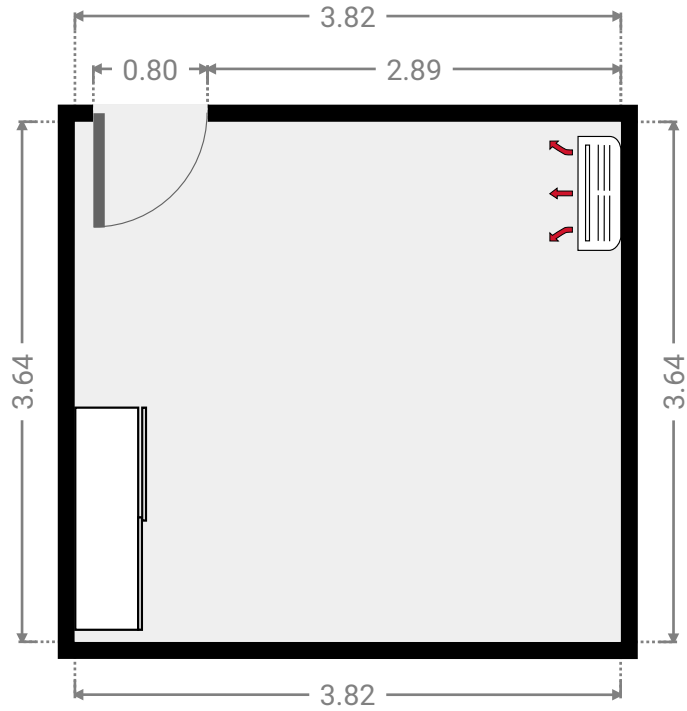
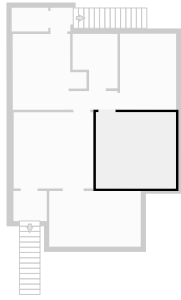

▼ **Bedroom**
1st Floor

WIDTH: 2.68 m • LENGTH: 3.64 m
AREA: 9.75 m² • PERIMETER: 12.64 m

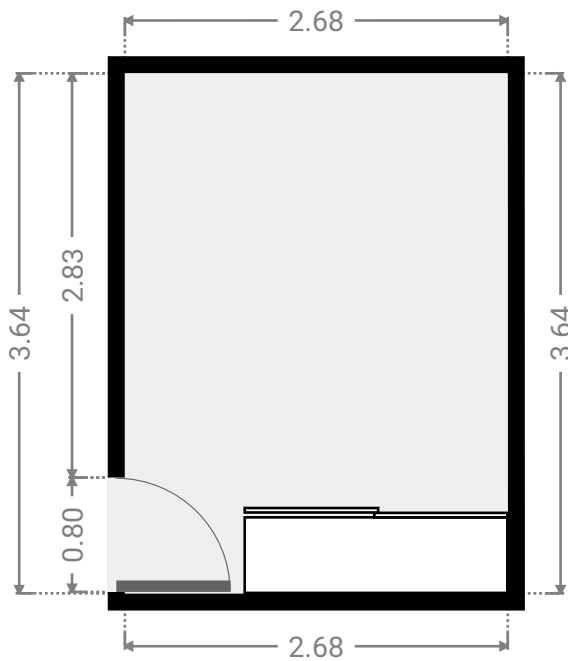
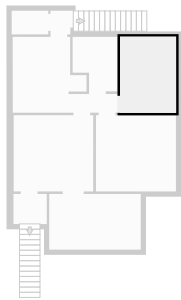

▼ Bathroom
1st Floor

WIDTH: 2.14 m • LENGTH: 2.60 m
AREA: 4.88 m² • PERIMETER: 9.49 m

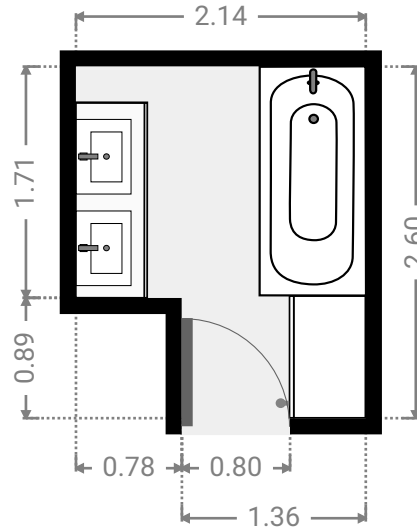
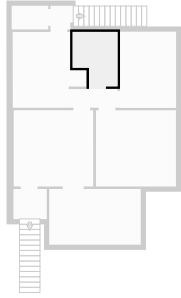

▼ Kitchen
1st Floor

WIDTH: 3.53 m • LENGTH: 3.62 m
AREA: 10.35 m² • PERIMETER: 14.29 m

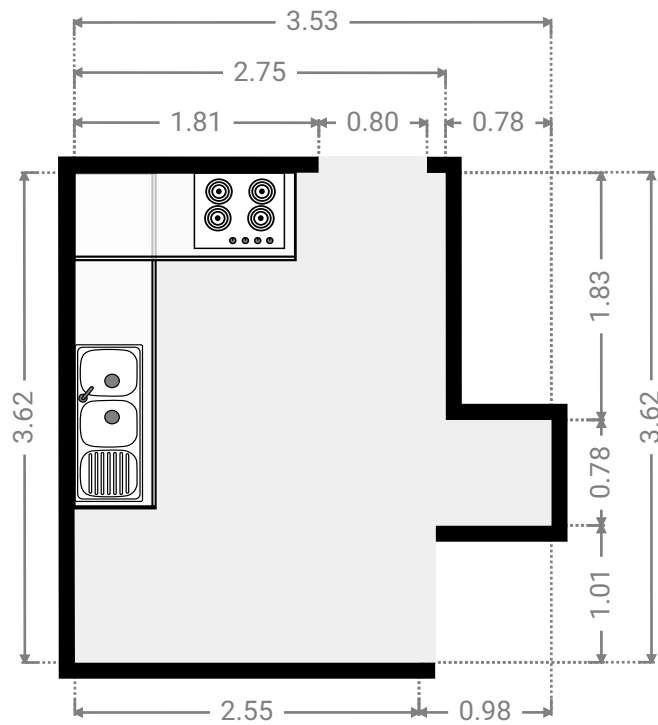
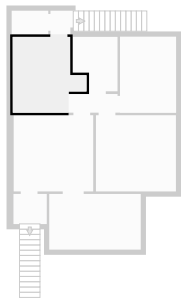

▼ Hall
1st Floor

WIDTH: 0.95 m • LENGTH: 1.13 m
AREA: 1.07 m² • PERIMETER: 4.16 m

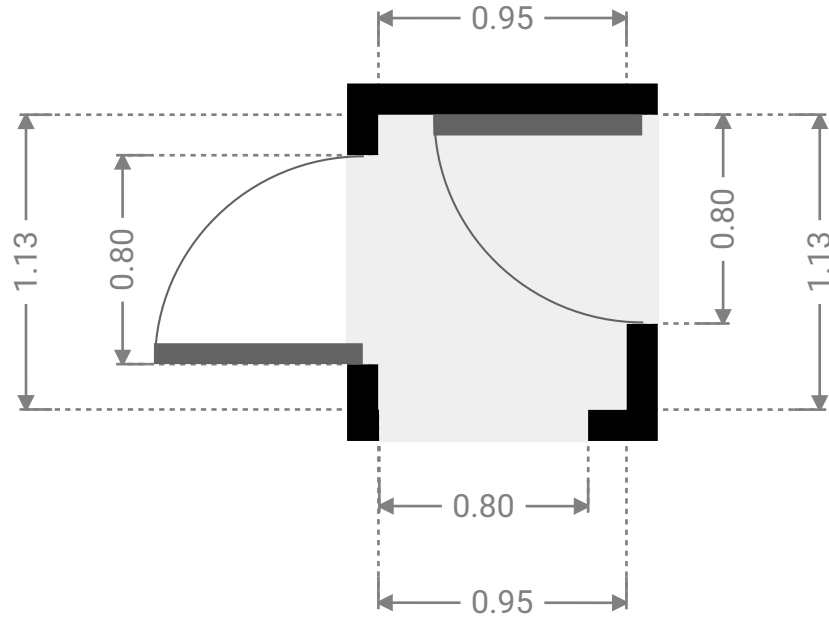
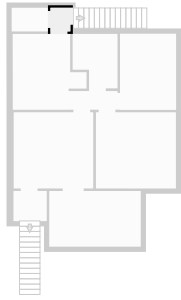

▼ Toilet
1st Floor

WIDTH: 1.75 m • LENGTH: 1.13 m
AREA: 1.98 m² • PERIMETER: 5.76 m

