

# 88A Bennett Street

Created on  
2018-09-27

Floors  
1

▼ Ground Floor

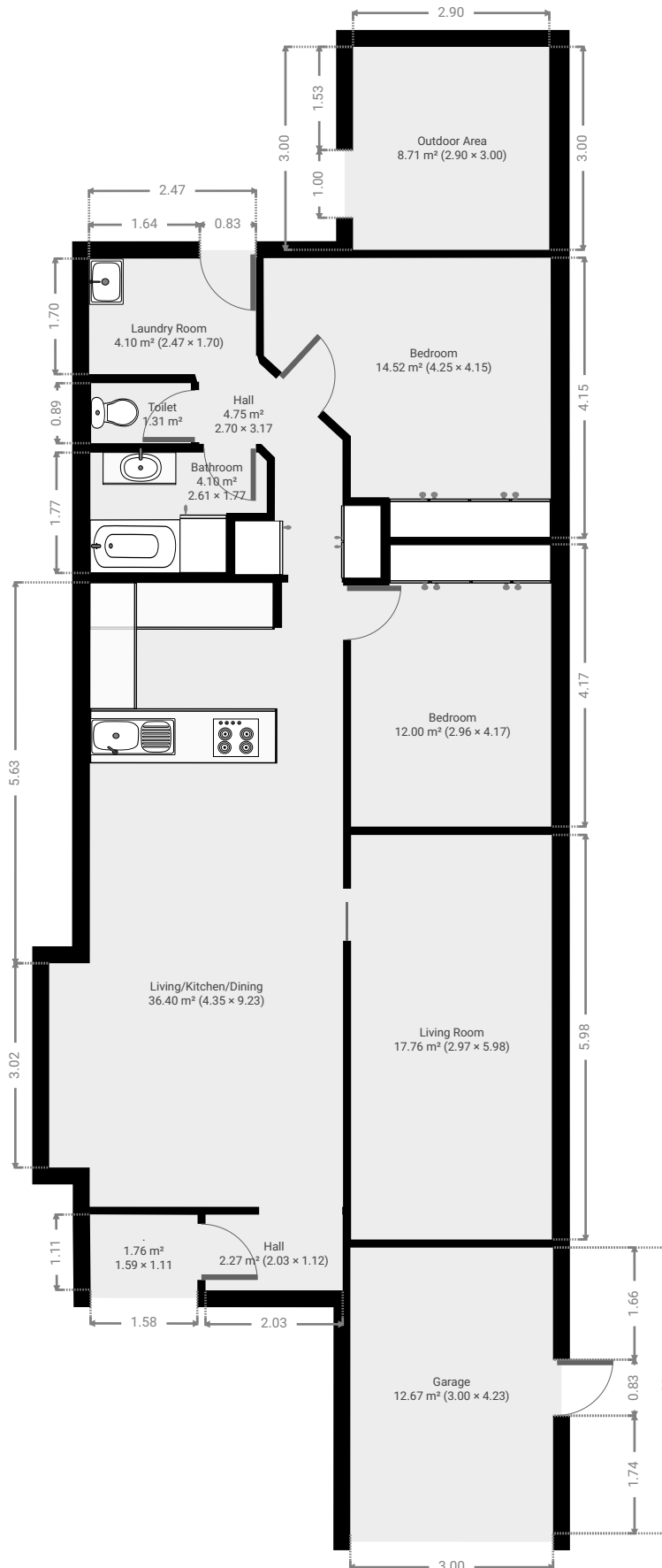

▼ **Hall**  
Ground Floor

WIDTH: 2.03 m • LENGTH: 1.12 m  
AREA: 2.27 m<sup>2</sup> • PERIMETER: 6.30 m

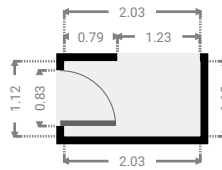
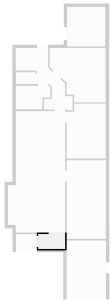

▼ **Living/Kitchen/Dining**  
Ground Floor

WIDTH: 4.35 m • LENGTH: 9.23 m  
AREA: 36.40 m<sup>2</sup> • PERIMETER: 27.15 m

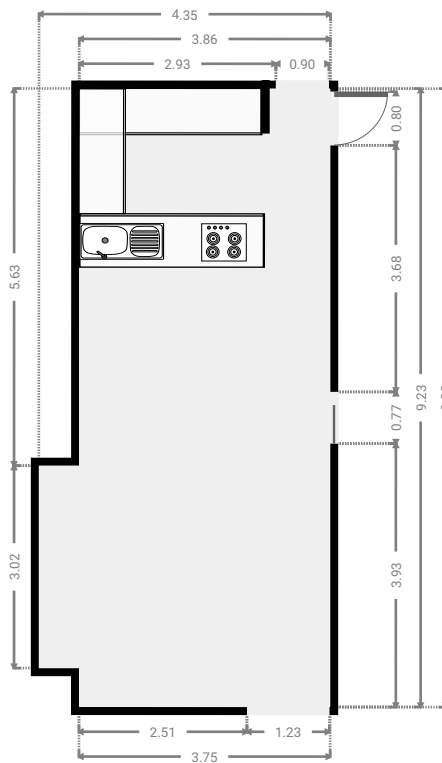
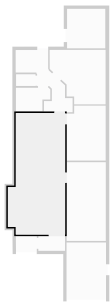

▼ **Living Room**  
Ground Floor

WIDTH: 2.97 m • LENGTH: 5.98 m  
AREA: 17.76 m<sup>2</sup> • PERIMETER: 17.90 m

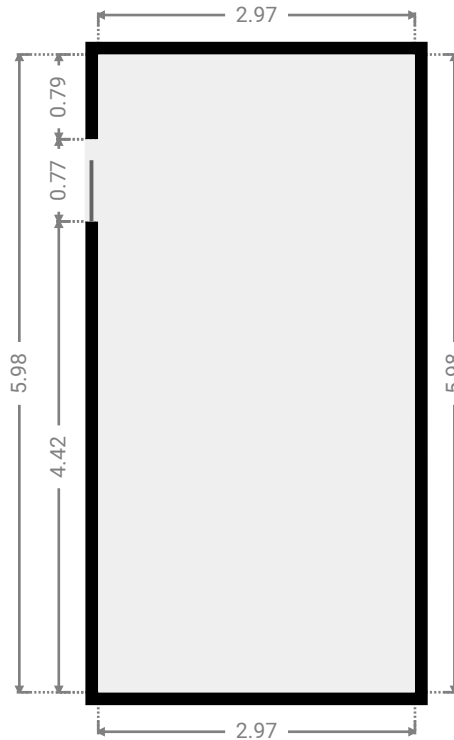
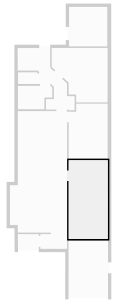

▼ **Bedroom**  
Ground Floor

WIDTH: 2.96 m • LENGTH: 4.17 m  
AREA: 12.00 m<sup>2</sup> • PERIMETER: 14.26 m

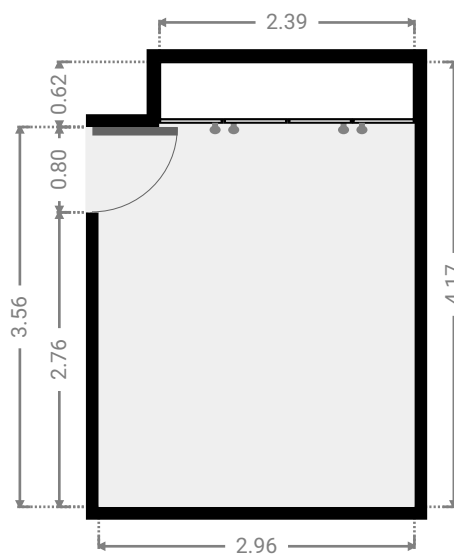
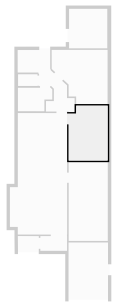

▼ **Bedroom**  
Ground Floor

WIDTH: 4.25 m • LENGTH: 4.15 m  
AREA: 14.52 m<sup>2</sup> • PERIMETER: 16.04 m

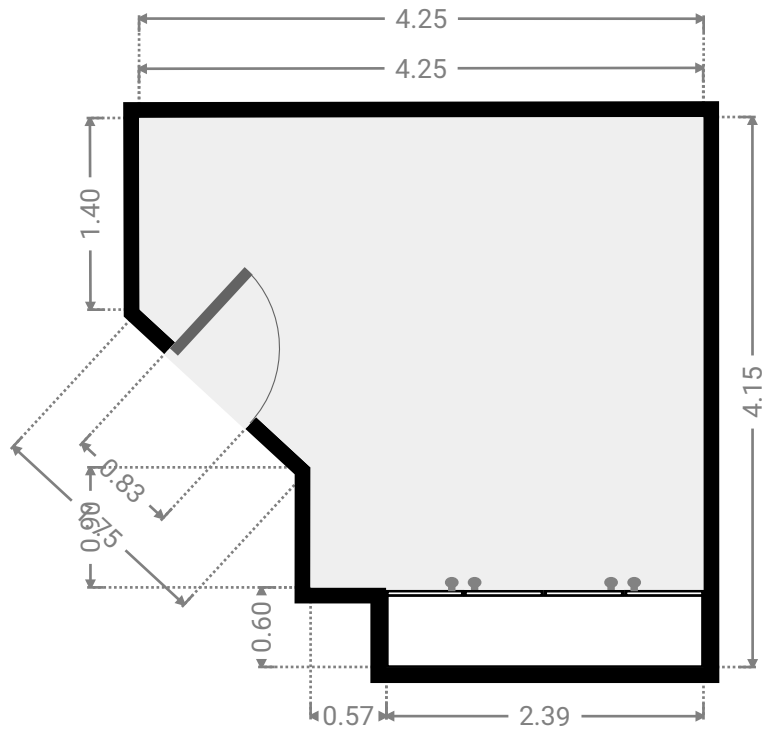
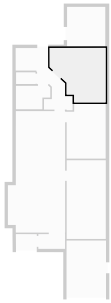

▼ **Laundry Room**  
Ground Floor

WIDTH: 2.47 m • LENGTH: 1.70 m  
AREA: 4.10 m<sup>2</sup> • PERIMETER: 8.13 m

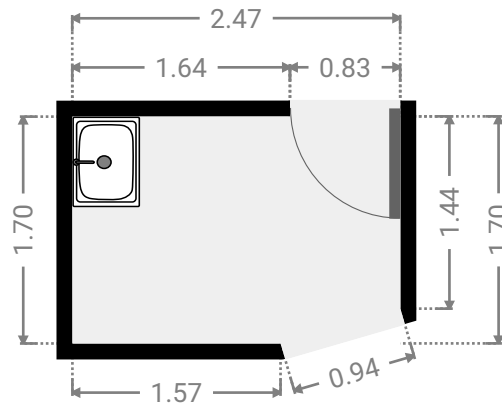
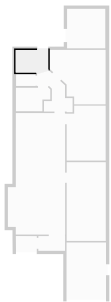

▼ Bathroom  
Ground Floor

WIDTH: 2.61 m • LENGTH: 1.77 m  
AREA: 4.10 m<sup>2</sup> • PERIMETER: 8.71 m

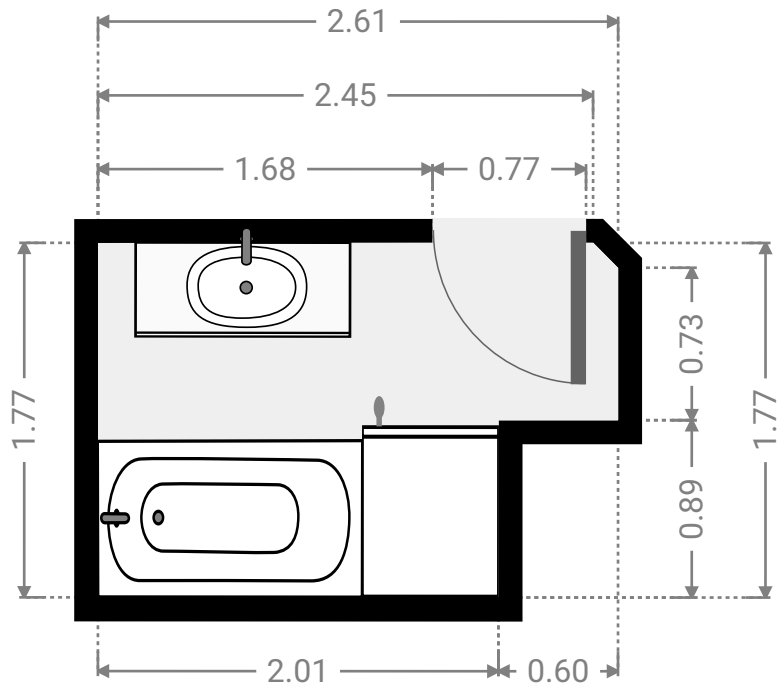
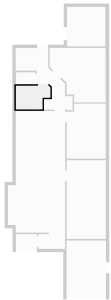

▼ Toilet  
Ground Floor

WIDTH: 1.48 m • LENGTH: 0.88 m  
AREA: 1.31 m<sup>2</sup> • PERIMETER: 4.72 m

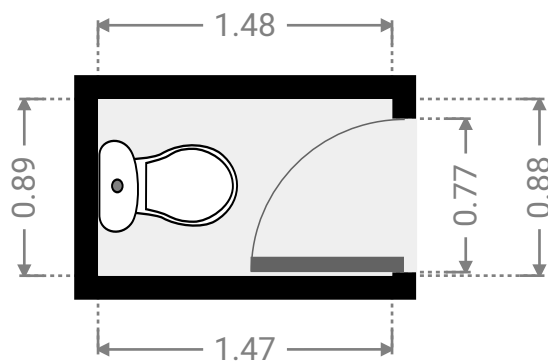
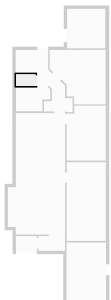

▼ Hall  
Ground Floor

WIDTH: 2.70 m • LENGTH: 3.17 m  
AREA: 4.75 m<sup>2</sup> • PERIMETER: 11.90 m

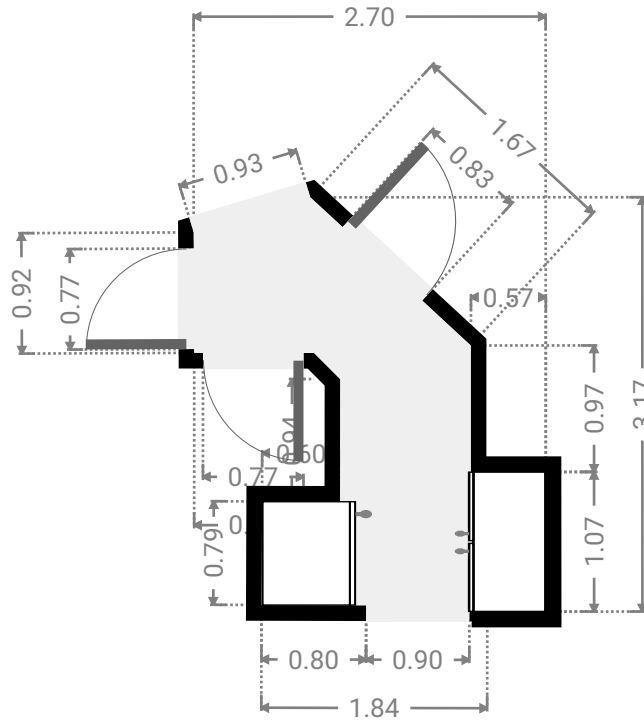
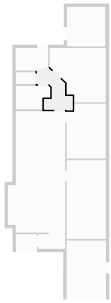

▼ .  
Ground Floor

WIDTH: 1.59 m • LENGTH: 1.11 m  
AREA: 1.76 m<sup>2</sup> • PERIMETER: 5.39 m

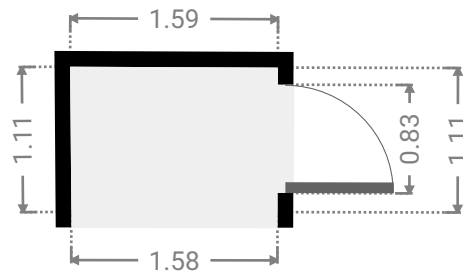
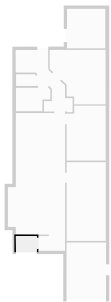

▼ **Garage**  
Ground Floor

WIDTH: 3.00 m • LENGTH: 4.23 m  
AREA: 12.67 m<sup>2</sup> • PERIMETER: 14.45 m

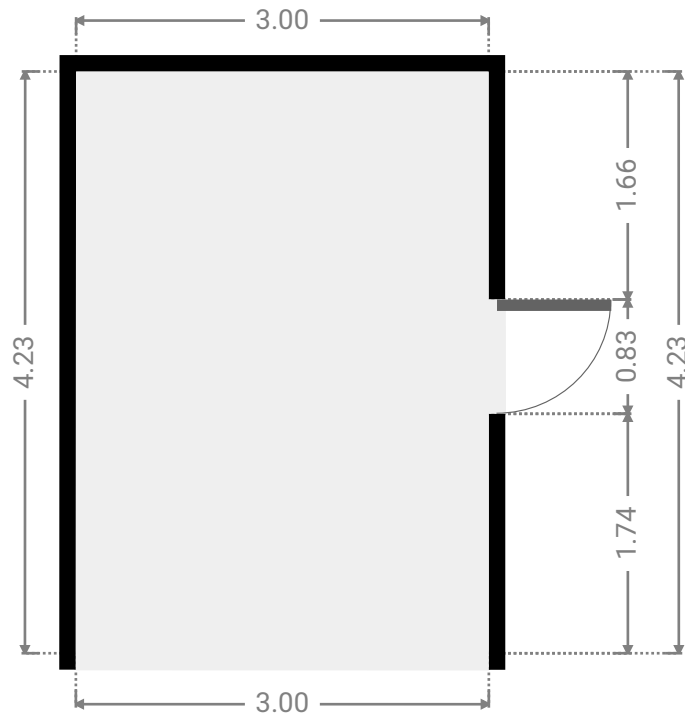
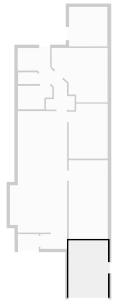

▼ **Outdoor Area**  
Ground Floor

WIDTH: 2.90 m • LENGTH: 3.00 m  
AREA: 8.71 m<sup>2</sup> • PERIMETER: 11.81 m

