

# 85 Simpson Street

## Ground Floor



THIS FLOORPLAN IS PROVIDED WITHOUT WARRANTY OF ANY KIND. SENSOPIA DISCLAIMS ANY WARRANTY INCLUDING, WITHOUT LIMITATION, SATISFACTORY QUALITY OR ACCURACY OF DIMENSIONS.

# 85 Simpson Street

## Living Room

Width: 7.06 m  
 Length: 8.41 m  
 Area: 53.30 m<sup>2</sup>  
 Perimeter: 30.95 m

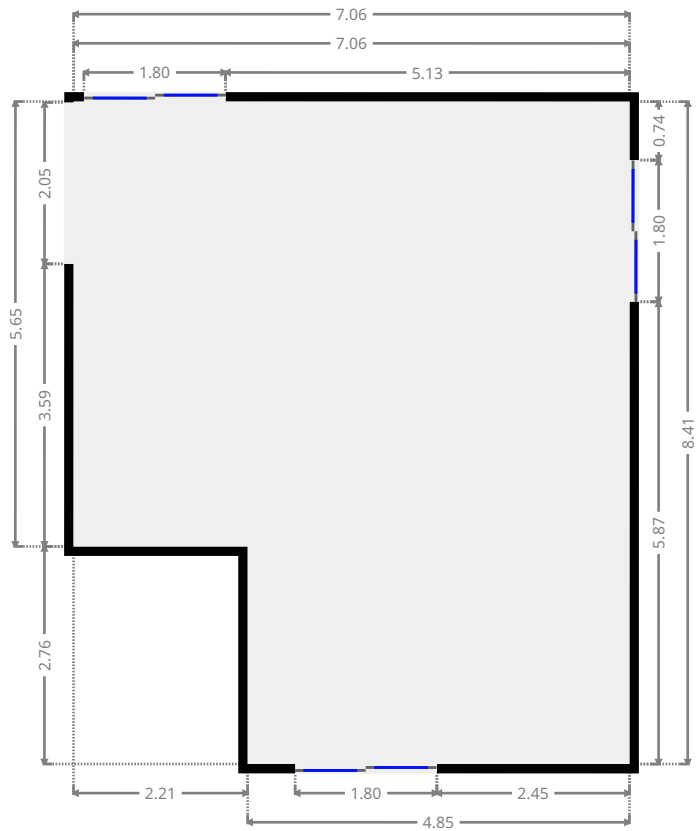
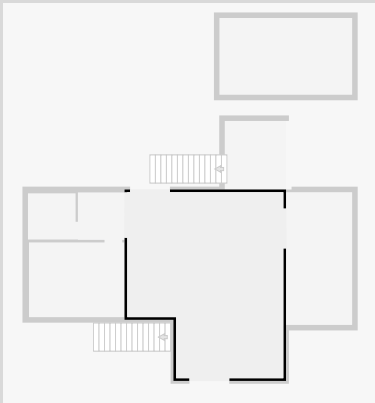

## Laundry Room

Width: 2.12 m  
 Length: 2.15 m  
 Area: 4.55 m<sup>2</sup>  
 Perimeter: 8.54 m

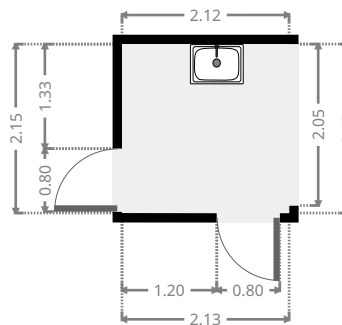
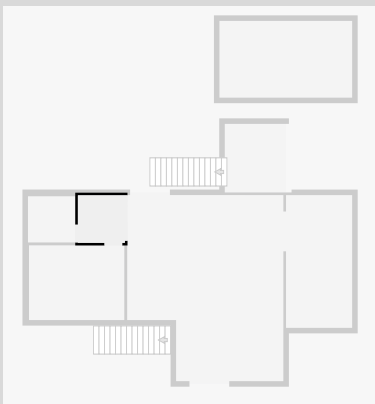

# 85 Simpson Street

## Bathroom

Width: 2.09 m  
Length: 2.15 m  
Area: 4.49 m<sup>2</sup>  
Perimeter: 8.48 m

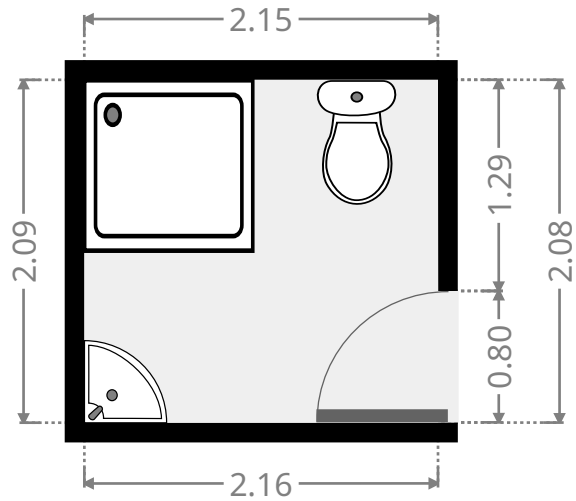
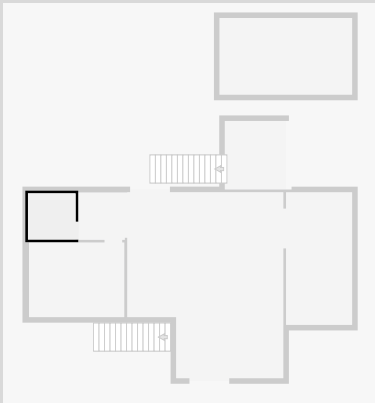

## Bedroom

Width: 3.38 m  
Length: 4.31 m  
Area: 14.55 m<sup>2</sup>  
Perimeter: 15.37 m

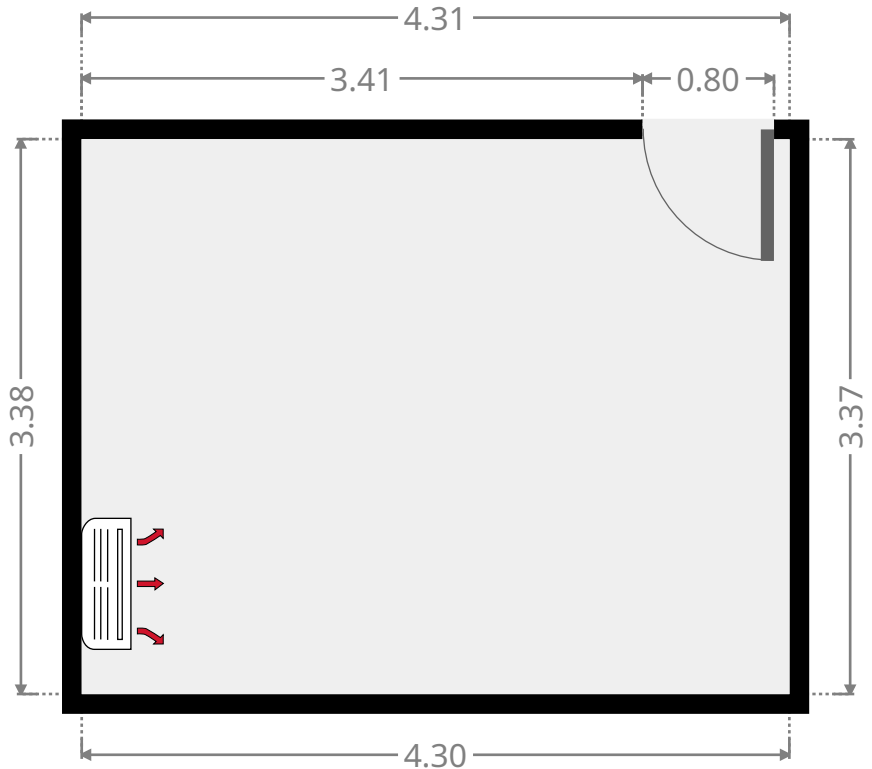
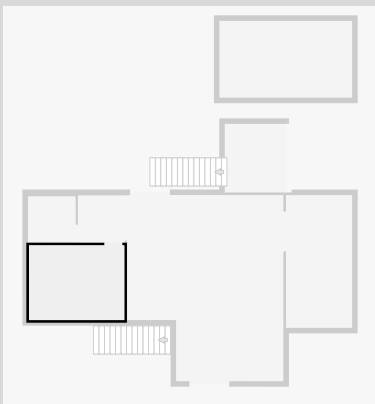

# 85 Simpson Street

## Entertainment Area

Width: 2.99 m  
 Length: 6.00 m  
 Area: 17.94 m<sup>2</sup>  
 Perimeter: 17.98 m

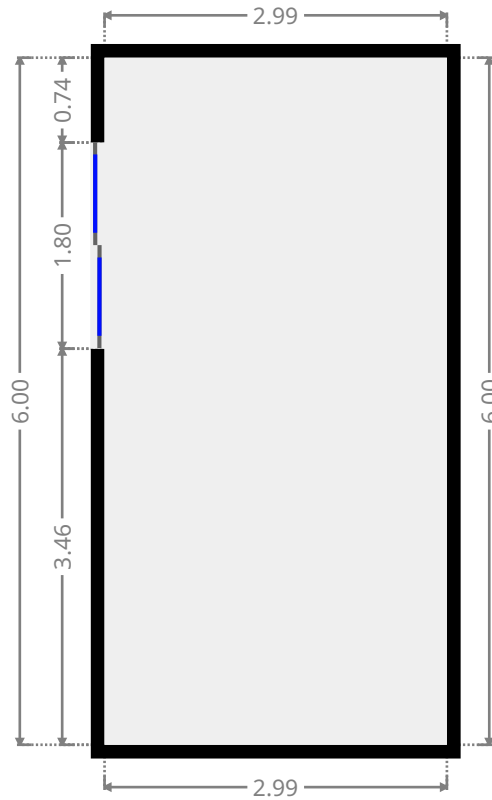
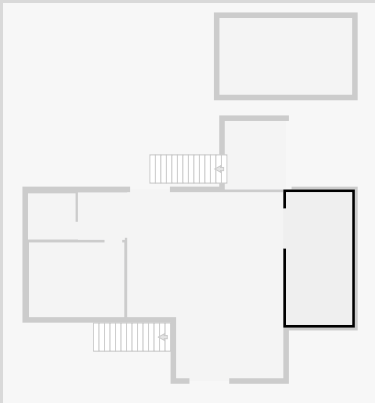

Width: 2.65 m  
 Length: 3.10 m  
 Area: 8.21 m<sup>2</sup>  
 Perimeter: 11.50 m

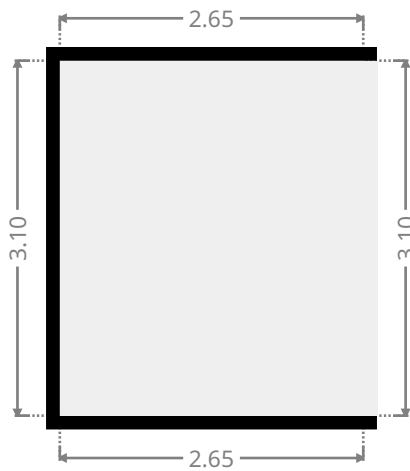
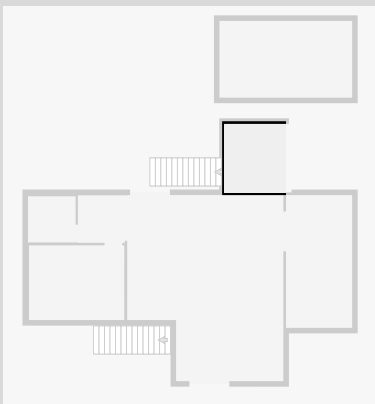

# 85 Simpson Street

## Carport

Width: 3.47 m  
Length: 6.00 m  
Area: 20.82 m<sup>2</sup>  
Perimeter: 18.94 m

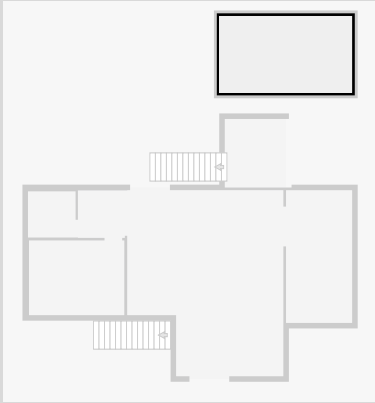

# 85 Simpson Street

## 1st Floor



THIS FLOORPLAN IS PROVIDED WITHOUT WARRANTY OF ANY KIND. SENSOPIA DISCLAIMS ANY WARRANTY INCLUDING, WITHOUT LIMITATION, SATISFACTORY QUALITY OR ACCURACY OF DIMENSIONS.



# 85 Simpson Street

## Living Room

Width: 4.91 m  
 Length: 5.08 m  
 Area: 23.27 m<sup>2</sup>  
 Perimeter: 19.98 m

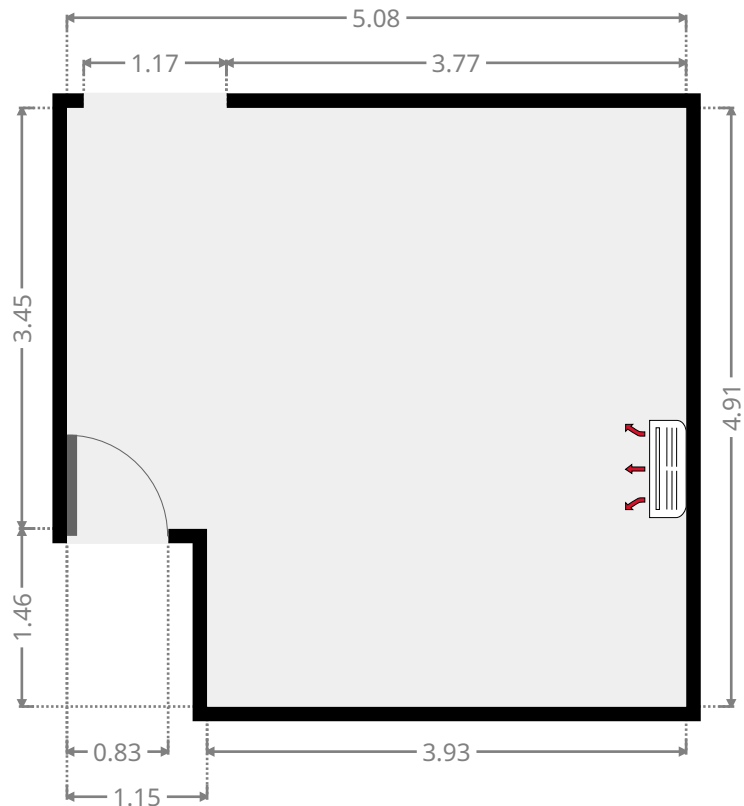
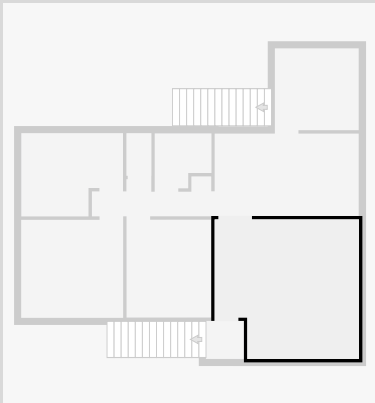

## Kitchen

Width: 2.90 m  
 Length: 5.07 m  
 Area: 14.70 m<sup>2</sup>  
 Perimeter: 15.94 m

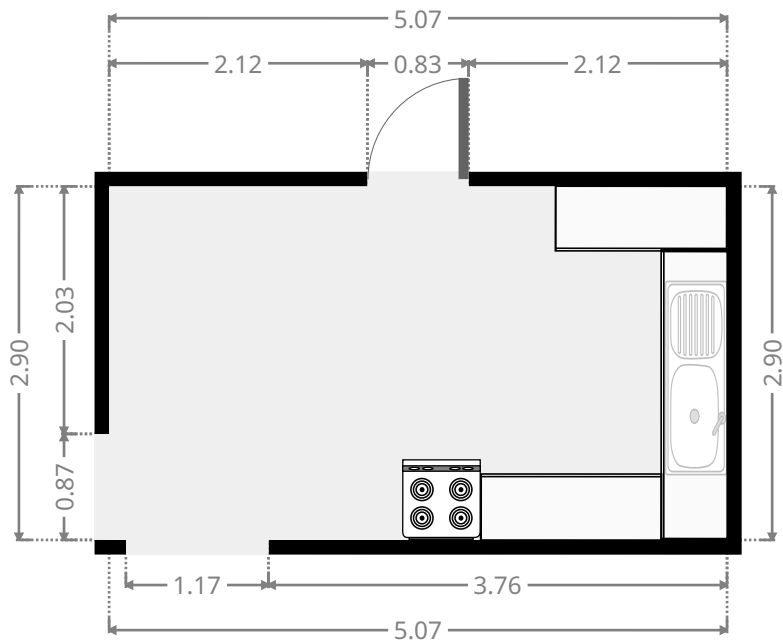
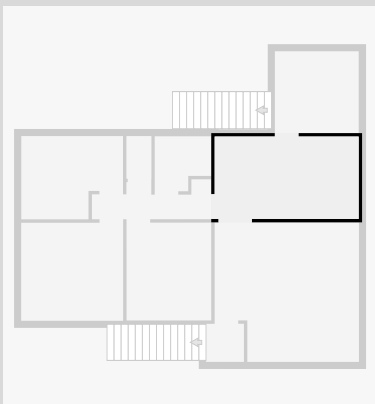

# 85 Simpson Street

## Hall

Width: 1.41 m  
 Length: 4.20 m  
 Area: 4.41 m<sup>2</sup>  
 Perimeter: 12.09 m

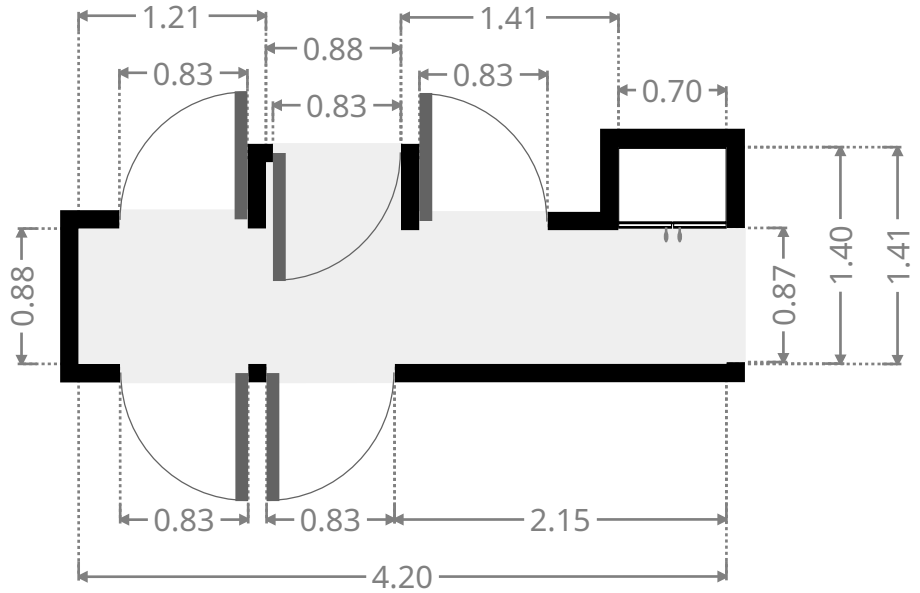
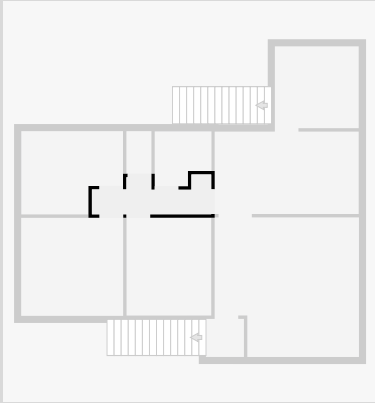

## Bedroom

Width: 2.98 m  
 Length: 3.44 m  
 Area: 10.26 m<sup>2</sup>  
 Perimeter: 12.85 m

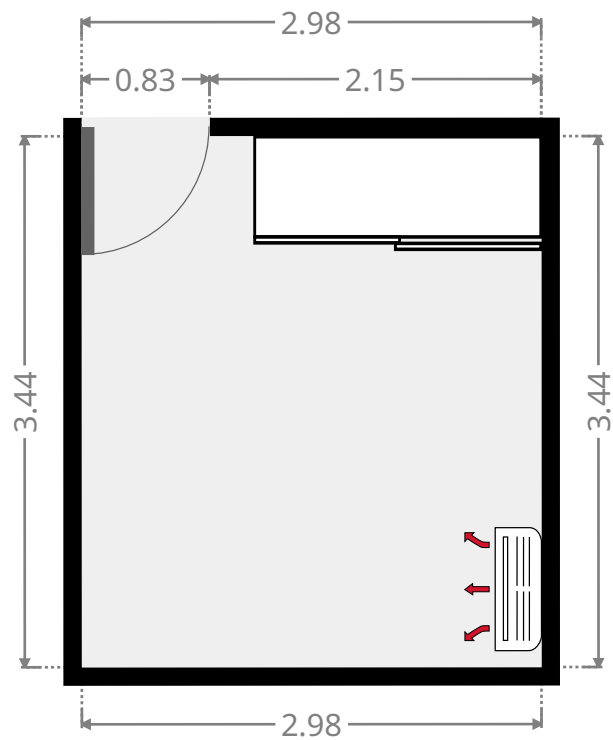
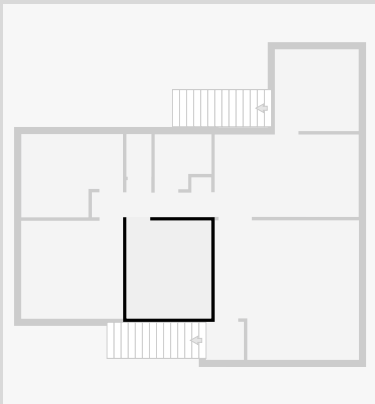

THIS FLOORPLAN IS PROVIDED WITHOUT WARRANTY OF ANY KIND. SENSOPIA DISCLAIMS ANY WARRANTY INCLUDING, WITHOUT LIMITATION, SATISFACTORY QUALITY OR ACCURACY OF DIMENSIONS.

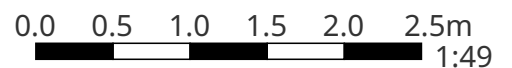



# 85 Simpson Street

## Master Bedroom

Width: 3.45 m  
 Length: 3.59 m  
 Area: 12.38 m<sup>2</sup>  
 Perimeter: 14.08 m

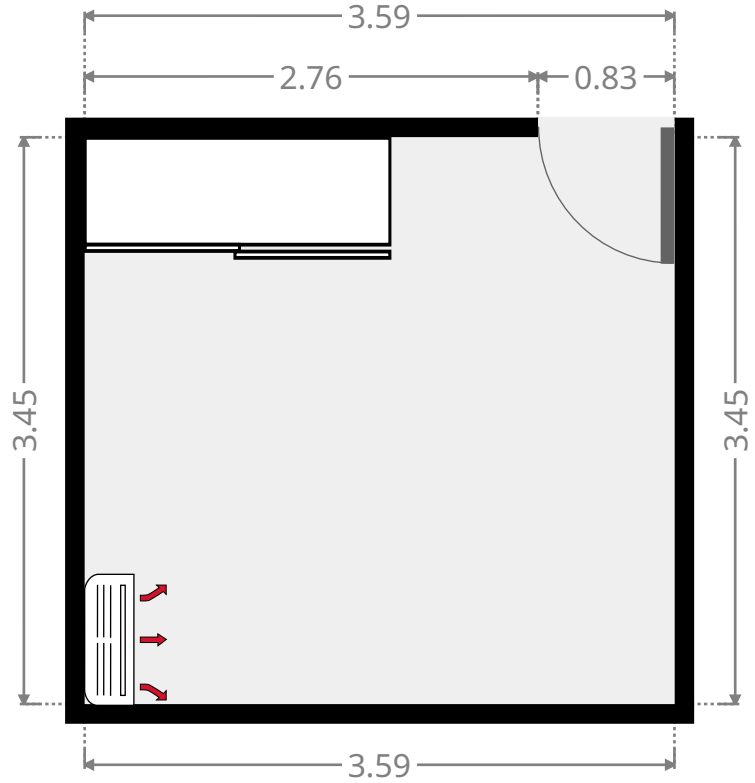
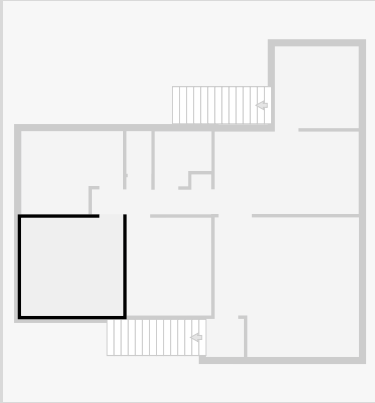

## Bedroom

Width: 2.93 m  
 Length: 3.58 m  
 Area: 9.27 m<sup>2</sup>  
 Perimeter: 13.02 m

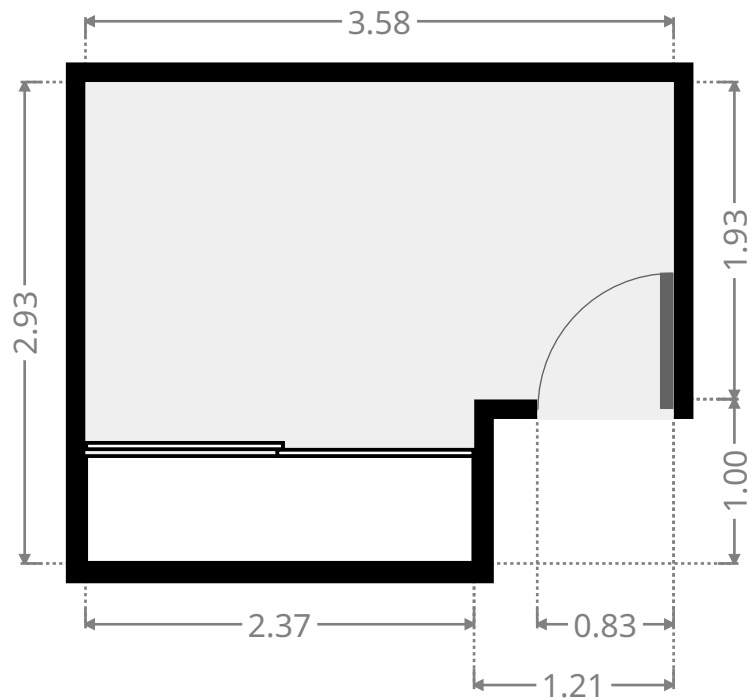
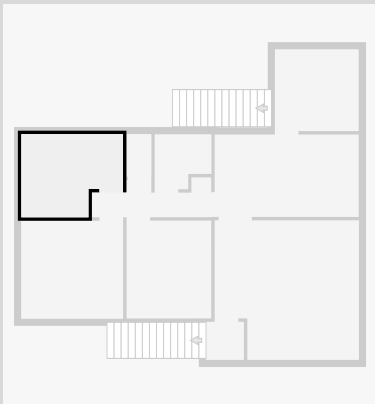

# 85 Simpson Street

## Toilet / Half Bath

Width: 0.88 m  
 Length: 1.50 m  
 Area: 1.32 m<sup>2</sup>  
 Perimeter: 4.76 m

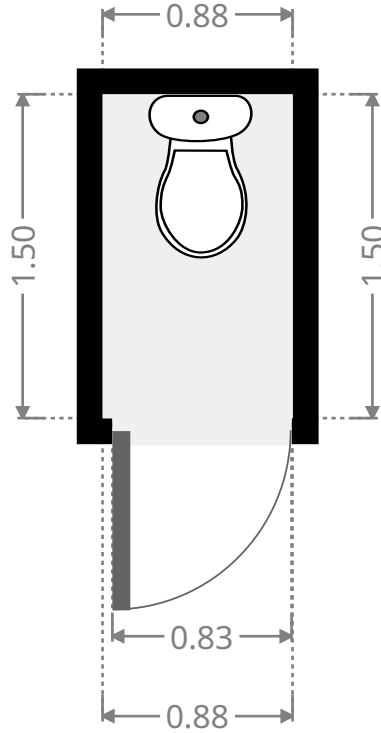
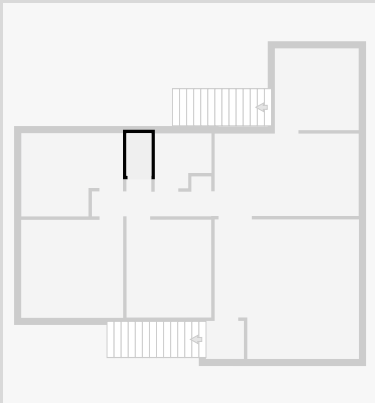

## Bathroom

Width: 1.93 m  
 Length: 2.00 m  
 Area: 3.42 m<sup>2</sup>  
 Perimeter: 7.86 m

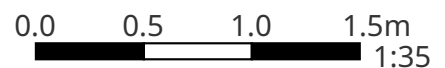
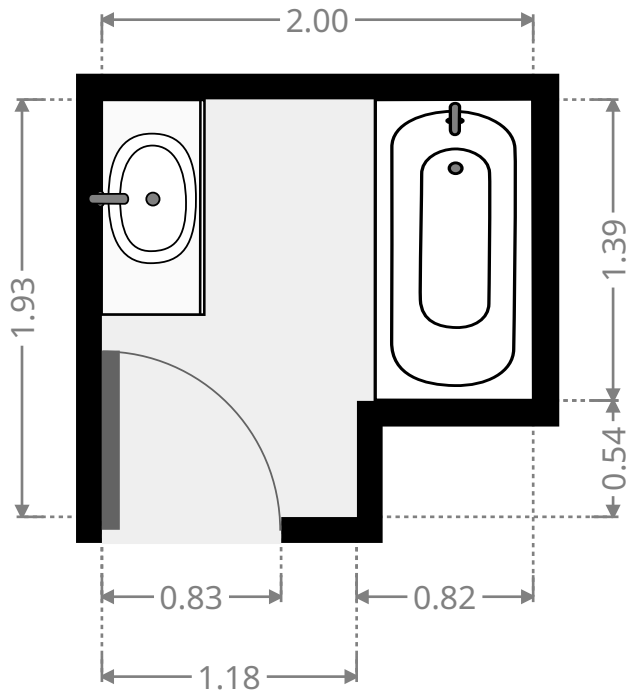
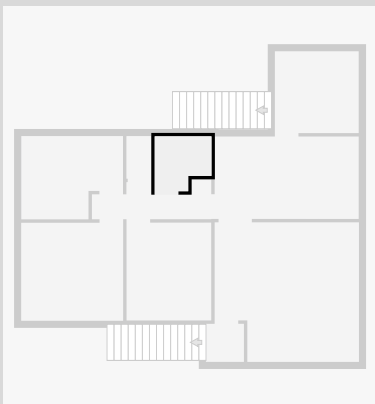

THIS FLOORPLAN IS PROVIDED WITHOUT WARRANTY OF ANY KIND. SENSOPIA DISCLAIMS ANY WARRANTY INCLUDING, WITHOUT LIMITATION, SATISFACTORY QUALITY OR ACCURACY OF DIMENSIONS.

# 85 Simpson Street

## Deck

Width: 2.88 m  
 Length: 2.95 m  
 Area: 8.50 m<sup>2</sup>  
 Perimeter: 11.66 m

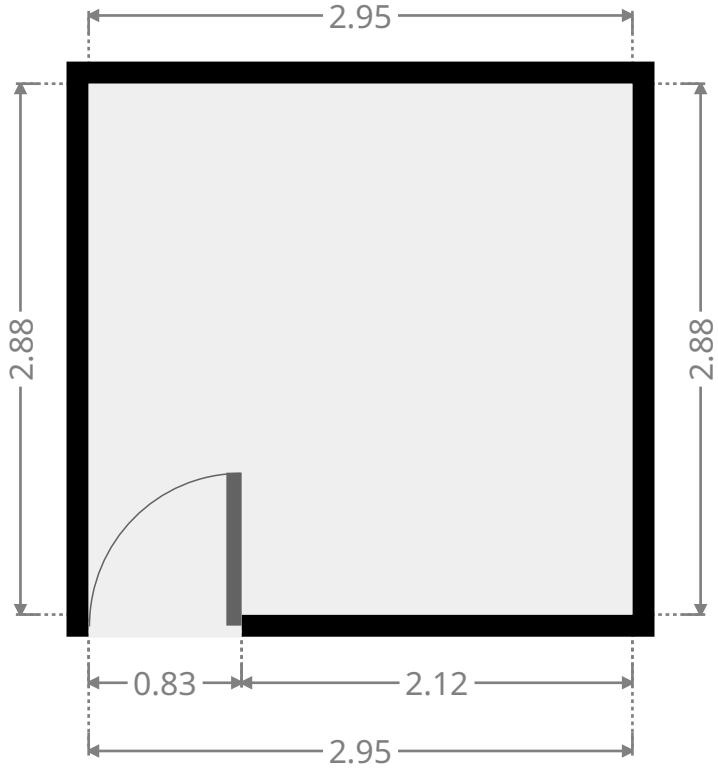
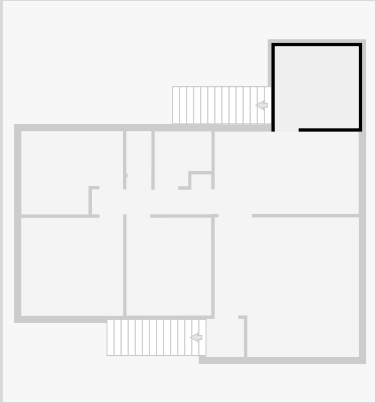

Width: 1.34 m  
 Length: 1.34 m  
 Area: 1.79 m<sup>2</sup>  
 Perimeter: 5.35 m

