

84 Dean Street

SUBMITTED BY

Ray White Rockhampton Casey
stockers@cqoz.com

CREATED ON

2021-11-25

Floors

2

▼ Ground Floor

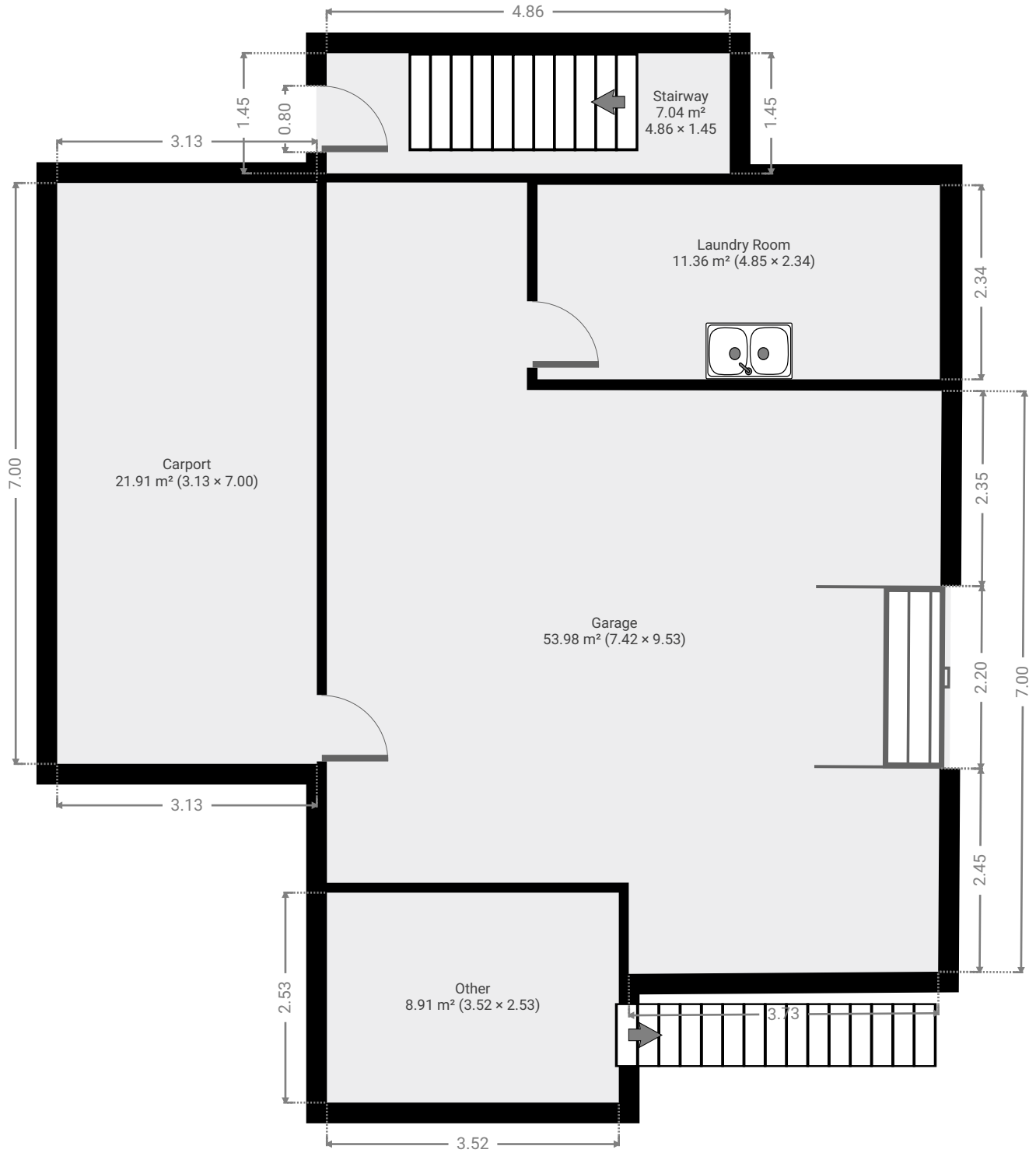

▼ **Stairway**
Ground Floor

WIDTH: 4.86 m • LENGTH: 1.45 m
AREA: 7.04 m² • PERIMETER: 12.62 m

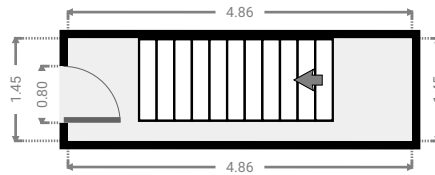
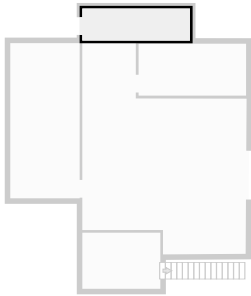

▼ **Garage**
Ground Floor

WIDTH: 7.47 m • LENGTH: 9.54 m
AREA: 53.98 m² • PERIMETER: 33.83 m

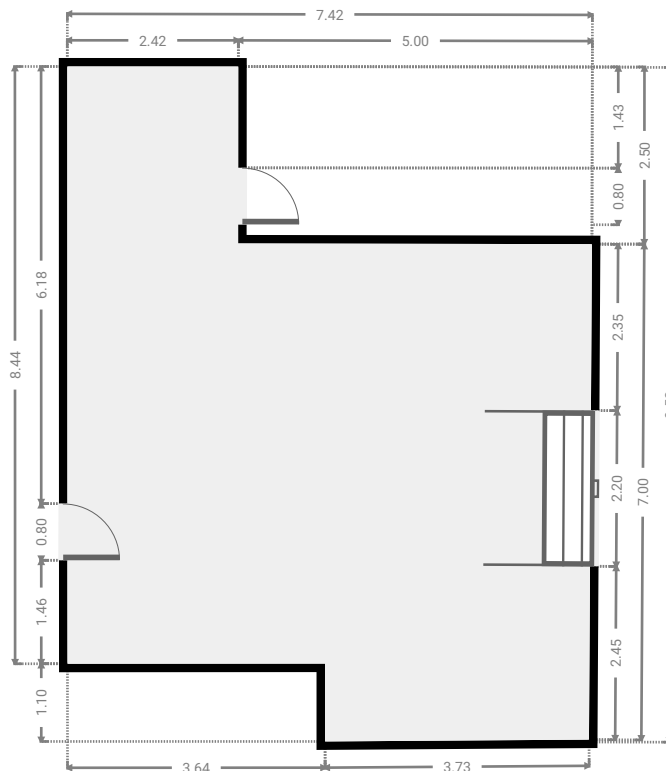
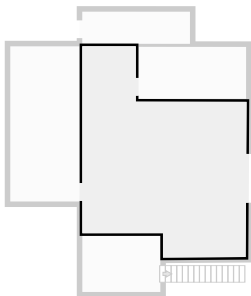

▼ **Laundry Room**
Ground Floor

WIDTH: 4.85 m • LENGTH: 2.34 m
AREA: 11.36 m² • PERIMETER: 14.38 m

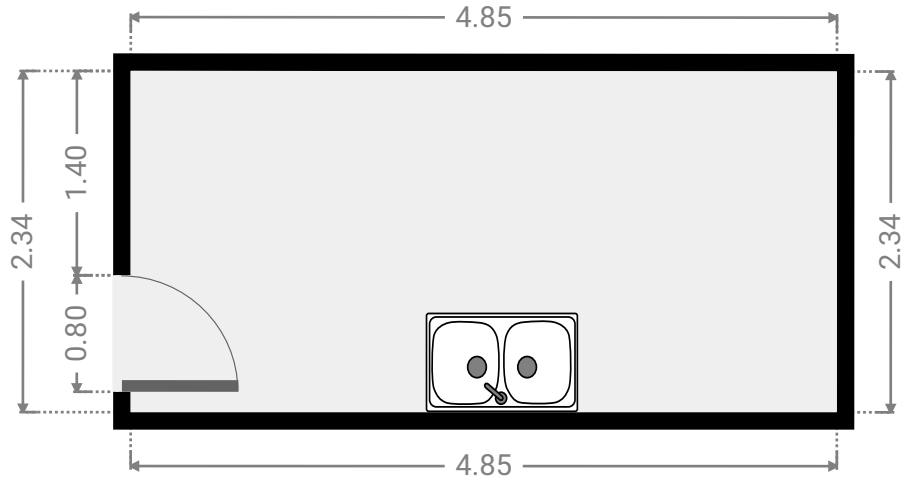
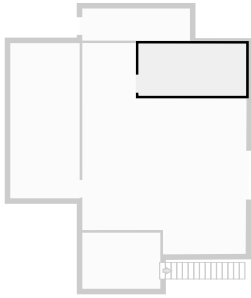

▼ **Other**
Ground Floor

WIDTH: 3.52 m • LENGTH: 2.53 m
AREA: 8.91 m² • PERIMETER: 12.10 m

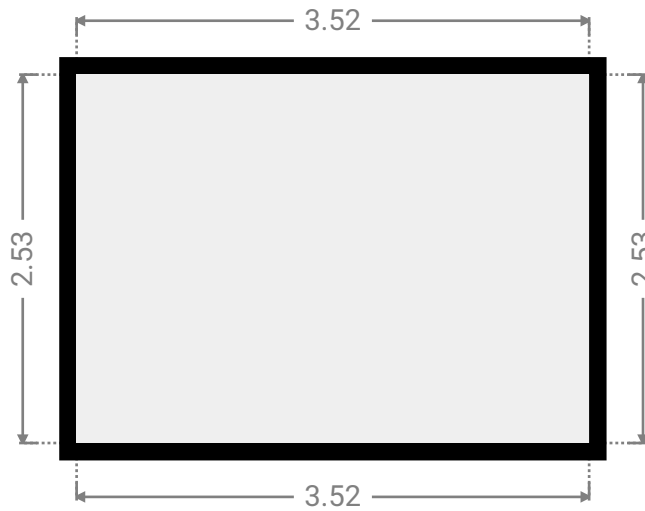
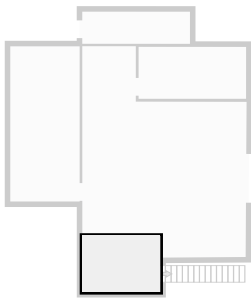

▼ **Carport**
Ground Floor

WIDTH: 3.13 m • LENGTH: 7.00 m
AREA: 21.91 m² • PERIMETER: 20.26 m

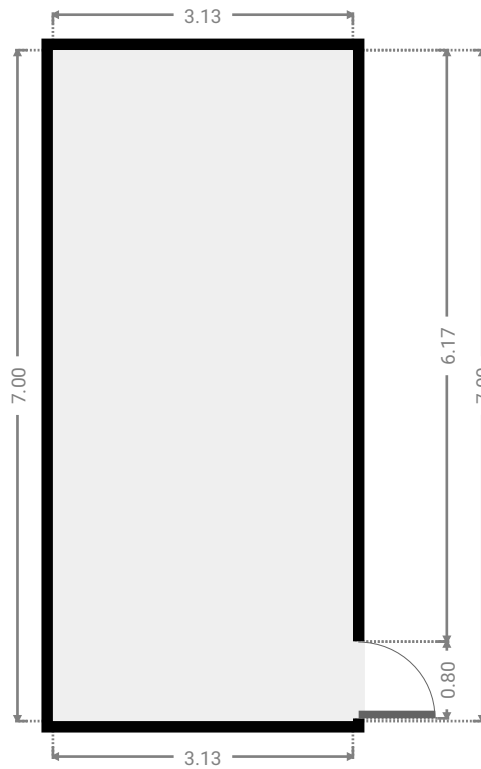
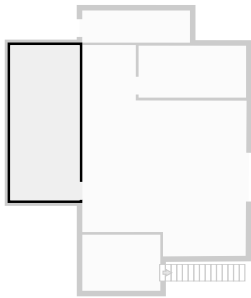

▼ 1st Floor



▼ Living Room
1st Floor

WIDTH: 3.55 m • LENGTH: 2.42 m
AREA: 8.59 m² • PERIMETER: 11.94 m

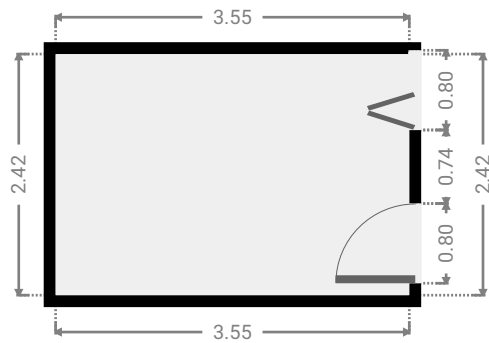
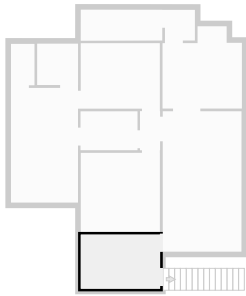

▼ Living Room
1st Floor

WIDTH: 3.52 m • LENGTH: 6.28 m
AREA: 22.12 m² • PERIMETER: 19.60 m

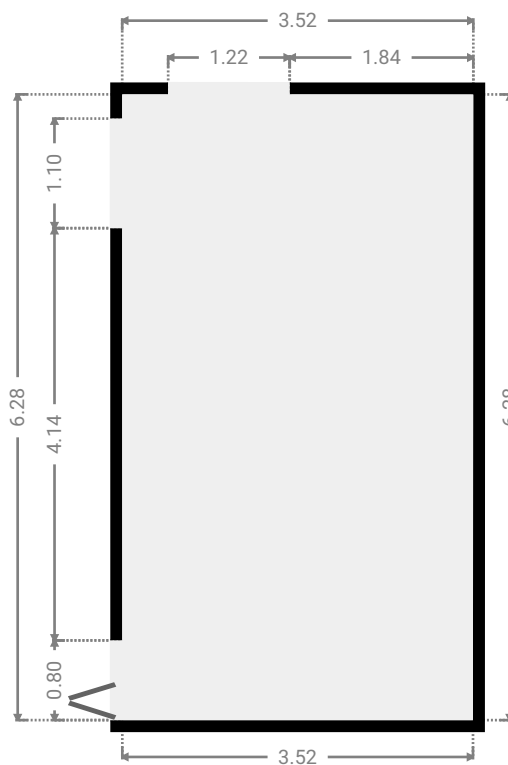
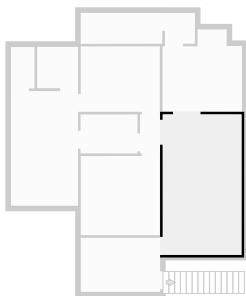

▼ Kitchen
1st Floor

WIDTH: 3.55 m • LENGTH: 3.68 m
AREA: 11.38 m² • PERIMETER: 14.46 m

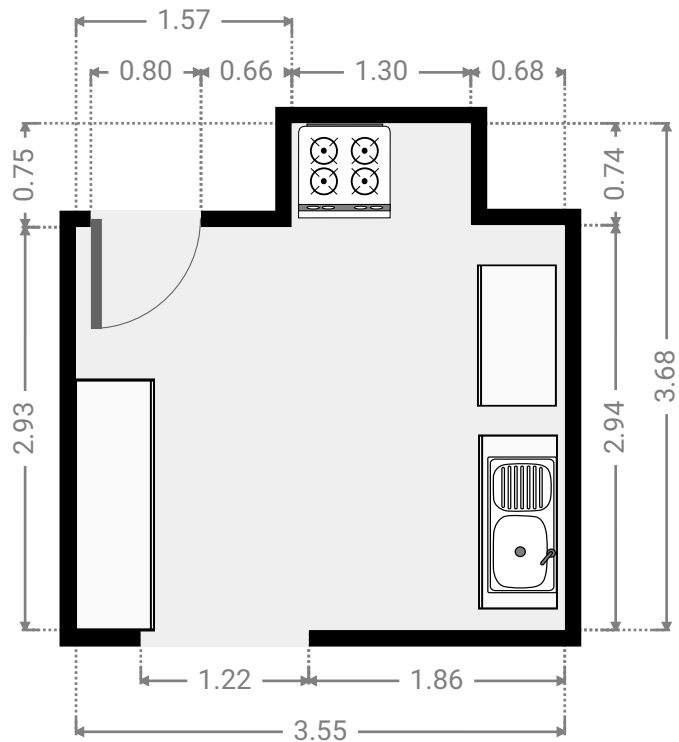
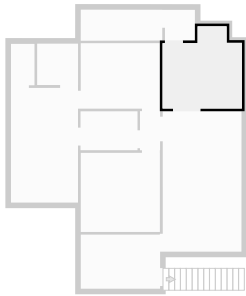

▼ Hall
1st Floor

WIDTH: 0.90 m • LENGTH: 1.75 m
AREA: 1.57 m² • PERIMETER: 5.30 m

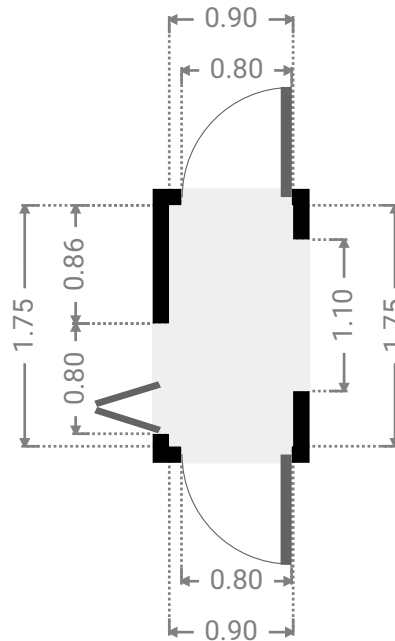
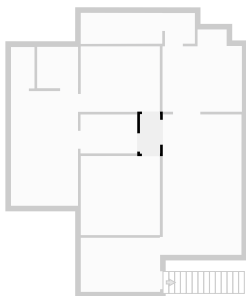

FLOORS: 2

▼ **Bedroom**
1st Floor

WIDTH: 3.54 m • LENGTH: 3.54 m
AREA: 12.53 m² • PERIMETER: 14.16 m

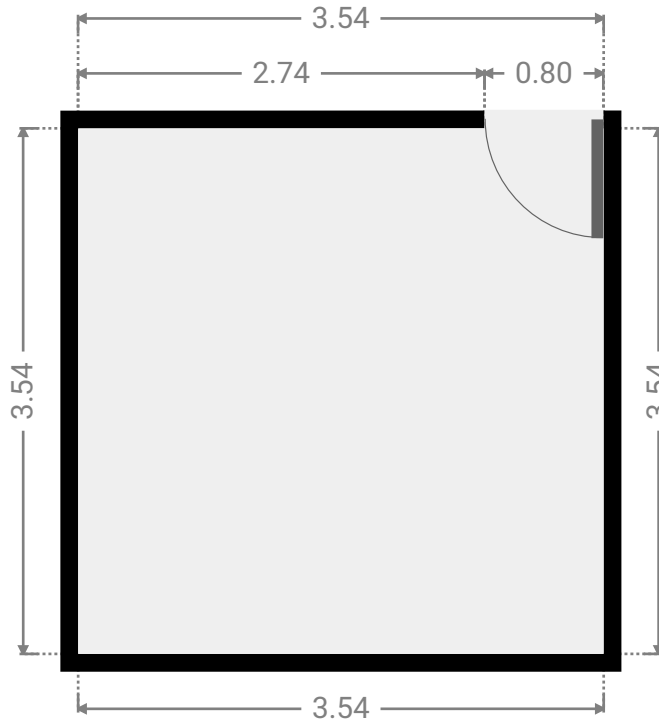
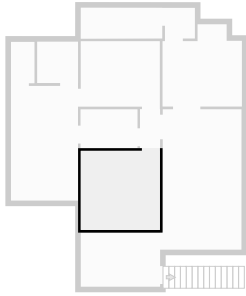

▼ **Hall**
1st Floor

WIDTH: 2.55 m • LENGTH: 1.74 m
AREA: 4.44 m² • PERIMETER: 8.58 m

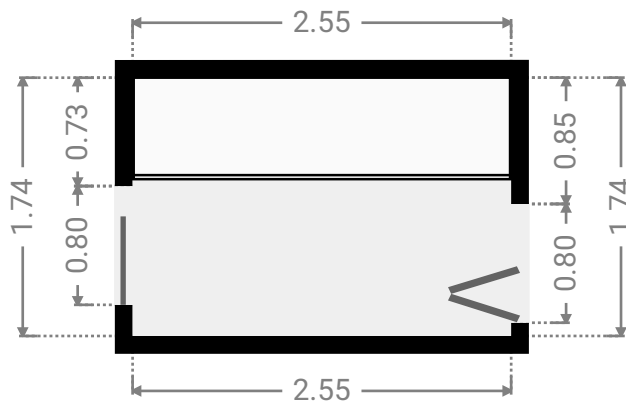
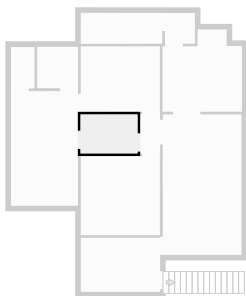

▼ **Bedroom**
1st Floor

WIDTH: 3.54 m • LENGTH: 2.93 m
AREA: 10.37 m² • PERIMETER: 12.94 m

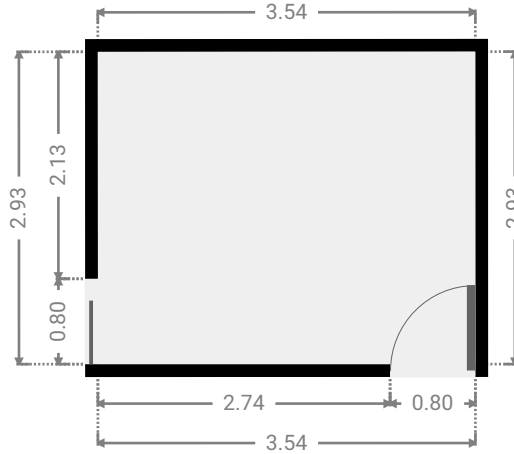
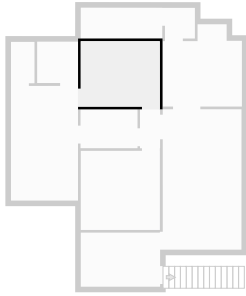

▼ **Bedroom**
1st Floor

WIDTH: 3.00 m • LENGTH: 5.13 m
AREA: 15.39 m² • PERIMETER: 16.26 m

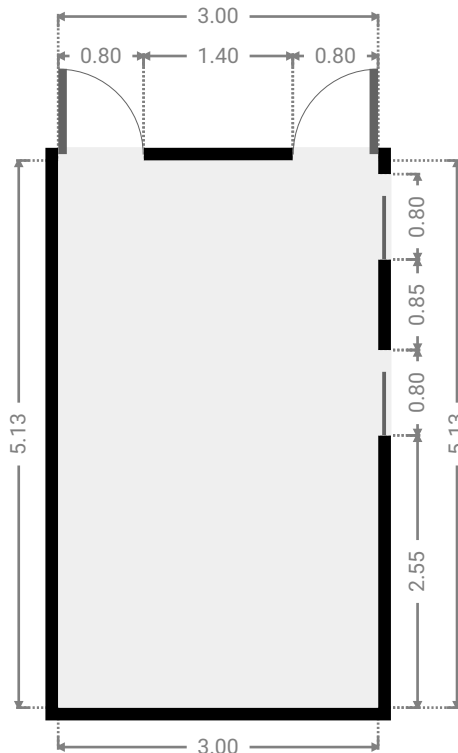
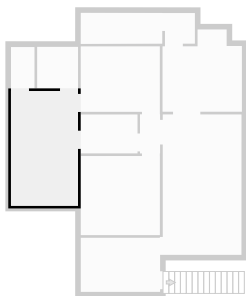

▼ **Bathroom**
1st Floor

WIDTH: 1.83 m • LENGTH: 1.85 m
AREA: 3.39 m² • PERIMETER: 7.36 m

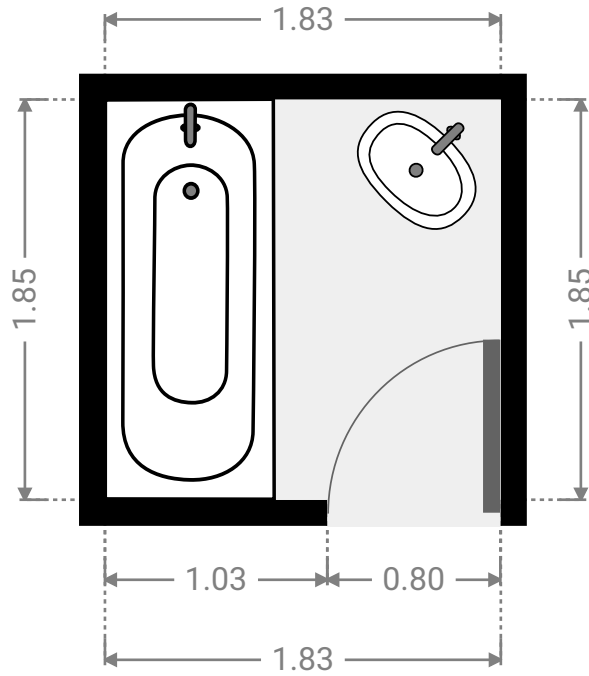
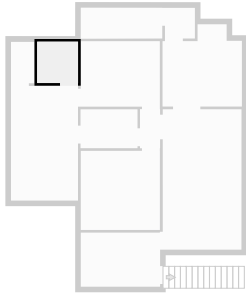

▼ **Toilet**
1st Floor

WIDTH: 1.05 m • LENGTH: 1.85 m
AREA: 1.95 m² • PERIMETER: 5.80 m

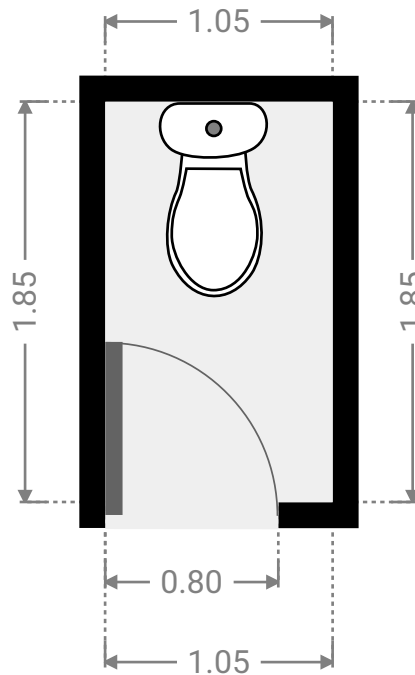
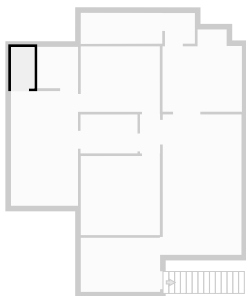

▼ Hall
1st Floor

WIDTH: 1.34 m • LENGTH: 1.37 m
AREA: 1.84 m² • PERIMETER: 5.42 m

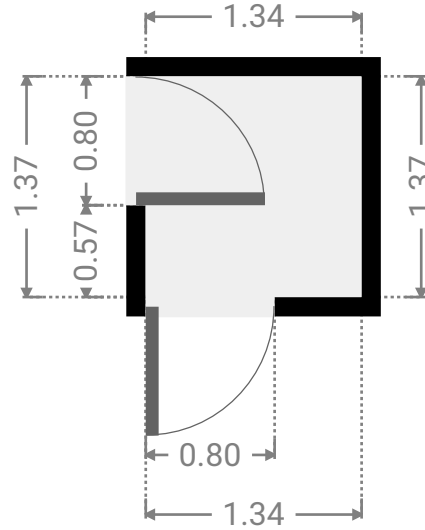
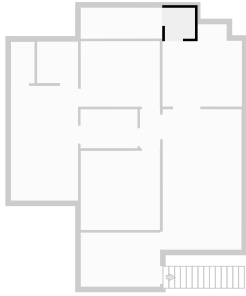

▼ Stairway
1st Floor

WIDTH: 3.65 m • LENGTH: 1.39 m
AREA: 5.05 m² • PERIMETER: 10.06 m

