

83 Simpson Street

Ground Floor

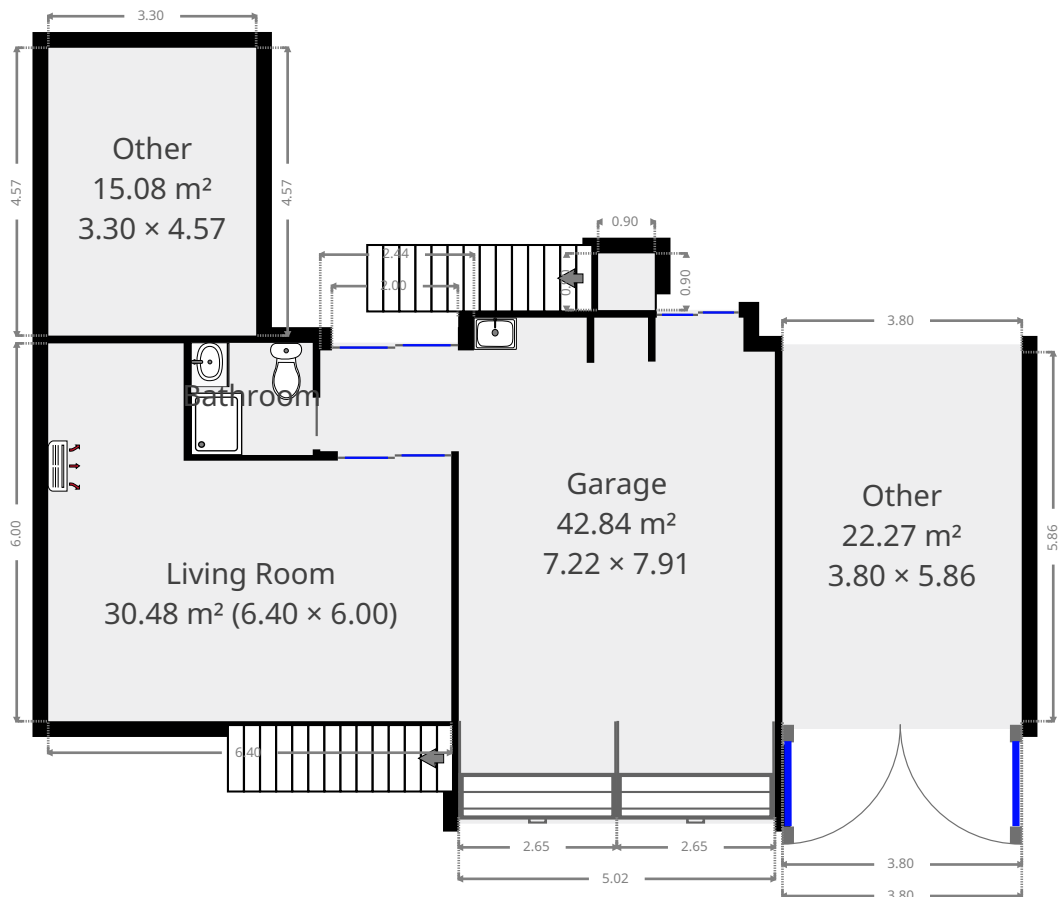

THIS FLOORPLAN IS PROVIDED WITHOUT WARRANTY OF ANY KIND. SENSOPIA DISCLAIMS ANY WARRANTY INCLUDING, WITHOUT LIMITATION, SATISFACTORY QUALITY OR ACCURACY OF DIMENSIONS.

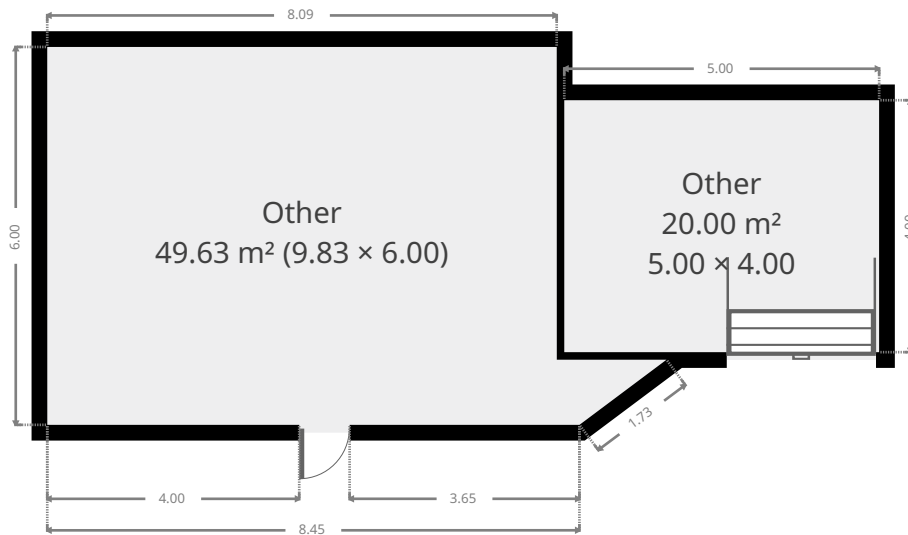

83 Simpson Street

Garage

Width: 7.22 m
Length: 7.91 m
Area: 42.84 m²
Perimeter: 30.26 m

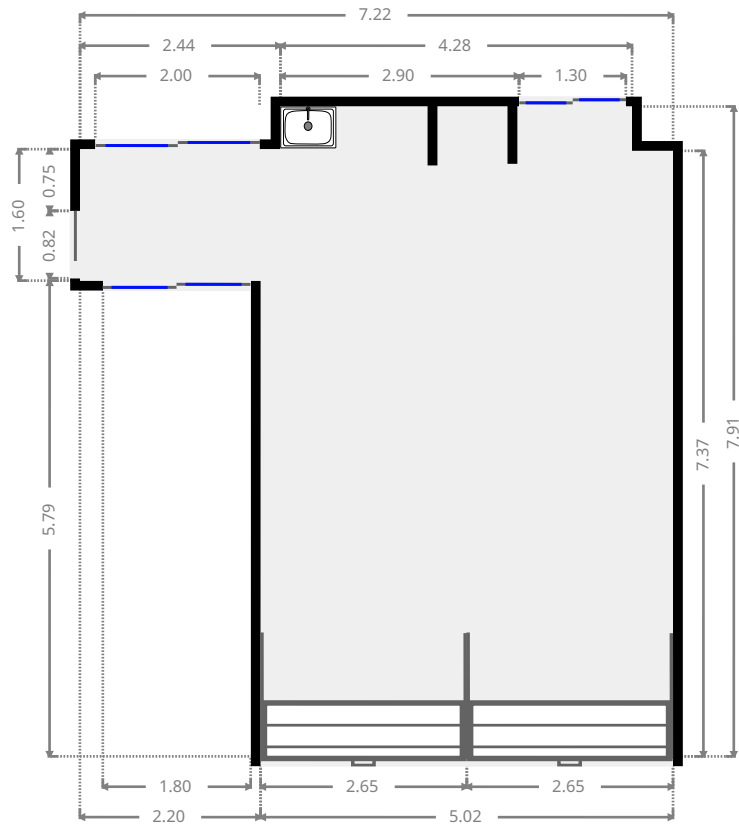
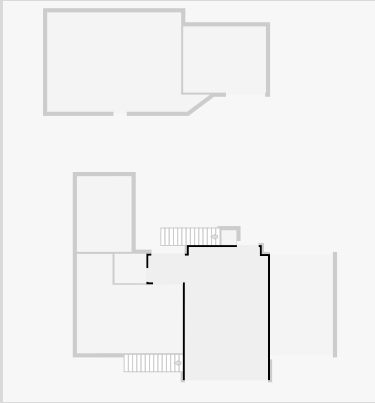

Bathroom

Width: 1.78 m
Length: 1.93 m
Area: 3.43 m²
Perimeter: 7.42 m

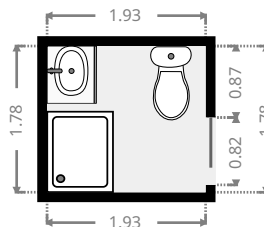
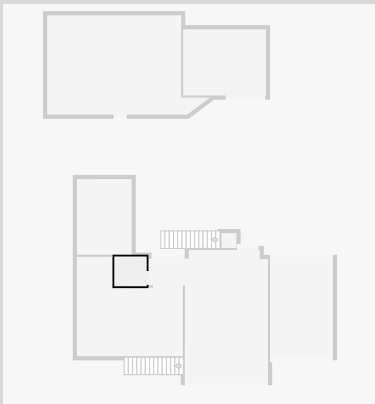

THIS FLOORPLAN IS PROVIDED WITHOUT WARRANTY OF ANY KIND. SENSOPIA DISCLAIMS ANY WARRANTY INCLUDING, WITHOUT LIMITATION, SATISFACTORY QUALITY OR ACCURACY OF DIMENSIONS.

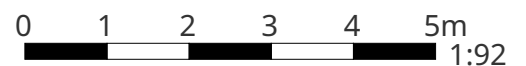

83 Simpson Street

Living Room

Width: 6.00 m
Length: 6.40 m
Area: 30.48 m²
Perimeter: 24.80 m

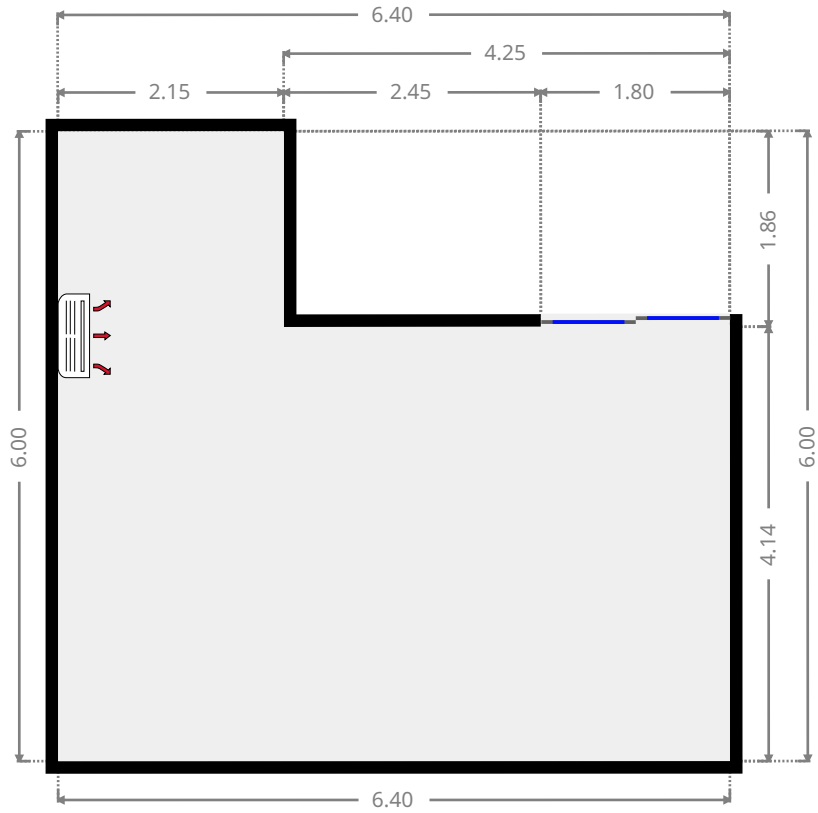
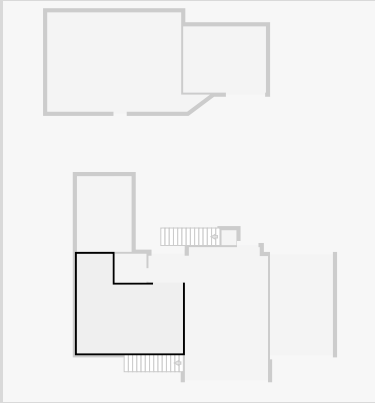

Other

Width: 0.90 m
Length: 0.90 m
Area: 0.81 m²
Perimeter: 3.60 m

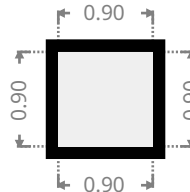
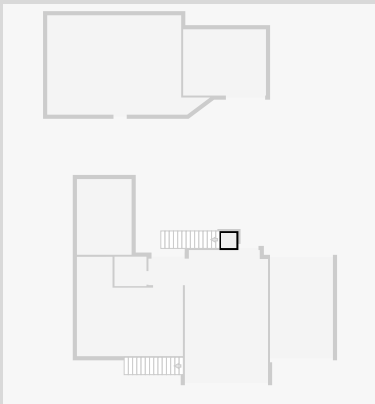

83 Simpson Street

Other

Width: 3.30 m
Length: 4.57 m
Area: 15.08 m²
Perimeter: 15.74 m

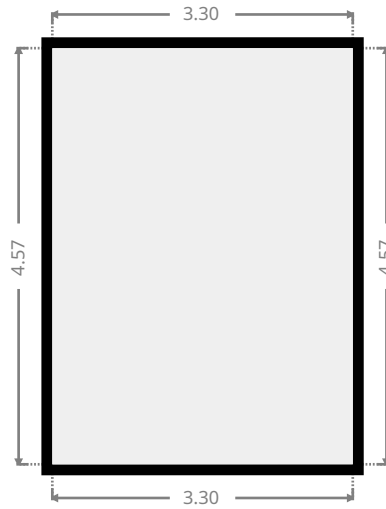
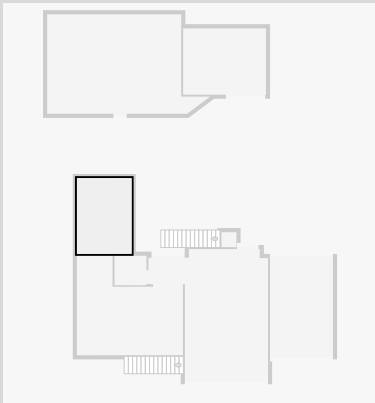

Other

Width: 3.80 m
Length: 5.86 m
Area: 22.27 m²
Perimeter: 19.32 m

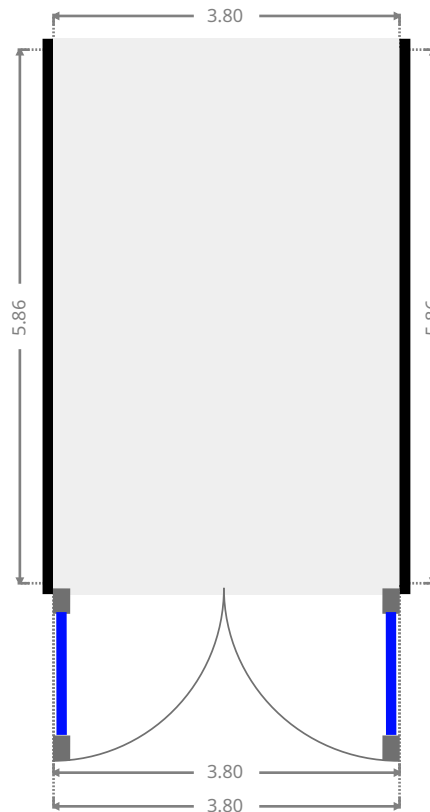
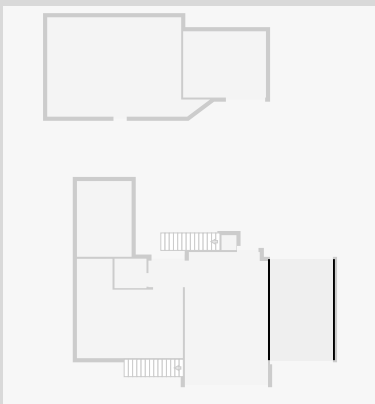

THIS FLOORPLAN IS PROVIDED WITHOUT WARRANTY OF ANY KIND. SENSOPIA DISCLAIMS ANY WARRANTY INCLUDING, WITHOUT LIMITATION, SATISFACTORY QUALITY OR ACCURACY OF DIMENSIONS.



83 Simpson Street

Other

Width: 4.00 m
Length: 5.00 m
Area: 20.00 m²
Perimeter: 18.00 m

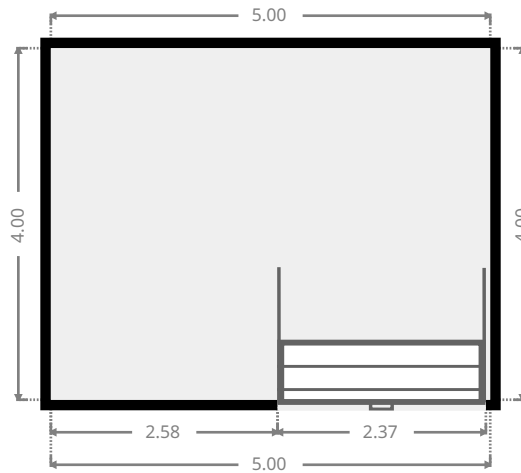
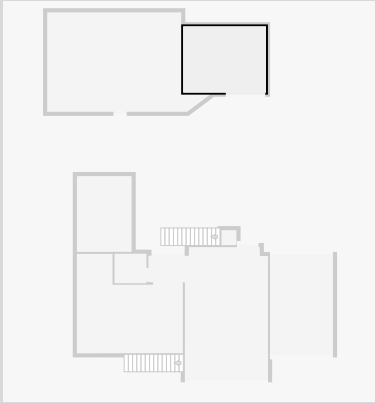

Other

Width: 6.00 m
Length: 9.83 m
Area: 49.63 m²
Perimeter: 30.97 m

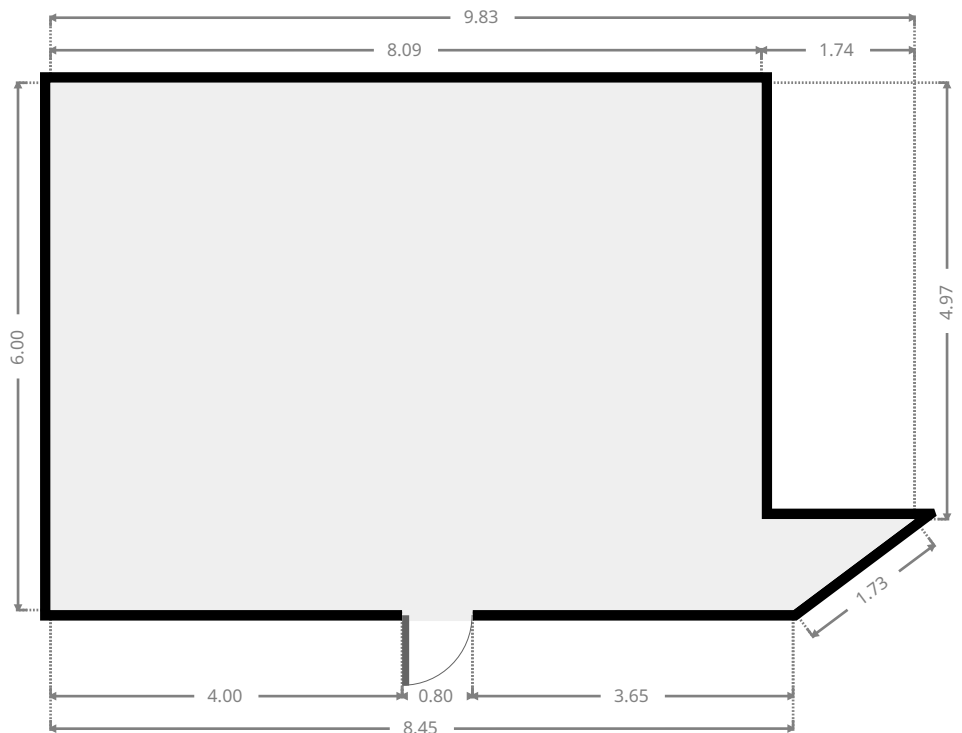
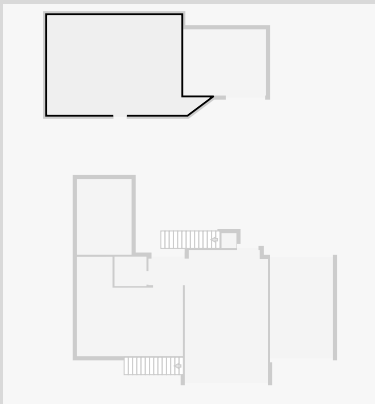

THIS FLOORPLAN IS PROVIDED WITHOUT WARRANTY OF ANY KIND. SENSOPIA DISCLAIMS ANY WARRANTY INCLUDING, WITHOUT LIMITATION, SATISFACTORY QUALITY OR ACCURACY OF DIMENSIONS.



83 Simpson Street

1st Floor

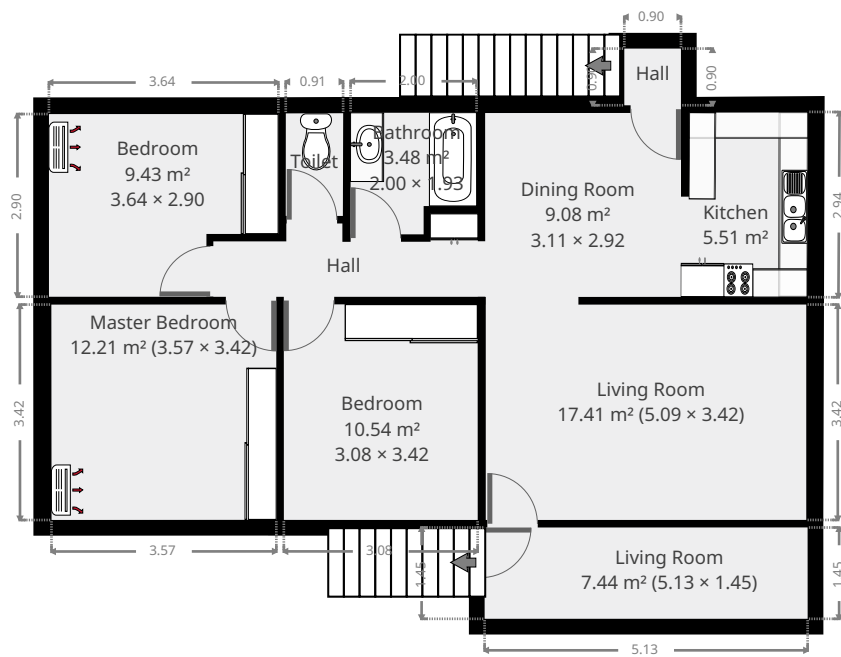

THIS FLOORPLAN IS PROVIDED WITHOUT WARRANTY OF ANY KIND. SENSOPIA DISCLAIMS ANY WARRANTY INCLUDING, WITHOUT LIMITATION, SATISFACTORY QUALITY OR ACCURACY OF DIMENSIONS.



83 Simpson Street

Living Room

Width: 3.42 m
 Length: 5.09 m
 Area: 17.41 m²
 Perimeter: 17.02 m

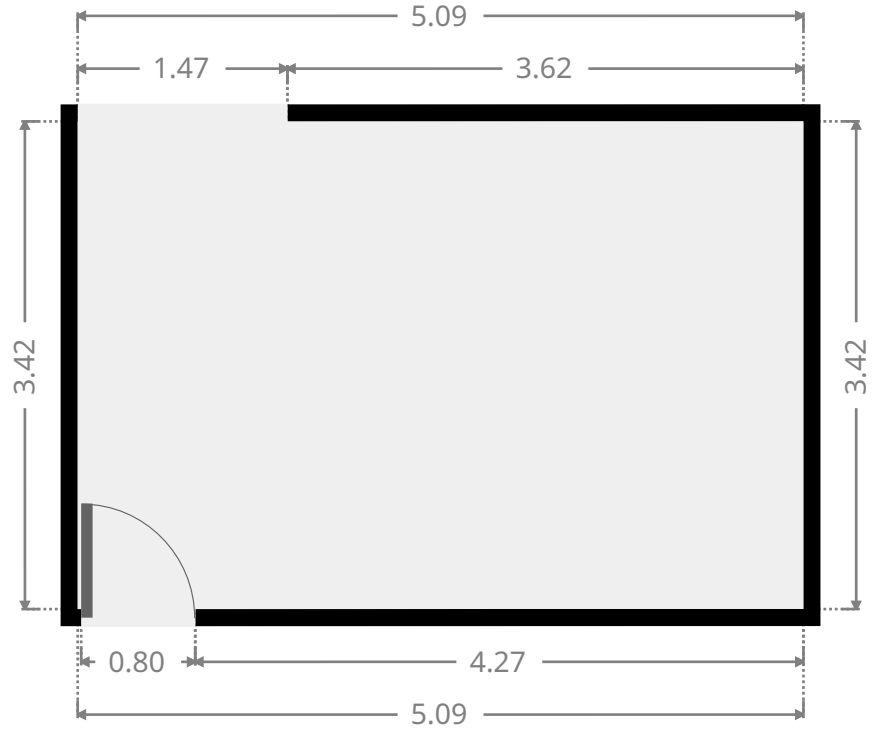
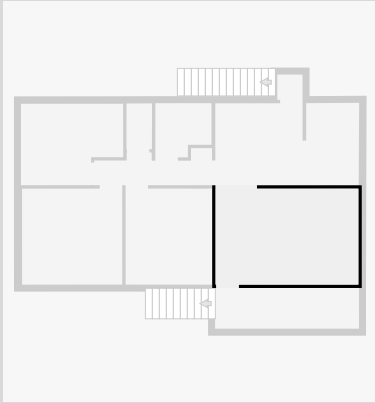

Living Room

Width: 1.45 m
 Length: 5.13 m
 Area: 7.44 m²
 Perimeter: 13.16 m

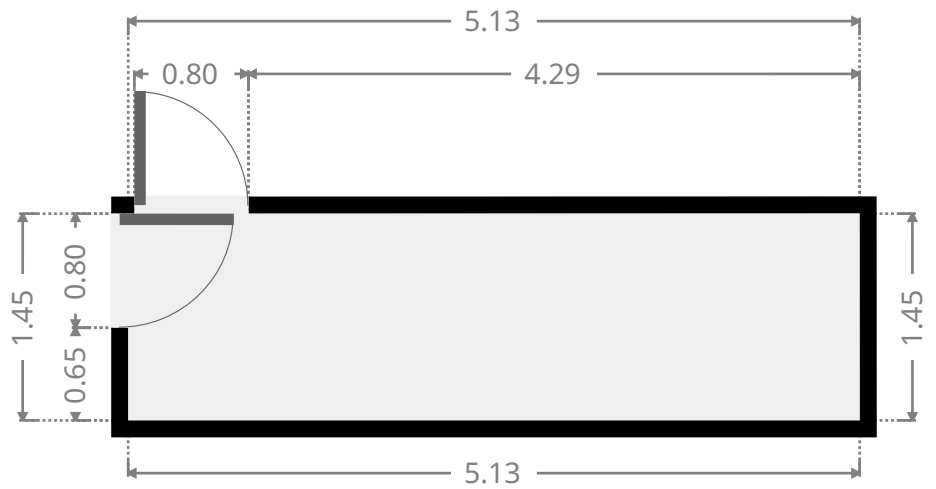
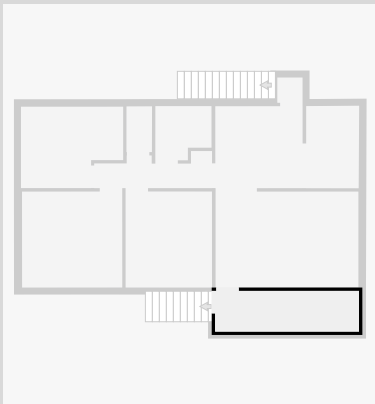

THIS FLOORPLAN IS PROVIDED WITHOUT WARRANTY OF ANY KIND. SENSOPIA DISCLAIMS ANY WARRANTY INCLUDING, WITHOUT LIMITATION, SATISFACTORY QUALITY OR ACCURACY OF DIMENSIONS.

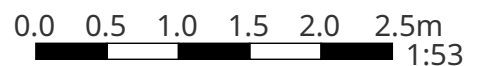

83 Simpson Street

Dining Room

Width: 2.92 m
 Length: 3.11 m
 Area: 9.08 m²
 Perimeter: 12.06 m

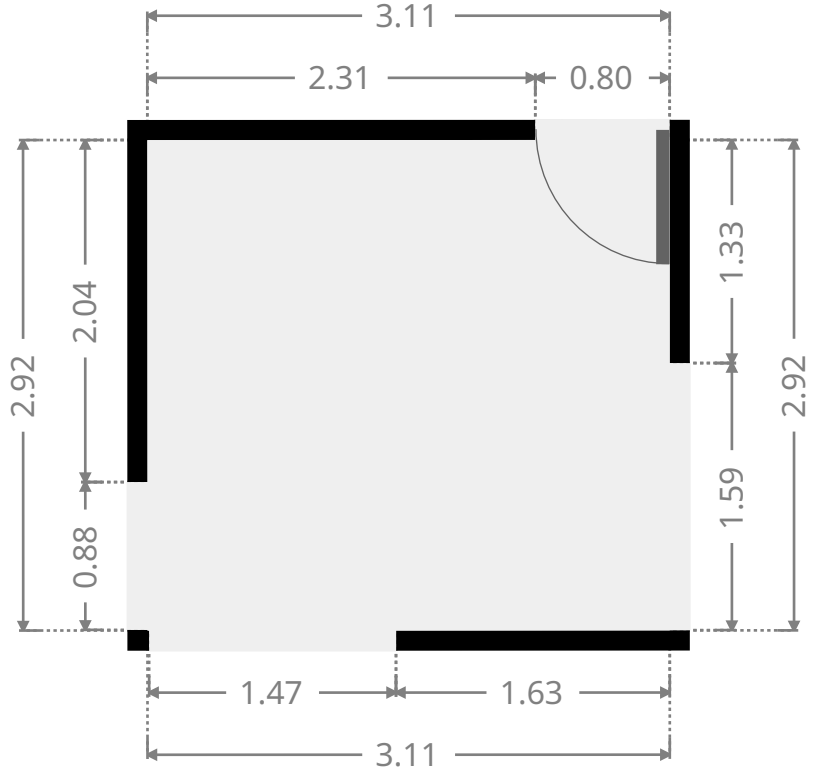
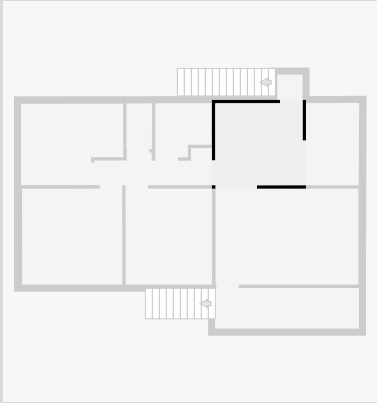

Kitchen

Width: 1.89 m
 Length: 2.94 m
 Area: 5.51 m²
 Perimeter: 9.62 m

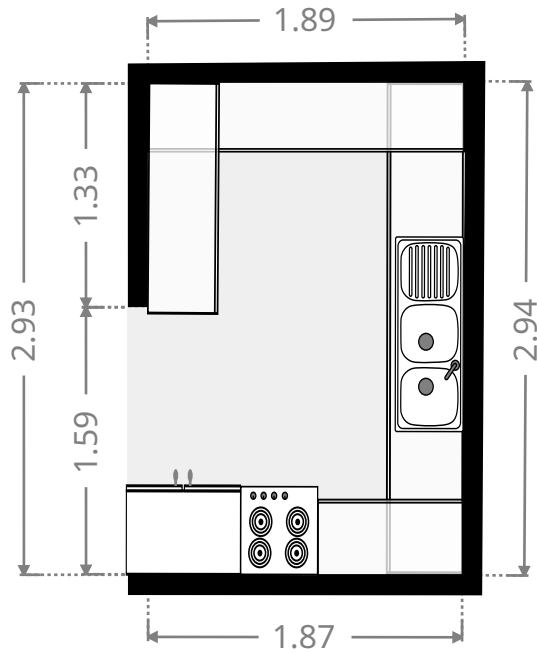
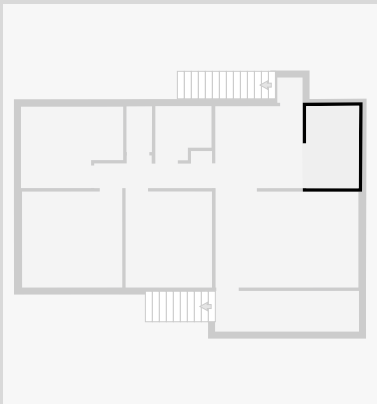

THIS FLOORPLAN IS PROVIDED WITHOUT WARRANTY OF ANY KIND. SENSOPIA DISCLAIMS ANY WARRANTY INCLUDING, WITHOUT LIMITATION, SATISFACTORY QUALITY OR ACCURACY OF DIMENSIONS.

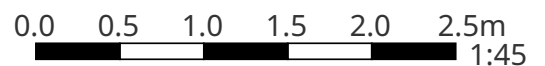

83 Simpson Street

Hall

Width: 1.32 m
 Length: 4.20 m
 Area: 4.27 m²
 Perimeter: 11.62 m

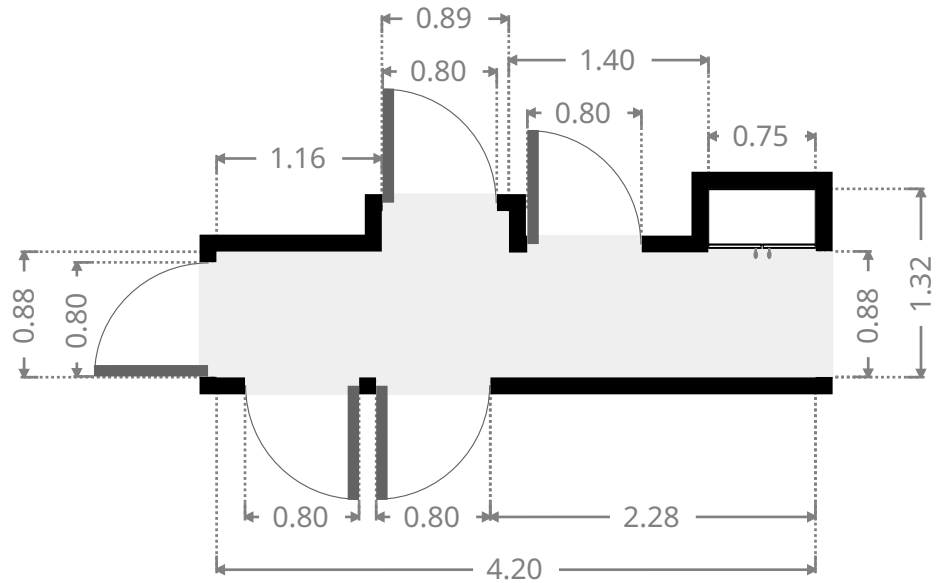
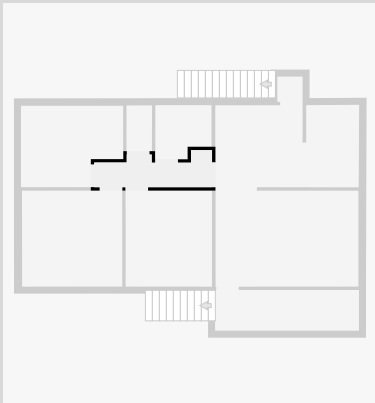

Bathroom

Width: 1.93 m
 Length: 2.00 m
 Area: 3.48 m²
 Perimeter: 7.86 m

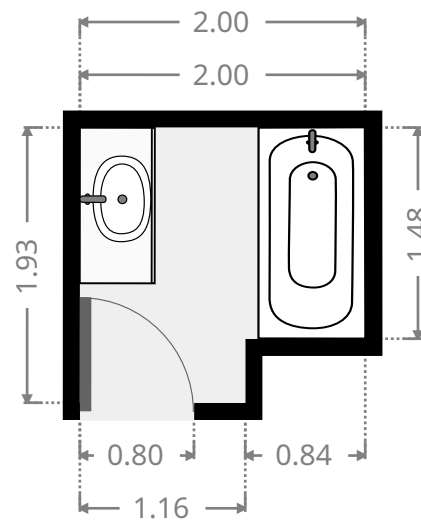
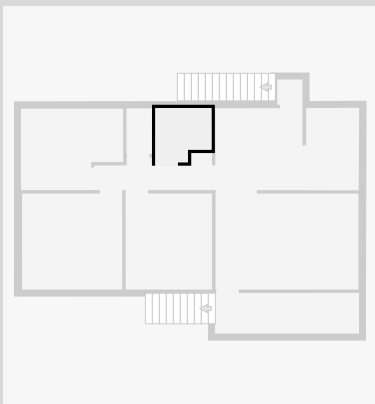

THIS FLOORPLAN IS PROVIDED WITHOUT WARRANTY OF ANY KIND. SENSOPIA DISCLAIMS ANY WARRANTY INCLUDING, WITHOUT LIMITATION, SATISFACTORY QUALITY OR ACCURACY OF DIMENSIONS.

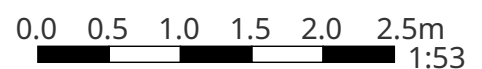

83 Simpson Street

Toilet / Half Bath

Width: 0.91 m
 Length: 1.63 m
 Area: 1.48 m²
 Perimeter: 5.08 m

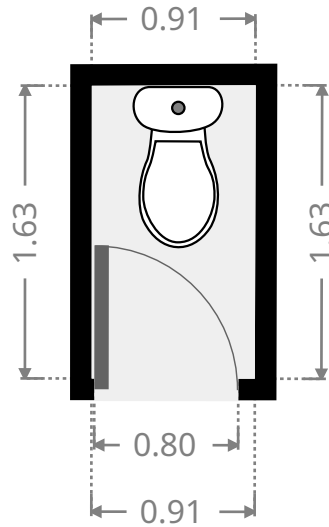
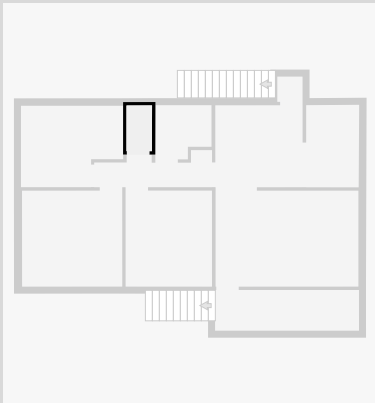

Bedroom

Width: 2.90 m
 Length: 3.64 m
 Area: 9.43 m²
 Perimeter: 13.09 m

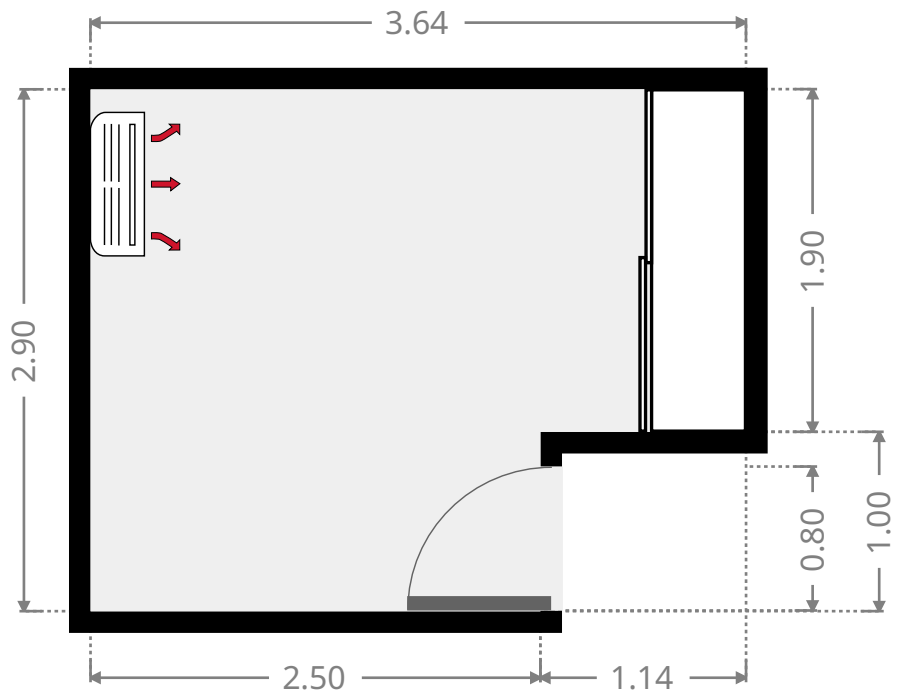
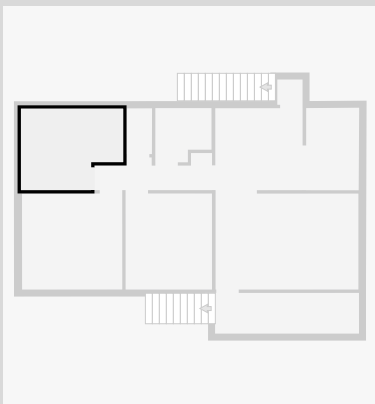

THIS FLOORPLAN IS PROVIDED WITHOUT WARRANTY OF ANY KIND. SENSOPIA DISCLAIMS ANY WARRANTY INCLUDING, WITHOUT LIMITATION, SATISFACTORY QUALITY OR ACCURACY OF DIMENSIONS.

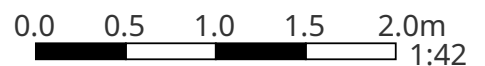

83 Simpson Street

Master Bedroom

Width: 3.42 m
 Length: 3.57 m
 Area: 12.21 m²
 Perimeter: 13.98 m

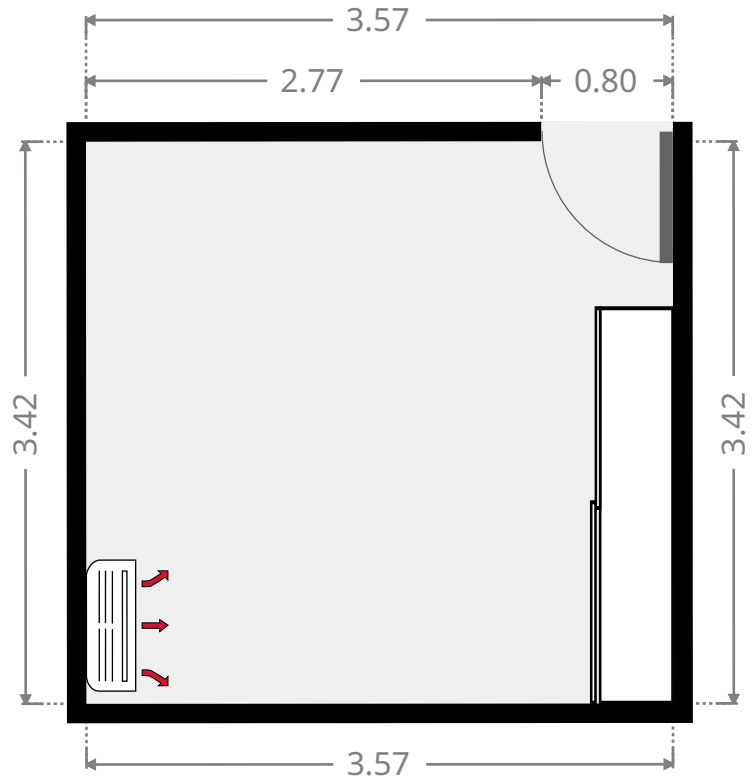
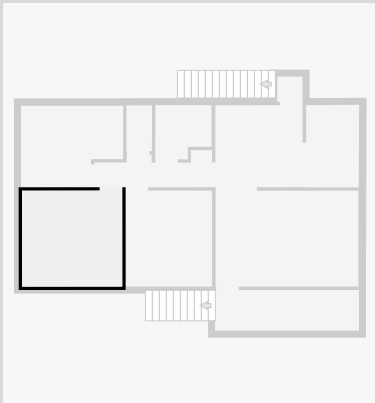

Bedroom

Width: 3.08 m
 Length: 3.42 m
 Area: 10.54 m²
 Perimeter: 13.00 m

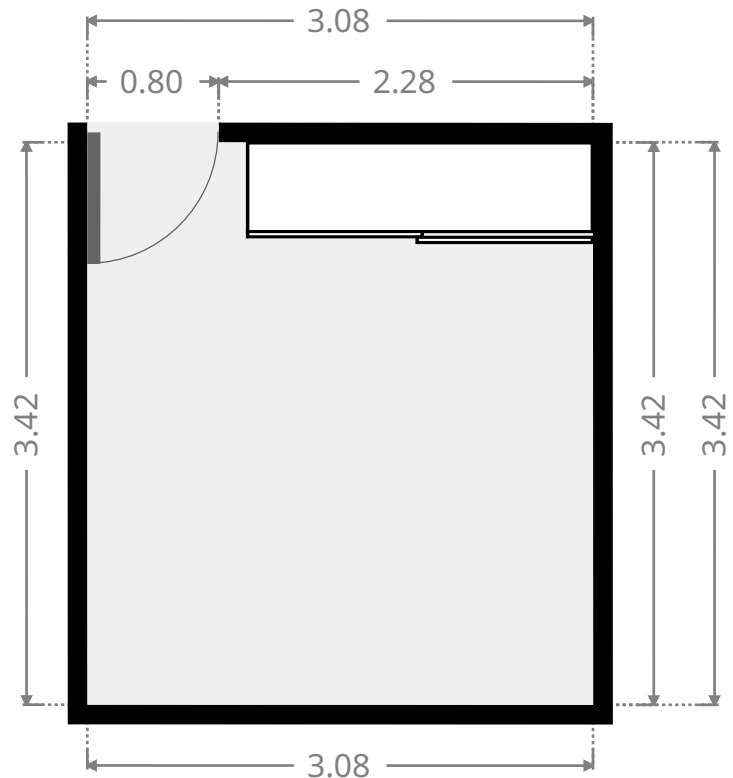
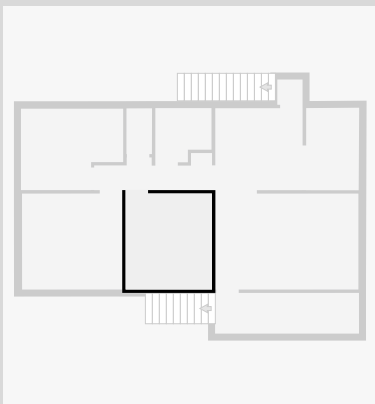

THIS FLOORPLAN IS PROVIDED WITHOUT WARRANTY OF ANY KIND. SENSOPIA DISCLAIMS ANY WARRANTY INCLUDING, WITHOUT LIMITATION, SATISFACTORY QUALITY OR ACCURACY OF DIMENSIONS.

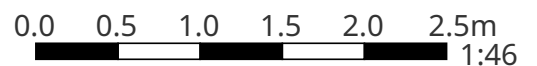

83 Simpson Street

Hall

Width:	0.90 m
Length:	0.90 m
Area	0.81 m ²
Perimeter	3.60 m

