

# 83 Constance Avenue

## Ground Floor

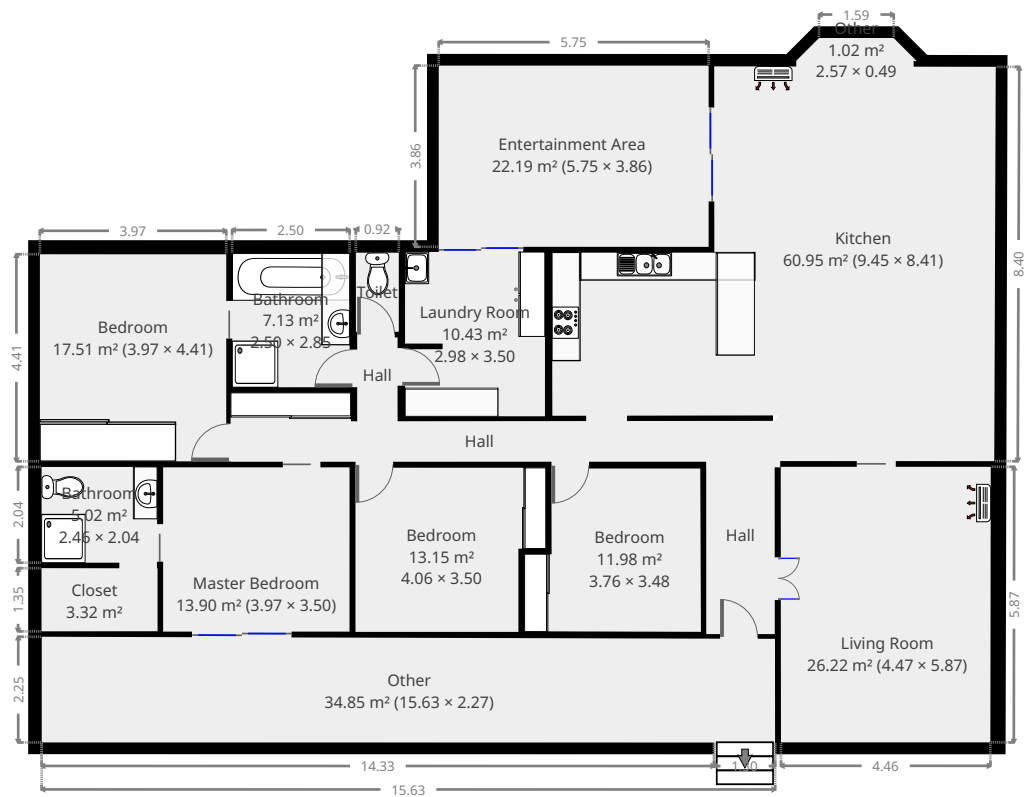

THIS FLOORPLAN IS PROVIDED WITHOUT WARRANTY OF ANY KIND. SENSOPIA DISCLAIMS ANY WARRANTY INCLUDING, WITHOUT LIMITATION, SATISFACTORY QUALITY OR ACCURACY OF DIMENSIONS.

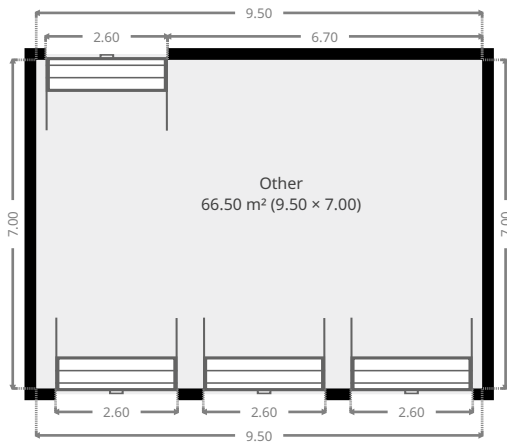

# 83 Constance Avenue

## Toilet / Half Bath

Width: 0.92 m  
Length: 1.69 m  
Area: 1.54 m<sup>2</sup>  
Perimeter: 5.20 m

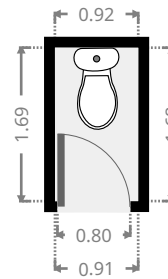
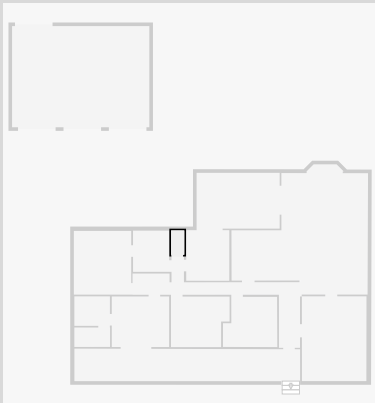

## Other

Width: 7.00 m  
Length: 9.50 m  
Area: 66.50 m<sup>2</sup>  
Perimeter: 33.00 m

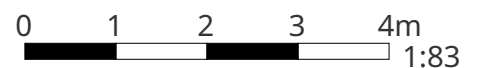
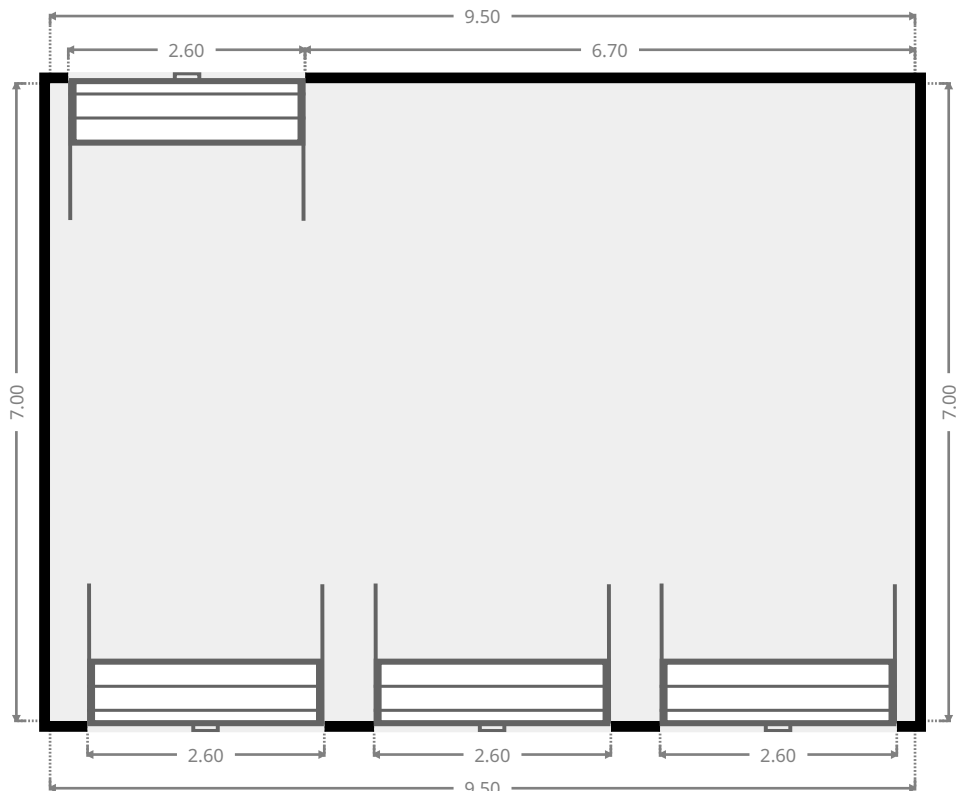
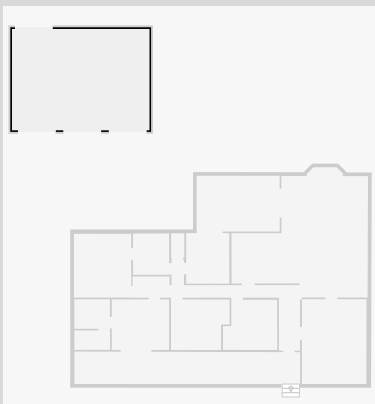

THIS FLOORPLAN IS PROVIDED WITHOUT WARRANTY OF ANY KIND. SENSOPIA DISCLAIMS ANY WARRANTY INCLUDING, WITHOUT LIMITATION, SATISFACTORY QUALITY OR ACCURACY OF DIMENSIONS.

# 83 Constance Avenue

## Entertainment Area

Width: 3.86 m  
Length: 5.75 m  
Area: 22.19 m<sup>2</sup>  
Perimeter: 19.22 m

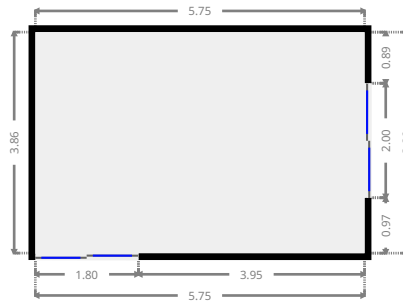
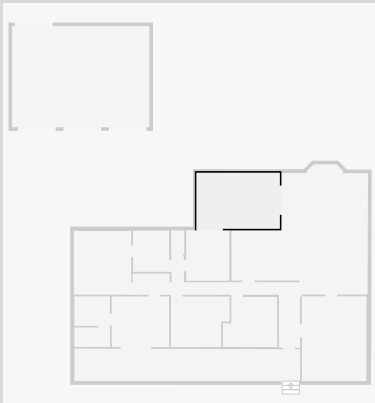

## Other

Width: 2.27 m  
Length: 15.63 m  
Area: 34.85 m<sup>2</sup>  
Perimeter: 35.71 m

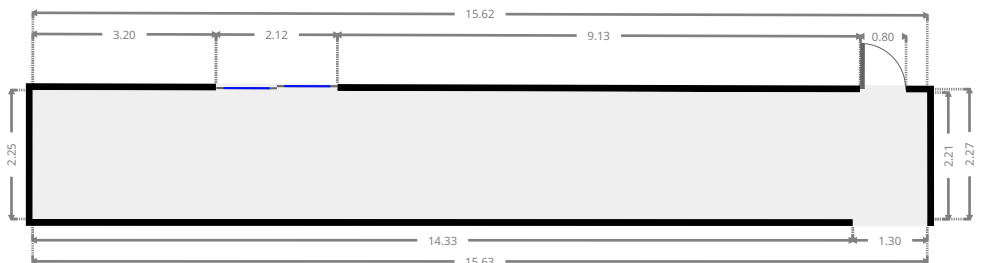
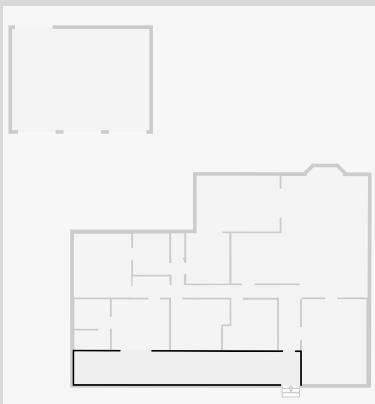

# 83 Constance Avenue

## Closet

Width: 1.35 m  
Length: 2.47 m  
Area: 3.32 m<sup>2</sup>  
Perimeter: 7.63 m

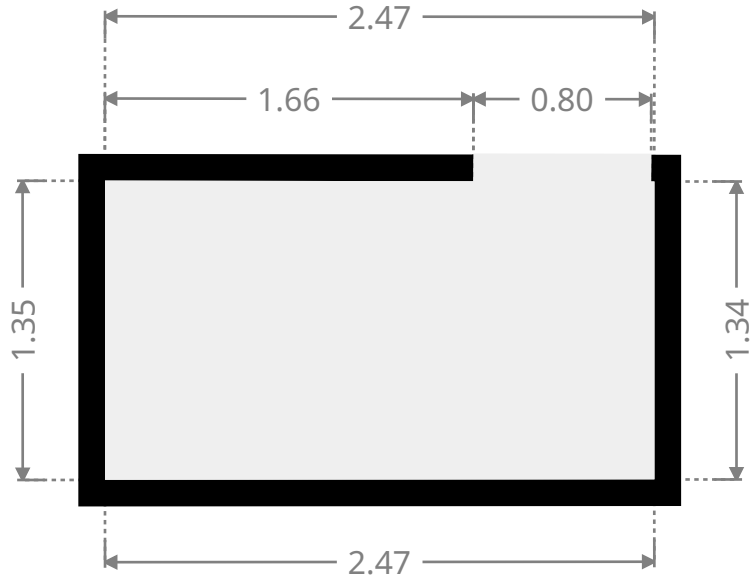
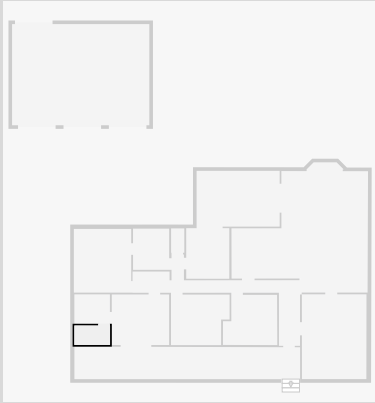

## Bathroom

Width: 2.04 m  
Length: 2.46 m  
Area: 5.02 m<sup>2</sup>  
Perimeter: 9.00 m

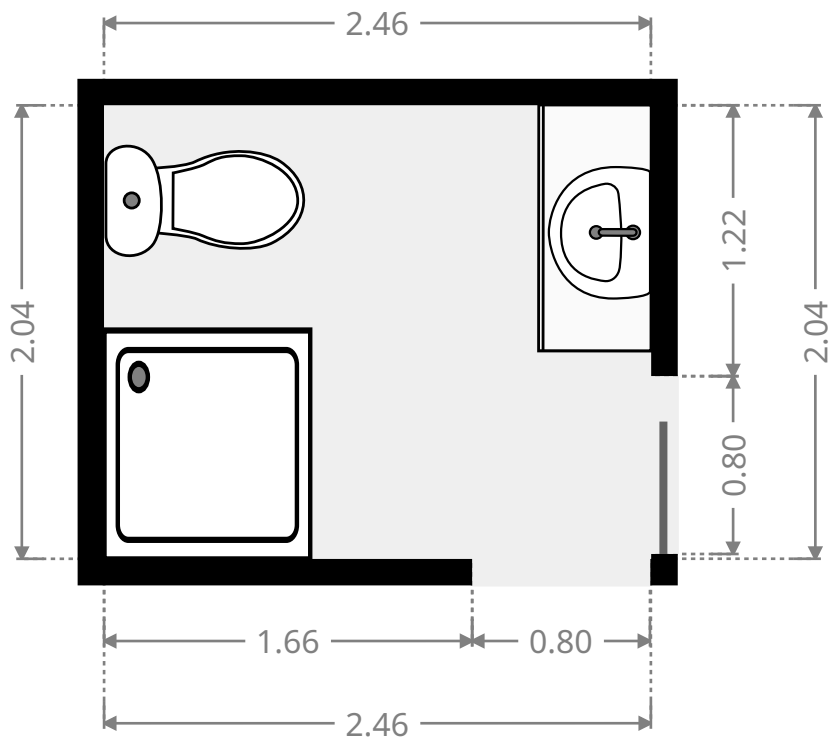
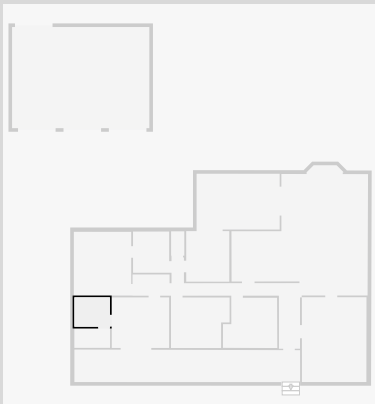

THIS FLOORPLAN IS PROVIDED WITHOUT WARRANTY OF ANY KIND. SENSOPIA DISCLAIMS ANY WARRANTY INCLUDING, WITHOUT LIMITATION, SATISFACTORY QUALITY OR ACCURACY OF DIMENSIONS.

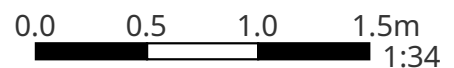

# 83 Constance Avenue

## Master Bedroom

Width: 3.50 m  
 Length: 3.97 m  
 Area: 13.90 m<sup>2</sup>  
 Perimeter: 14.94 m

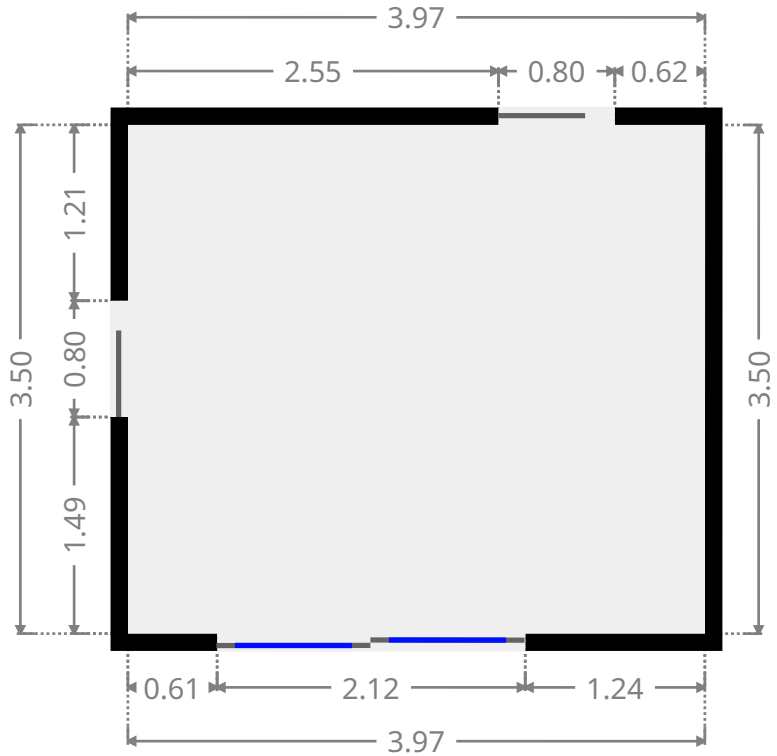
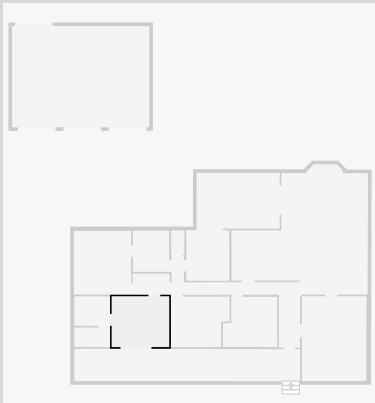

## Bedroom

Width: 3.97 m  
 Length: 4.41 m  
 Area: 17.51 m<sup>2</sup>  
 Perimeter: 16.76 m

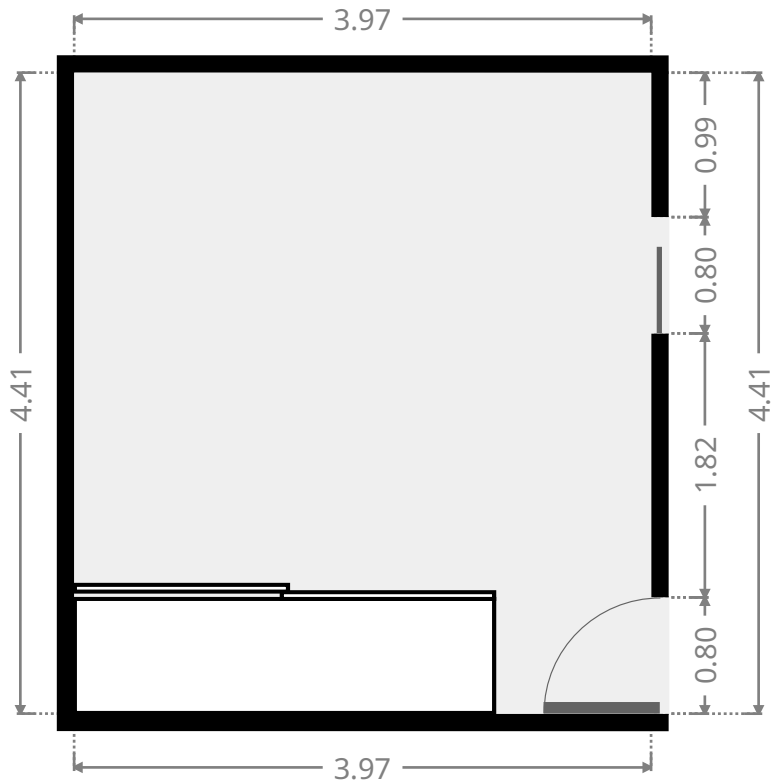
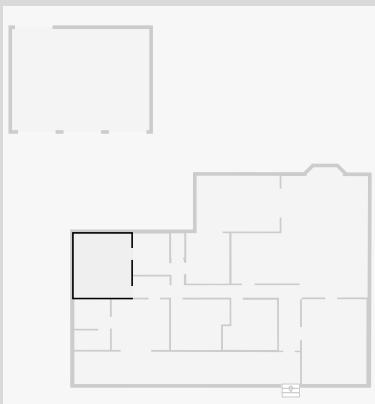

THIS FLOORPLAN IS PROVIDED WITHOUT WARRANTY OF ANY KIND. SENSOPIA DISCLAIMS ANY WARRANTY INCLUDING, WITHOUT LIMITATION, SATISFACTORY QUALITY OR ACCURACY OF DIMENSIONS.

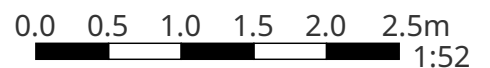

# 83 Constance Avenue

## Bathroom

Width: 2.50 m  
Length: 2.85 m  
Area: 7.13 m<sup>2</sup>  
Perimeter: 10.70 m

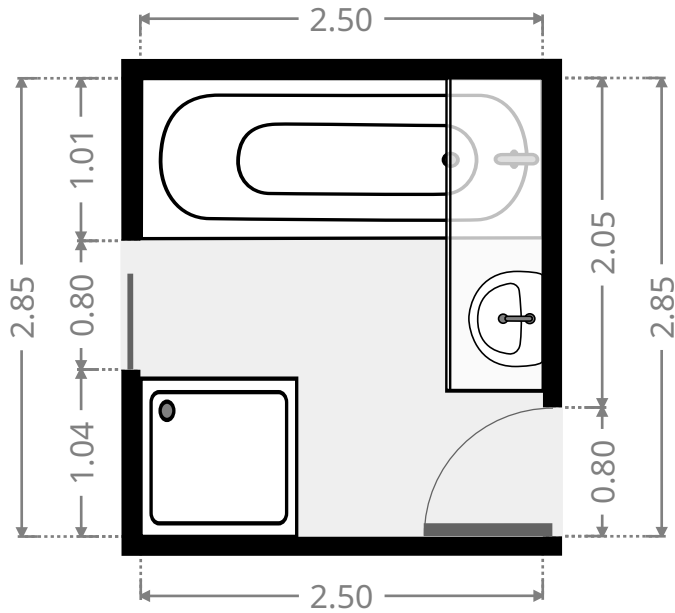
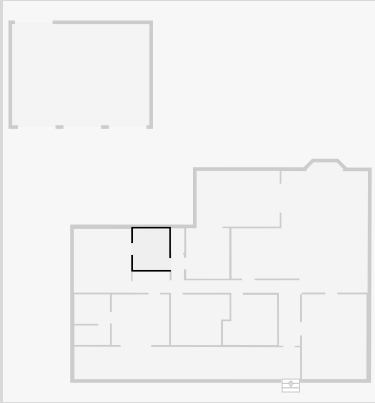

## Hall

Width: 1.46 m  
Length: 3.57 m  
Area: 5.21 m<sup>2</sup>  
Perimeter: 10.06 m

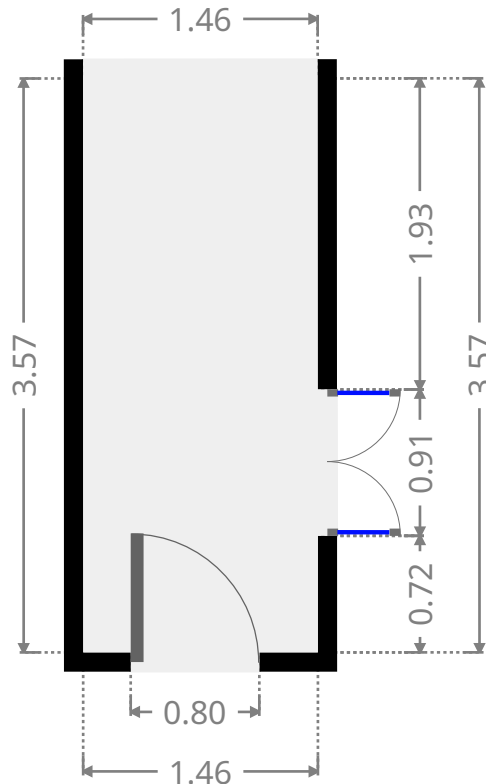
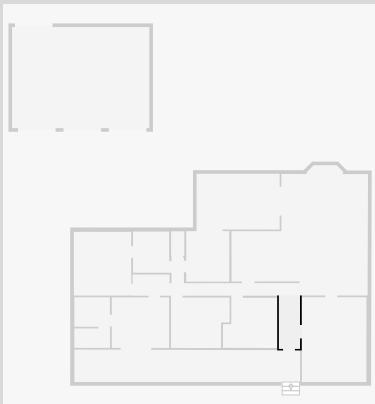

THIS FLOORPLAN IS PROVIDED WITHOUT WARRANTY OF ANY KIND. SENSOPIA DISCLAIMS ANY WARRANTY INCLUDING, WITHOUT LIMITATION, SATISFACTORY QUALITY OR ACCURACY OF DIMENSIONS.

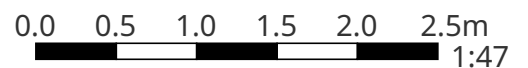

# 83 Constance Avenue

## Hall

Width: 0.86 m  
Length: 1.67 m  
Area: 1.44 m<sup>2</sup>  
Perimeter: 5.06 m

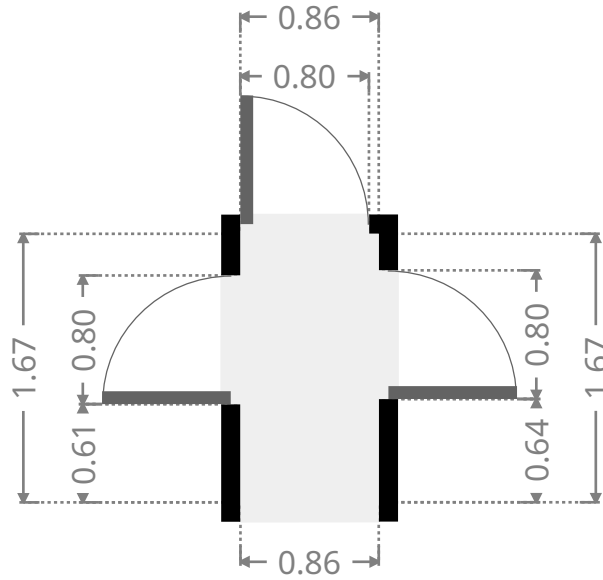
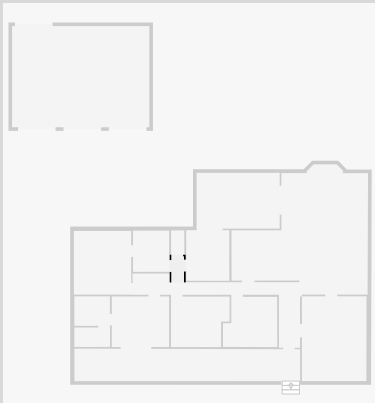

## Laundry Room

Width: 2.98 m  
Length: 3.50 m  
Area: 10.43 m<sup>2</sup>  
Perimeter: 12.96 m

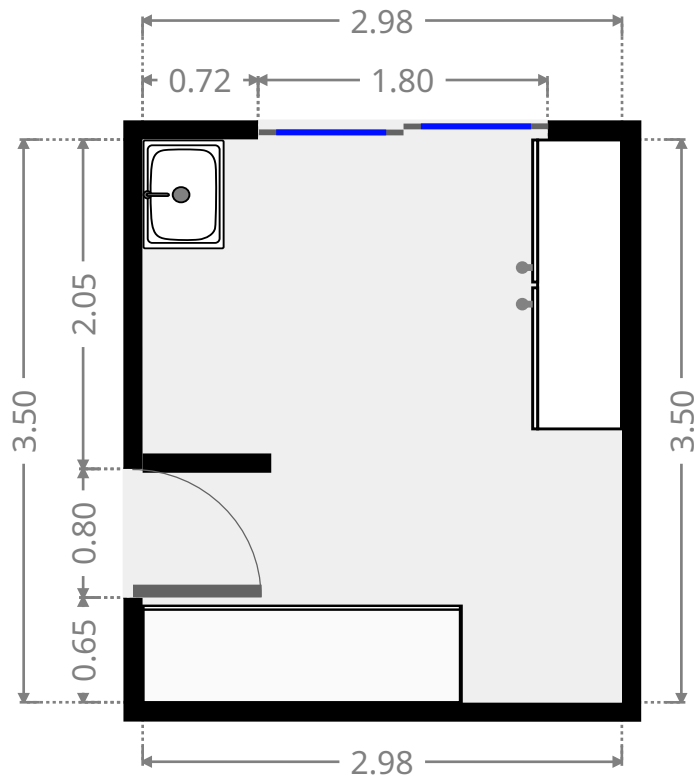
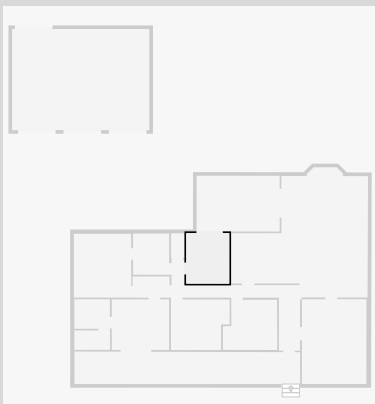

THIS FLOORPLAN IS PROVIDED WITHOUT WARRANTY OF ANY KIND. SENSOPIA DISCLAIMS ANY WARRANTY INCLUDING, WITHOUT LIMITATION, SATISFACTORY QUALITY OR ACCURACY OF DIMENSIONS.

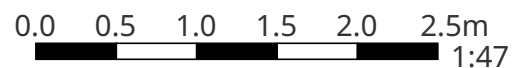

# 83 Constance Avenue

## Bedroom

Width: 3.50 m  
 Length: 4.06 m  
 Area: 13.15 m<sup>2</sup>  
 Perimeter: 15.11 m

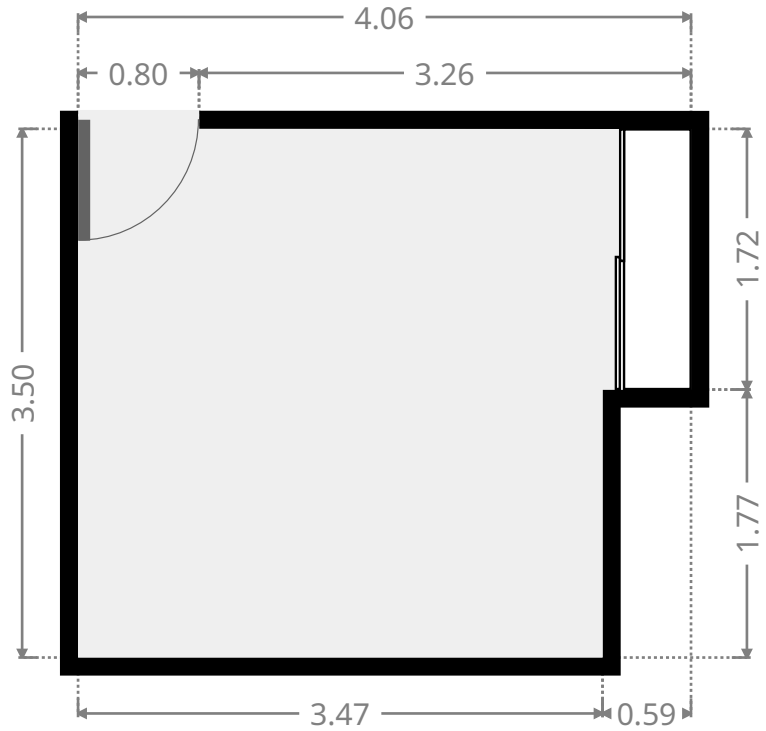
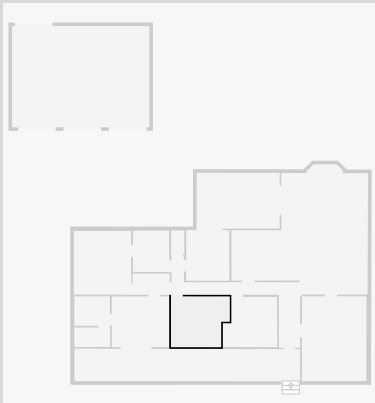

## Bedroom

Width: 3.48 m  
 Length: 3.76 m  
 Area: 11.98 m<sup>2</sup>  
 Perimeter: 14.46 m

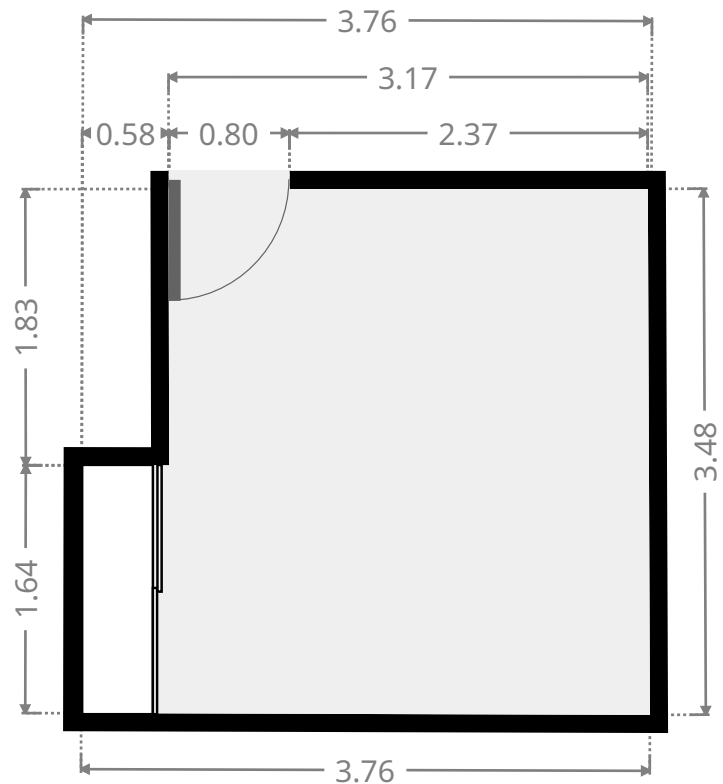
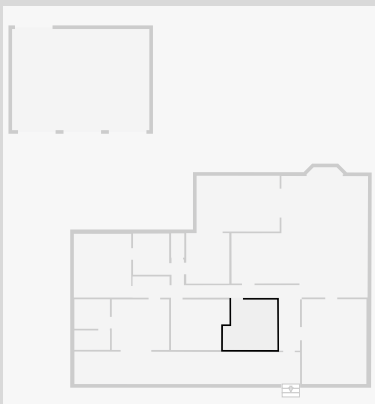

THIS FLOORPLAN IS PROVIDED WITHOUT WARRANTY OF ANY KIND. SENSOPIA DISCLAIMS ANY WARRANTY INCLUDING, WITHOUT LIMITATION, SATISFACTORY QUALITY OR ACCURACY OF DIMENSIONS.

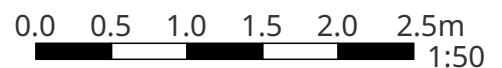



# 83 Constance Avenue

## Other

Width: 0.49 m  
 Length: 2.57 m  
 Area: 1.02 m<sup>2</sup>  
 Perimeter: 5.55 m

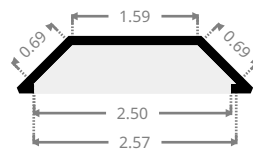
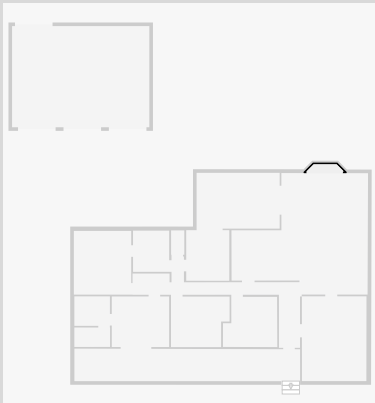

## Kitchen

Width: 8.41 m  
 Length: 9.45 m  
 Area: 60.95 m<sup>2</sup>  
 Perimeter: 35.69 m

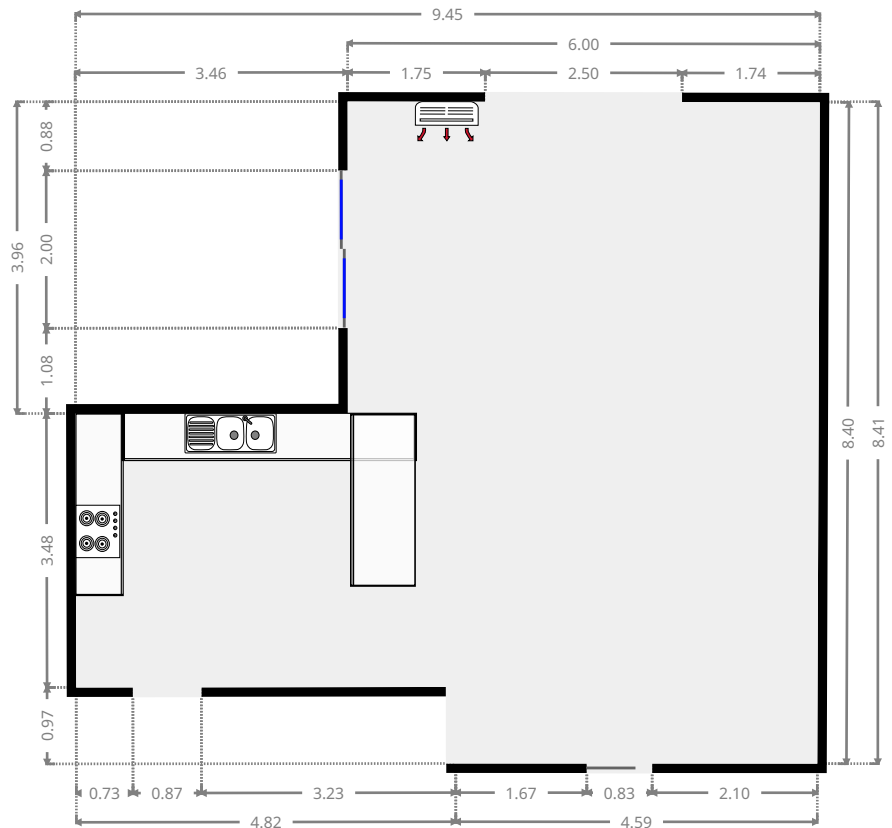
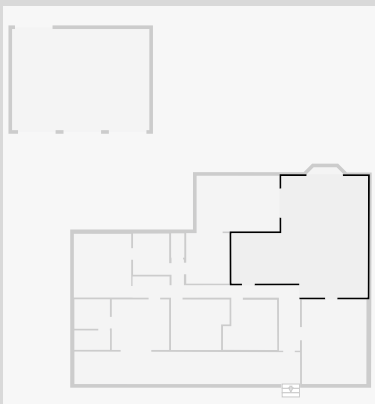

THIS FLOORPLAN IS PROVIDED WITHOUT WARRANTY OF ANY KIND. SENSOPIA DISCLAIMS ANY WARRANTY INCLUDING, WITHOUT LIMITATION, SATISFACTORY QUALITY OR ACCURACY OF DIMENSIONS.



# 83 Constance Avenue

## Living Room

Width: 4.47 m  
 Length: 5.87 m  
 Area: 26.22 m<sup>2</sup>  
 Perimeter: 20.67 m

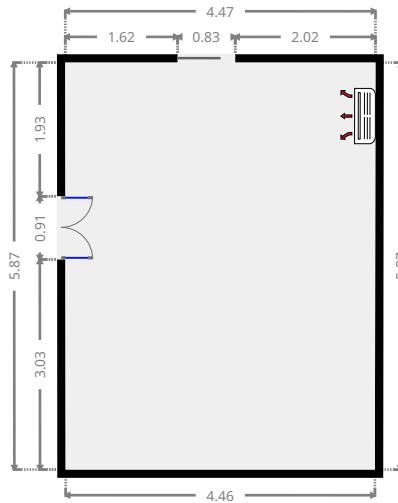
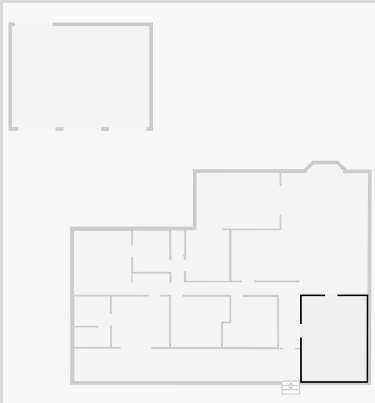

## Hall

Width: 1.47 m  
 Length: 11.59 m  
 Area: 11.58 m<sup>2</sup>  
 Perimeter: 26.12 m

