

81 Quarry Street

Ground Floor

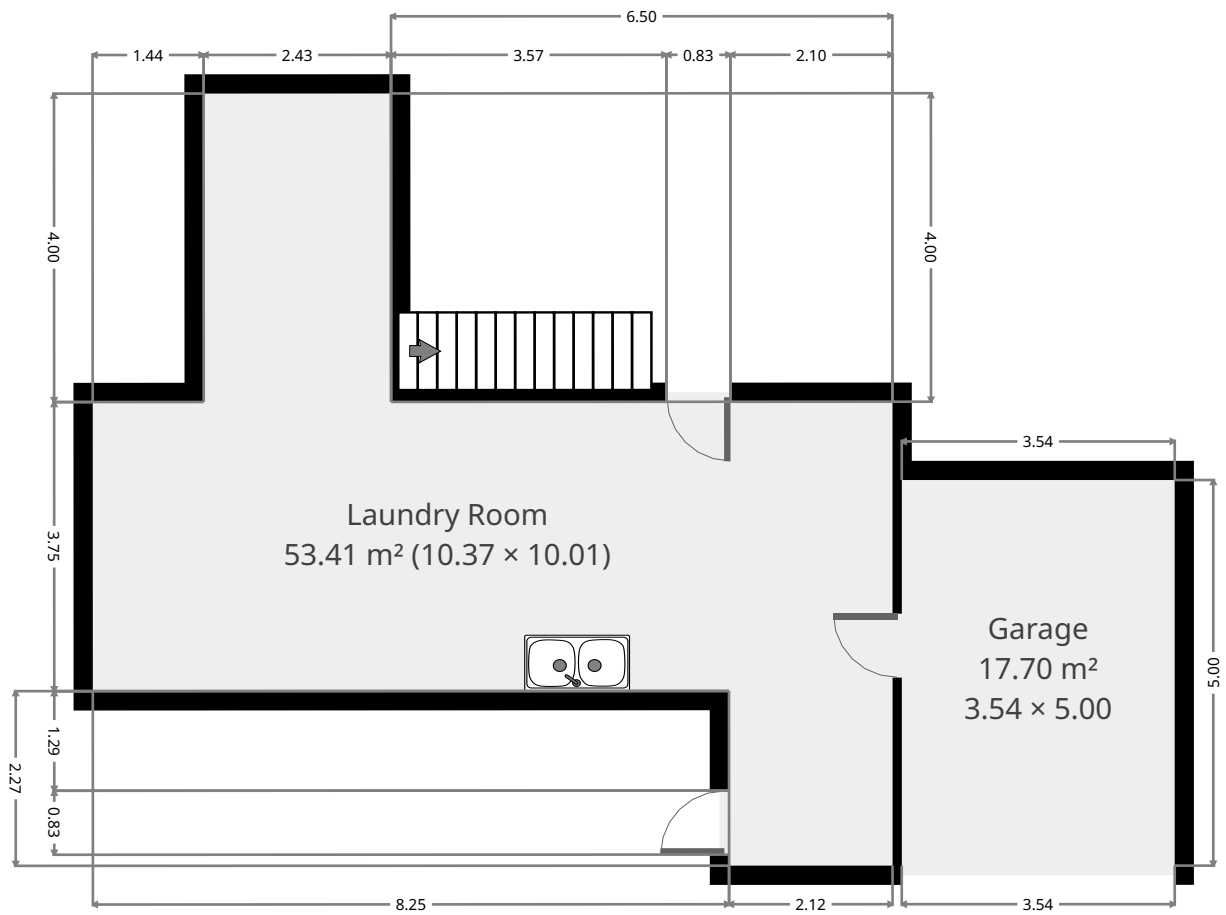

THIS FLOORPLAN IS PROVIDED WITHOUT WARRANTY OF ANY KIND. SENSOPIA DISCLAIMS ANY WARRANTY INCLUDING, WITHOUT LIMITATION, SATISFACTORY QUALITY OR ACCURACY OF DIMENSIONS.



81 Quarry Street

Garage

Width: 3.54 m
Length: 5.00 m
Area: 17.70 m²
Perimeter: 17.08 m

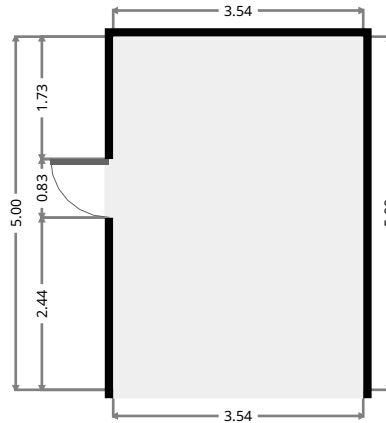
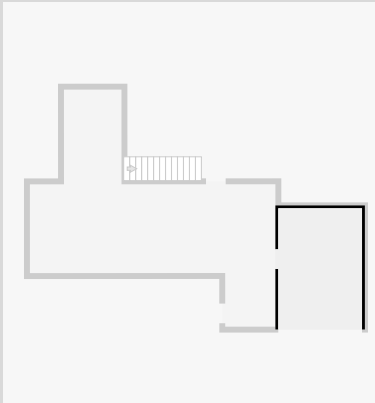

Laundry Room

Width: 10.01 m
Length: 10.37 m
Area: 53.41 m²
Perimeter: 40.77 m

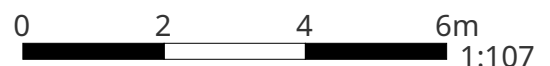
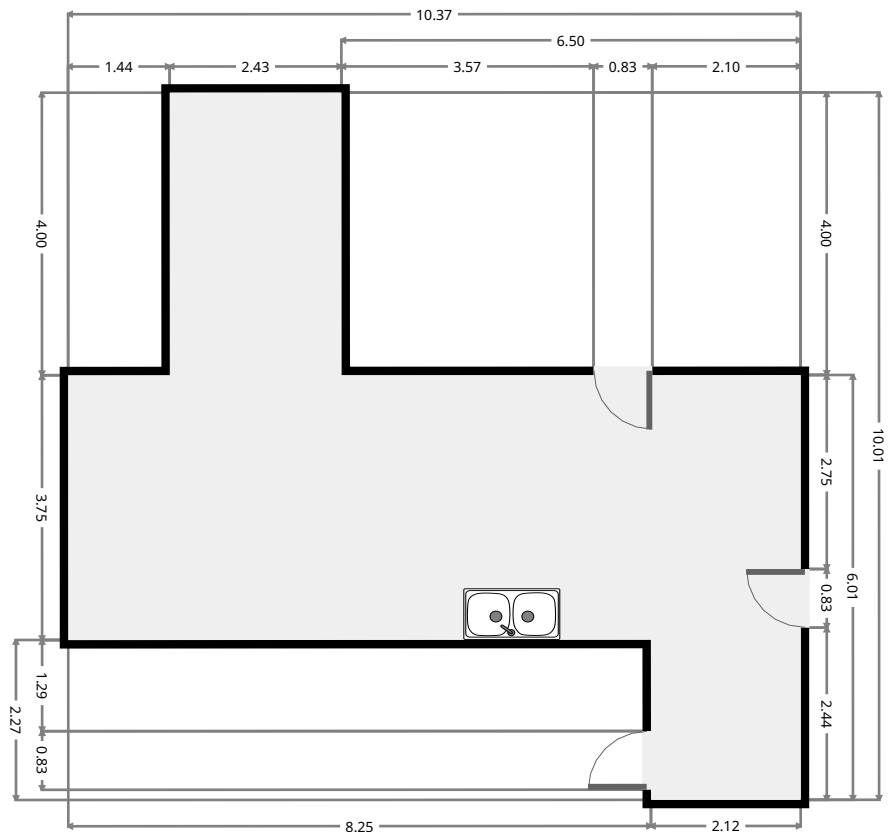
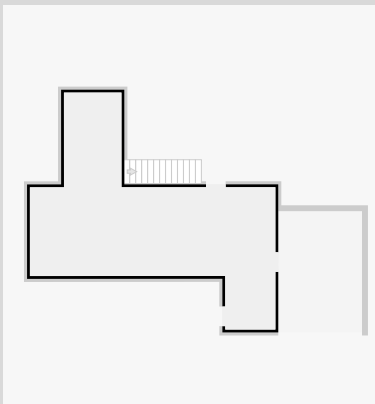

THIS FLOORPLAN IS PROVIDED WITHOUT WARRANTY OF ANY KIND. SENSOPIA DISCLAIMS ANY WARRANTY INCLUDING, WITHOUT LIMITATION, SATISFACTORY QUALITY OR ACCURACY OF DIMENSIONS.

81 Quarry Street

1st Floor

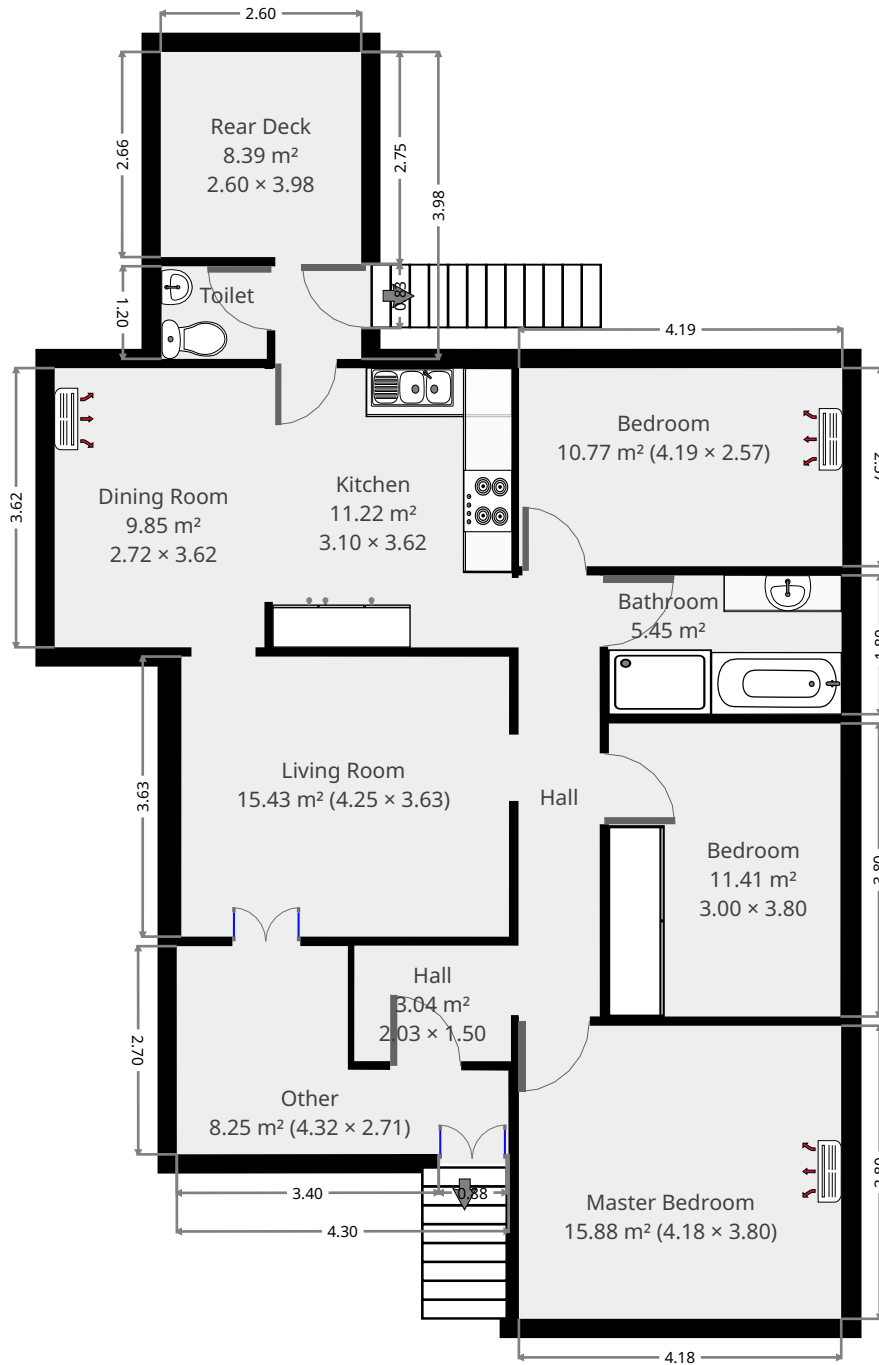

THIS FLOORPLAN IS PROVIDED WITHOUT WARRANTY OF ANY KIND. SENSOPIA DISCLAIMS ANY WARRANTY INCLUDING, WITHOUT LIMITATION, SATISFACTORY QUALITY OR ACCURACY OF DIMENSIONS.



81 Quarry Street

Living Room

Width: 3.63 m
 Length: 4.25 m
 Area: 15.43 m²
 Perimeter: 15.76 m

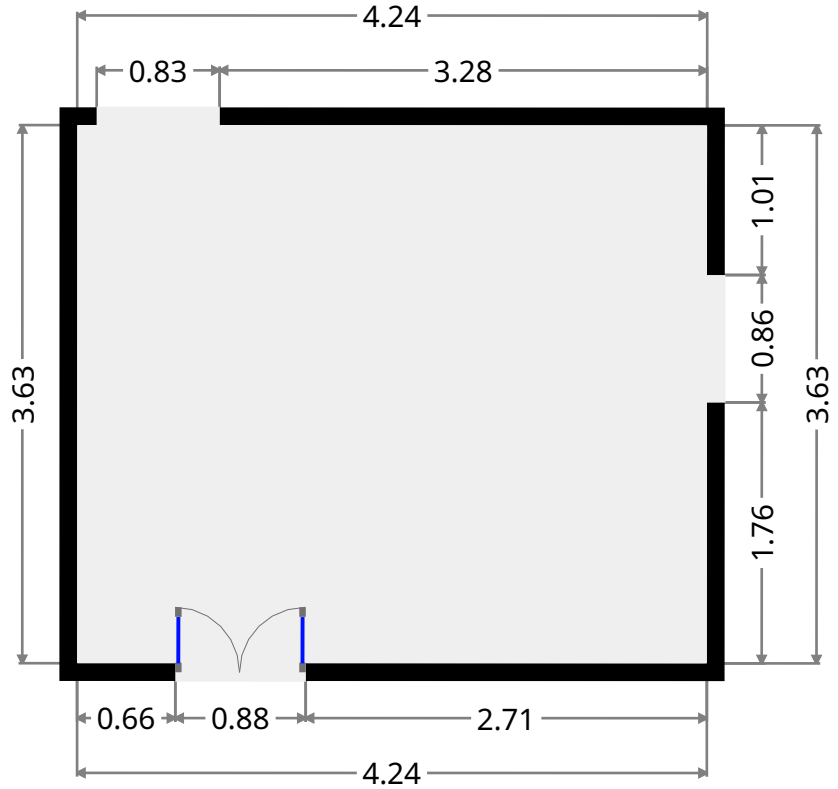
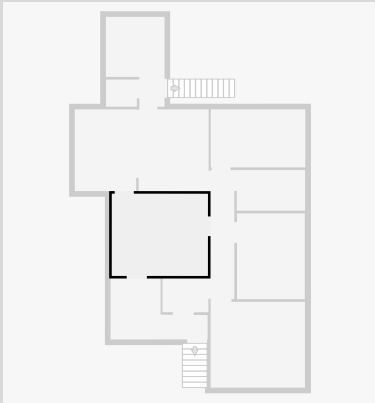

Other

Width: 2.71 m
 Length: 4.32 m
 Area: 8.25 m²
 Perimeter: 13.99 m

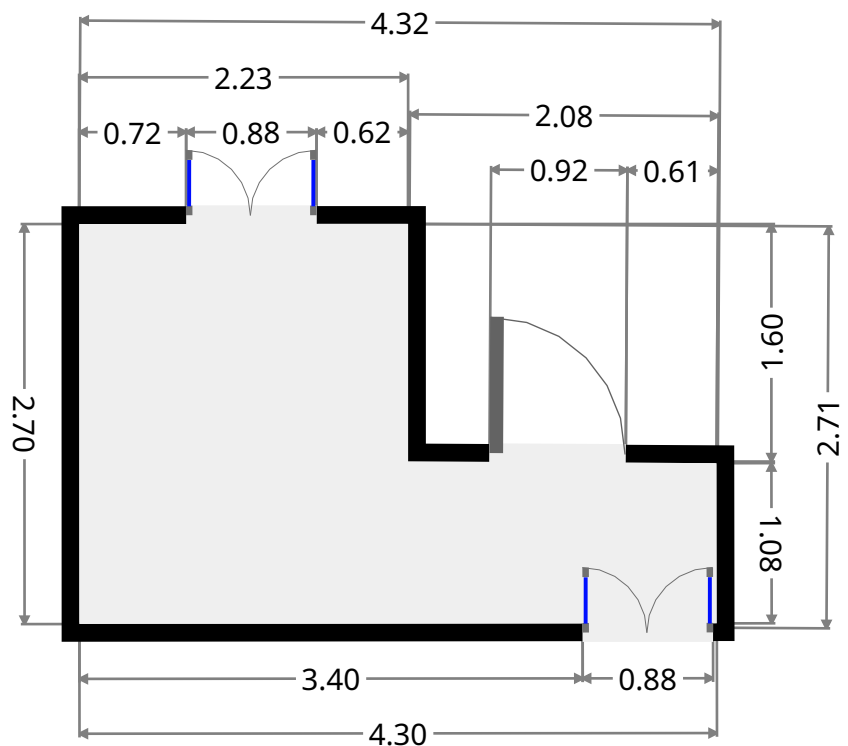
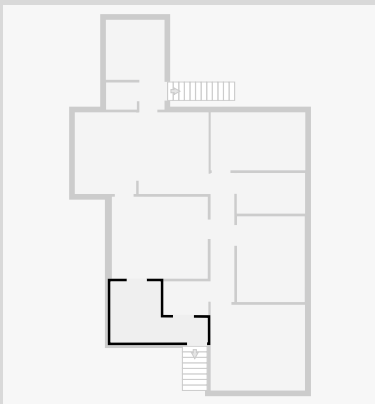

THIS FLOORPLAN IS PROVIDED WITHOUT WARRANTY OF ANY KIND. SENSOPIA DISCLAIMS ANY WARRANTY INCLUDING, WITHOUT LIMITATION, SATISFACTORY QUALITY OR ACCURACY OF DIMENSIONS.

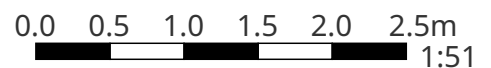

81 Quarry Street

Hall

Width: 1.50 m
Length: 2.03 m
Area: 3.04 m²
Perimeter: 7.06 m

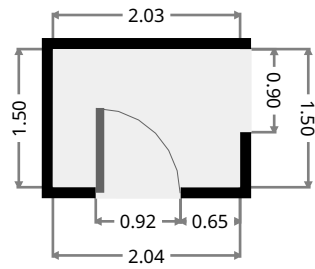
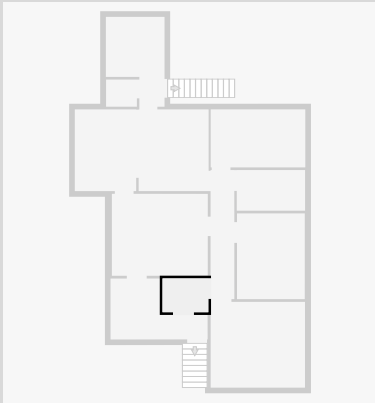

Hall

Width: 1.05 m
Length: 5.72 m
Area: 6.02 m²
Perimeter: 13.54 m

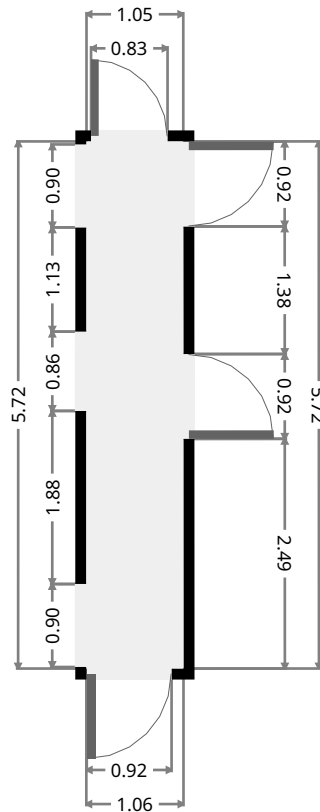
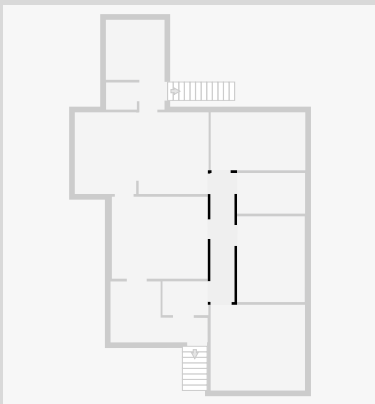

81 Quarry Street

Master Bedroom

Width: 3.80 m
 Length: 4.18 m
 Area: 15.88 m²
 Perimeter: 15.96 m

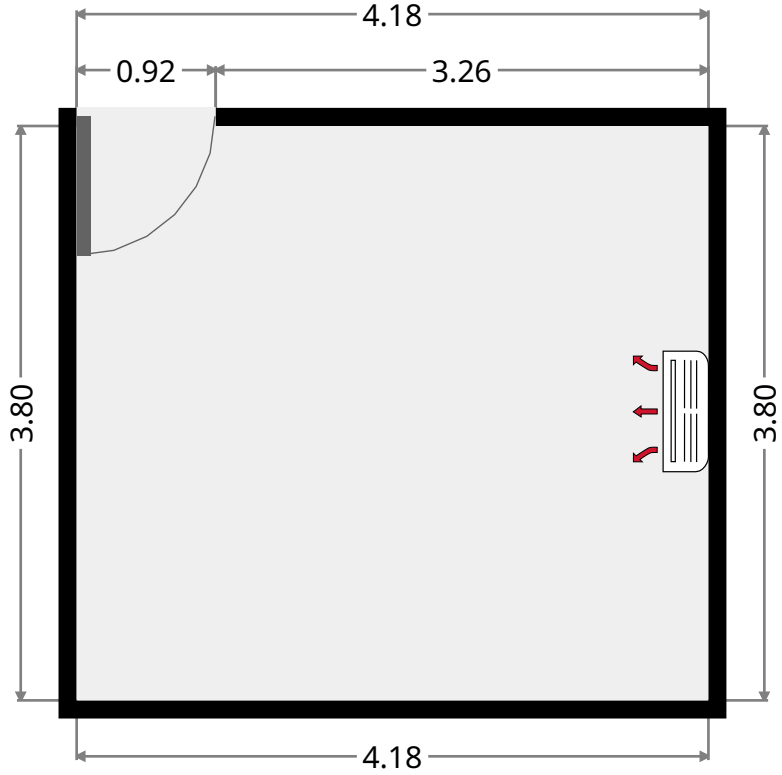
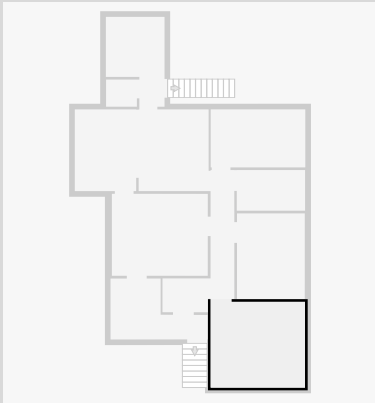

Bedroom

Width: 3.00 m
 Length: 3.80 m
 Area: 11.41 m²
 Perimeter: 13.61 m

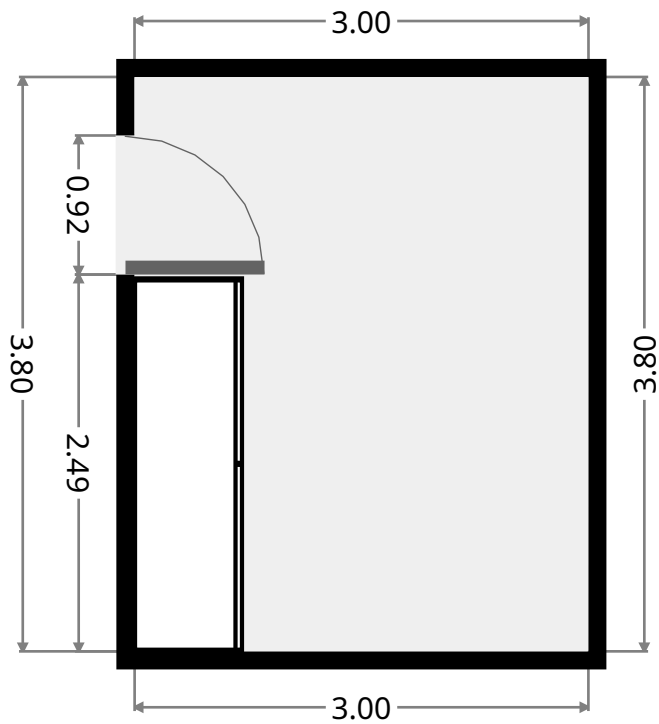
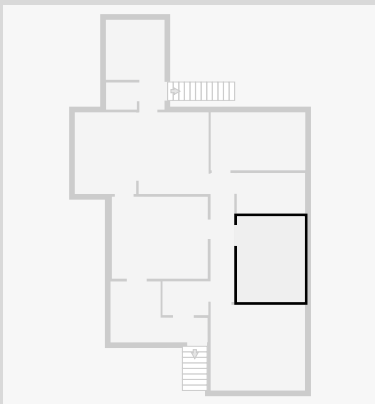

THIS FLOORPLAN IS PROVIDED WITHOUT WARRANTY OF ANY KIND. SENSOPIA DISCLAIMS ANY WARRANTY INCLUDING, WITHOUT LIMITATION, SATISFACTORY QUALITY OR ACCURACY OF DIMENSIONS.

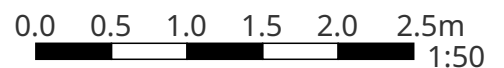

81 Quarry Street

Bathroom

Width: 1.80 m
Length: 3.03 m
Area: 5.45 m²
Perimeter: 9.66 m

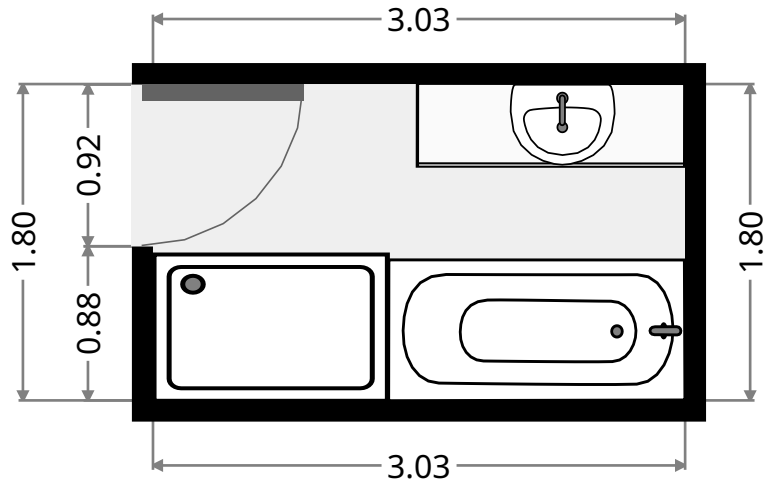
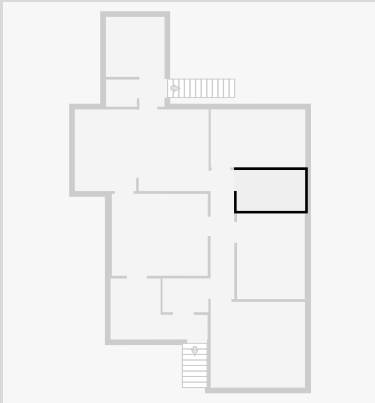

Bedroom

Width: 2.57 m
Length: 4.19 m
Area: 10.77 m²
Perimeter: 13.52 m

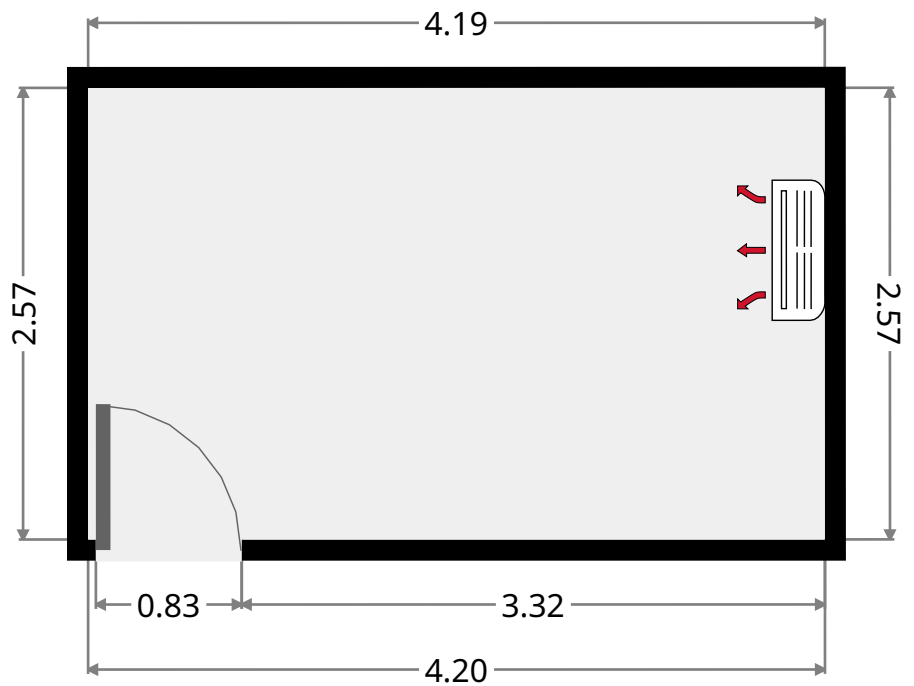
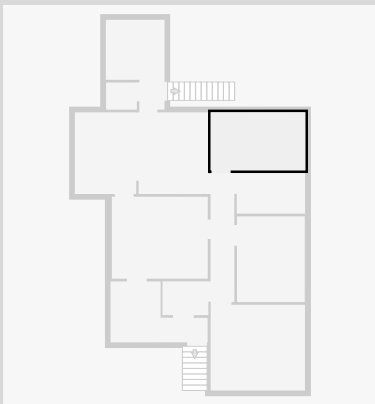

81 Quarry Street

Kitchen

Width: 3.10 m
 Length: 3.62 m
 Area: 11.22 m²
 Perimeter: 13.44 m

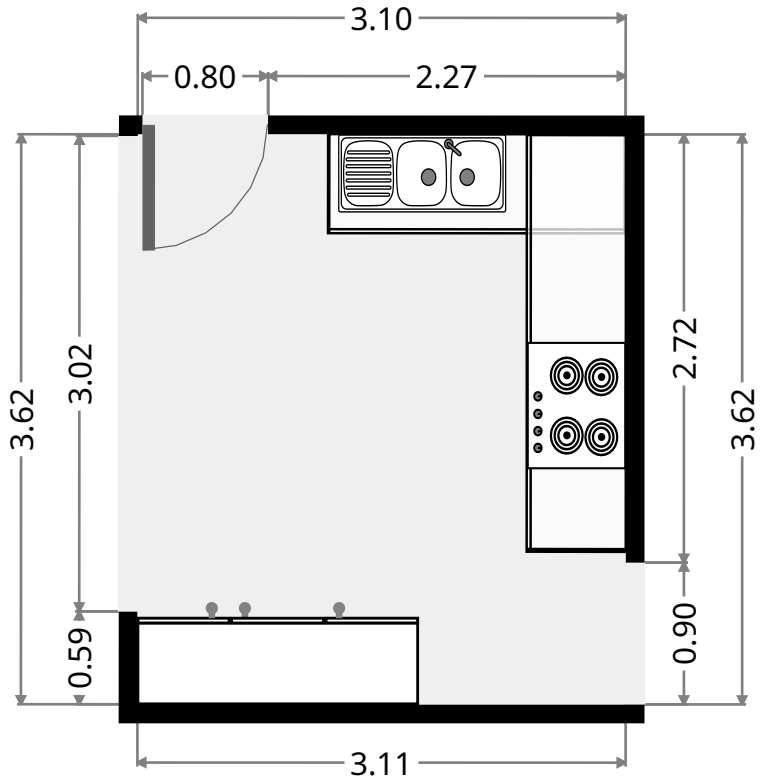
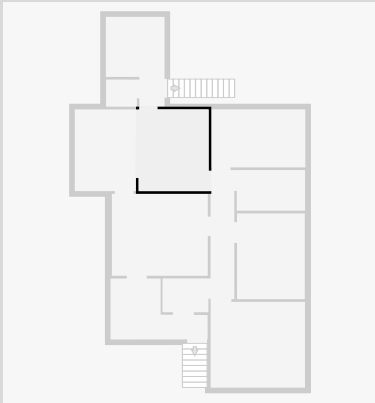

Dining Room

Width: 2.72 m
 Length: 3.62 m
 Area: 9.85 m²
 Perimeter: 12.68 m

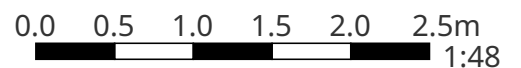
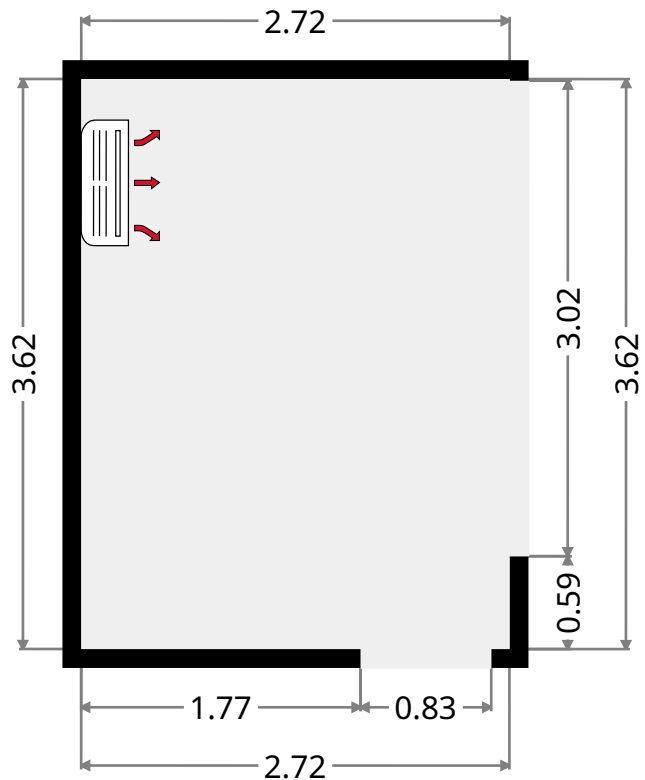
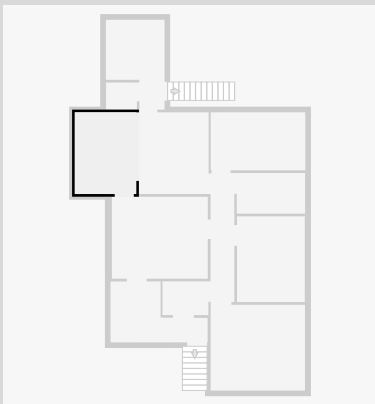

THIS FLOORPLAN IS PROVIDED WITHOUT WARRANTY OF ANY KIND. SENSOPIA DISCLAIMS ANY WARRANTY INCLUDING, WITHOUT LIMITATION, SATISFACTORY QUALITY OR ACCURACY OF DIMENSIONS.

81 Quarry Street

Rear Deck

Width: 2.60 m
 Length: 3.98 m
 Area: 8.39 m²
 Perimeter: 13.16 m

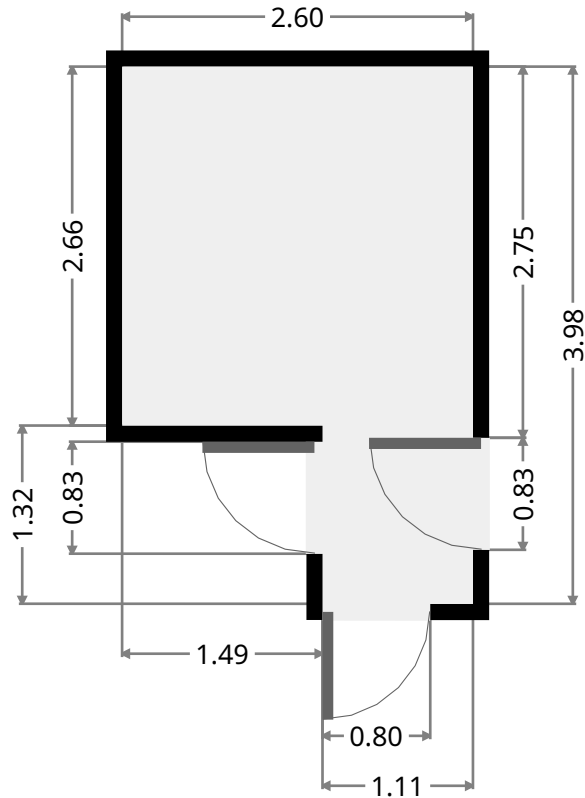
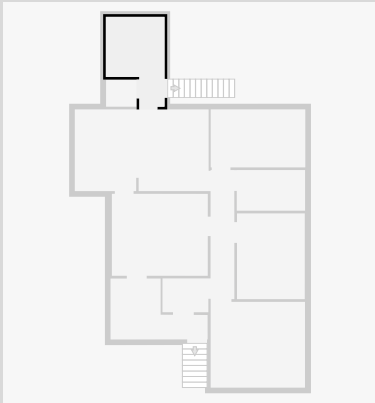

Toilet / Half Bath

Width: 1.20 m
 Length: 1.37 m
 Area: 1.64 m²
 Perimeter: 5.13 m

