

# 80 Keryn Drive

Created on  
2020-06-16

---

**Floors**  
1

---

---

# 80 Keryn Drive

FLOORS: 1

## ▼ Ground Floor

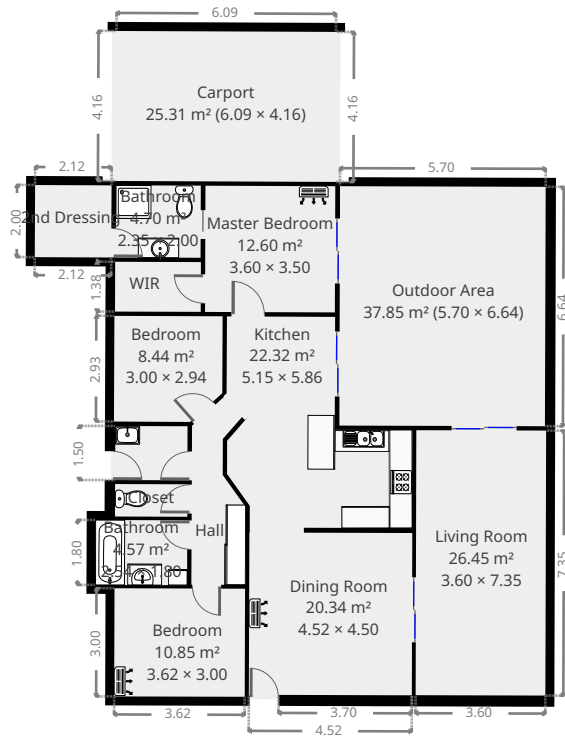

THIS FLOORPLAN IS PROVIDED WITHOUT WARRANTY OF ANY KIND. SENSOPIA DISCLAIMS ANY WARRANTY INCLUDING, WITHOUT LIMITATION, SATISFACTORY QUALITY OR ACCURACY OF DIMENSIONS.

# 80 Keryn Drive

FLOORS:1

## ▼ Dining Room Ground Floor

**WIDTH:** 4.52 m • **LENGTH:** 4.50 m  
**AREA:** 20.34 m<sup>2</sup> • **PERIMETER:** 18.04 m

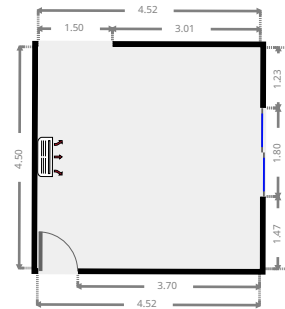
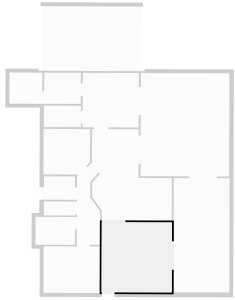

## ▼ Kitchen Ground Floor

**WIDTH:** 5.15 m • **LENGTH:** 5.86 m  
**AREA:** 22.32 m<sup>2</sup> • **PERIMETER:** 22.00 m

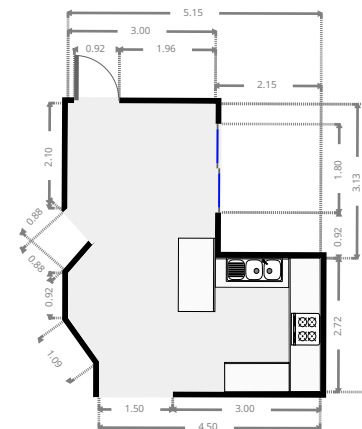
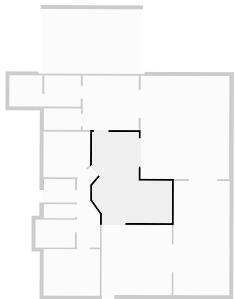

# 80 Keryn Drive

FLOORS:1

## ▼ Master Bedroom Ground Floor

WIDTH: 3.60 m • LENGTH: 3.50 m  
AREA: 12.60 m<sup>2</sup> • PERIMETER: 14.20 m

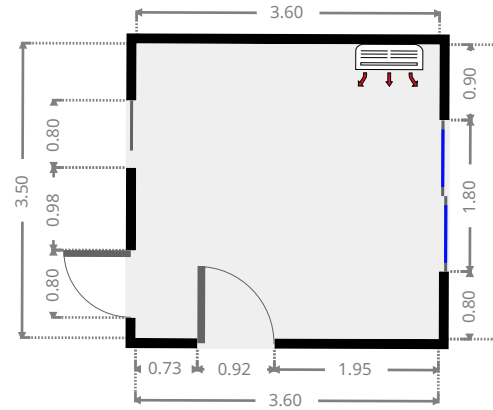
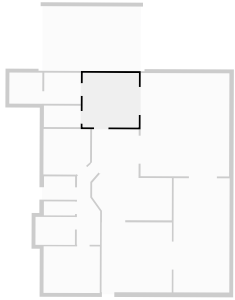

## ▼ Bathroom Ground Floor

WIDTH: 2.35 m • LENGTH: 2.00 m  
AREA: 4.70 m<sup>2</sup> • PERIMETER: 8.70 m

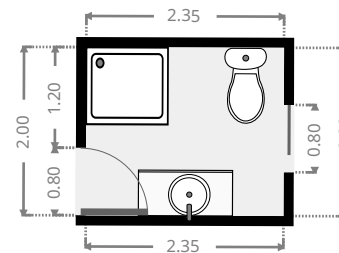
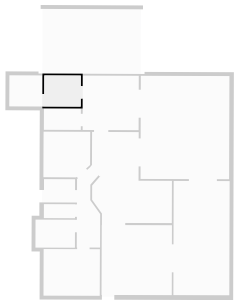

# 80 Keryn Drive

FLOORS:1

## ▼ WIR

Ground Floor

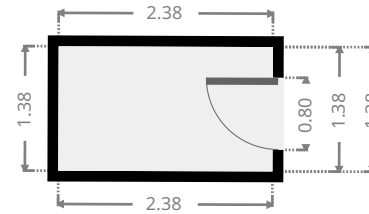
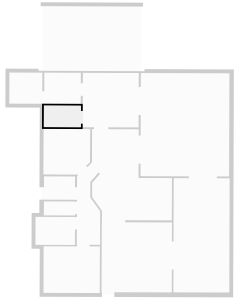

WIDTH: 2.38 m • LENGTH: 1.38 m  
AREA: 3.28 m<sup>2</sup> • PERIMETER: 7.51 m

## ▼ Bedroom

Ground Floor

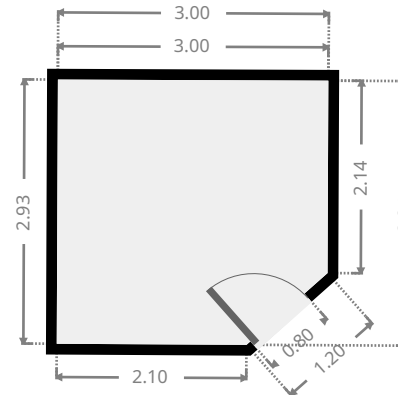
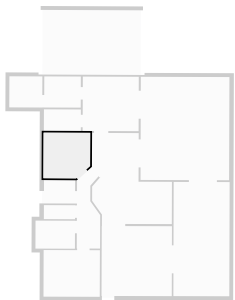

WIDTH: 3.00 m • LENGTH: 2.94 m  
AREA: 8.44 m<sup>2</sup> • PERIMETER: 11.37 m

# 80 Keryn Drive

FLOORS:1

## ▼ Hall Ground Floor

WIDTH: 1.50 m • LENGTH: 5.22 m  
AREA: 6.09 m<sup>2</sup> • PERIMETER: 12.91 m

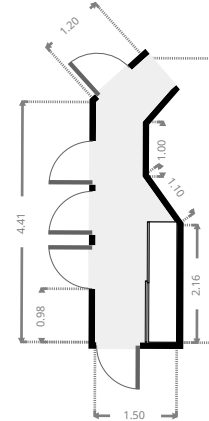
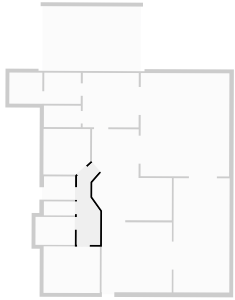

## ▼ Laundry Room Ground Floor

WIDTH: 2.00 m • LENGTH: 1.50 m  
AREA: 3.00 m<sup>2</sup> • PERIMETER: 7.00 m

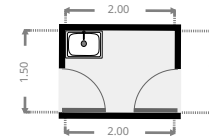
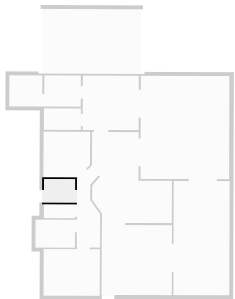

# 80 Keryn Drive

FLOORS:1

## ▼ Closet Ground Floor

WIDTH: 2.01 m • LENGTH: 0.90 m  
AREA: 1.80 m<sup>2</sup> • PERIMETER: 5.81 m

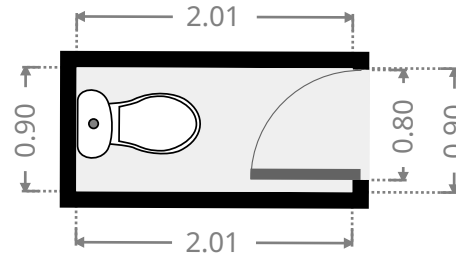
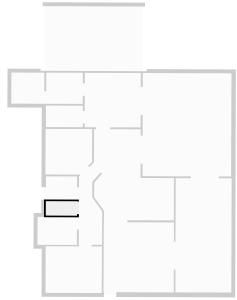

## ▼ Bathroom Ground Floor

WIDTH: 2.54 m • LENGTH: 1.80 m  
AREA: 4.57 m<sup>2</sup> • PERIMETER: 8.68 m

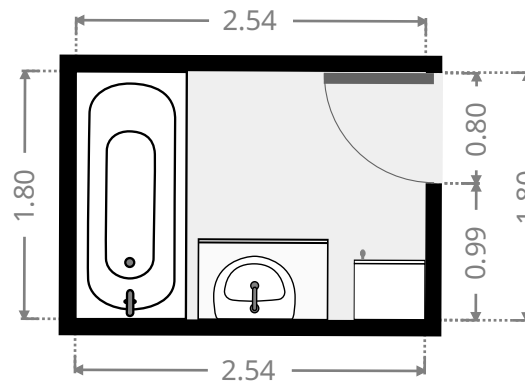
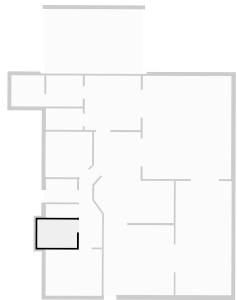

# 80 Keryn Drive

FLOORS:1

## ▼ Bedroom Ground Floor

WIDTH: 3.62 m • LENGTH: 3.00 m  
AREA: 10.85 m<sup>2</sup> • PERIMETER: 13.24 m

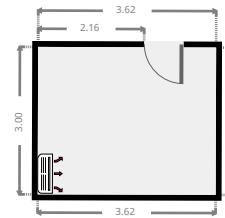

## ▼ Living Room Ground Floor

WIDTH: 3.60 m • LENGTH: 7.35 m  
AREA: 26.45 m<sup>2</sup> • PERIMETER: 21.90 m

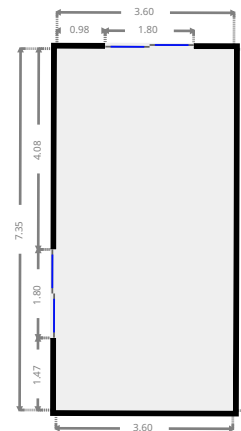
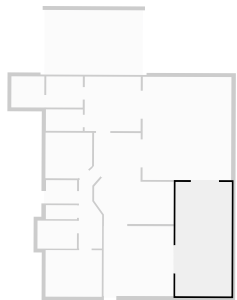



# 80 Keryn Drive

FLOORS:1

## ▼ Outdoor Area Ground Floor

**WIDTH:** 5.70 m • **LENGTH:** 6.64 m  
**AREA:** 37.85 m<sup>2</sup> • **PERIMETER:** 24.68 m

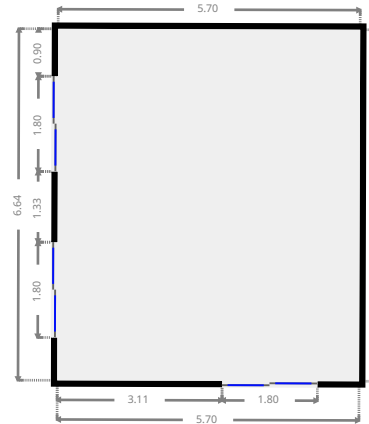
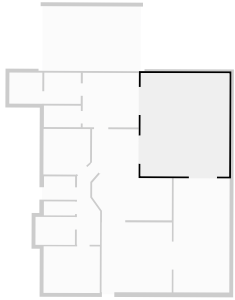

## ▼ Carport Ground Floor

**WIDTH:** 6.09 m • **LENGTH:** 4.16 m  
**AREA:** 25.31 m<sup>2</sup> • **PERIMETER:** 20.49 m

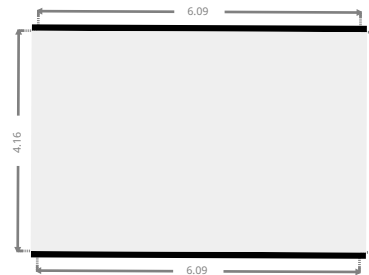
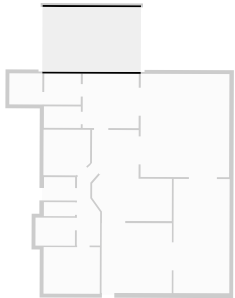

# 80 Keryn Drive

FLOORS:1

## ▼ 2nd Dressing Ground Floor

WIDTH: 2.12 m • LENGTH: 2.00 m  
AREA: 4.24 m<sup>2</sup> • PERIMETER: 8.24 m

