

# 80 Jessie Street

Created on  
2021-08-26

Floors  
2

▼ Ground Floor

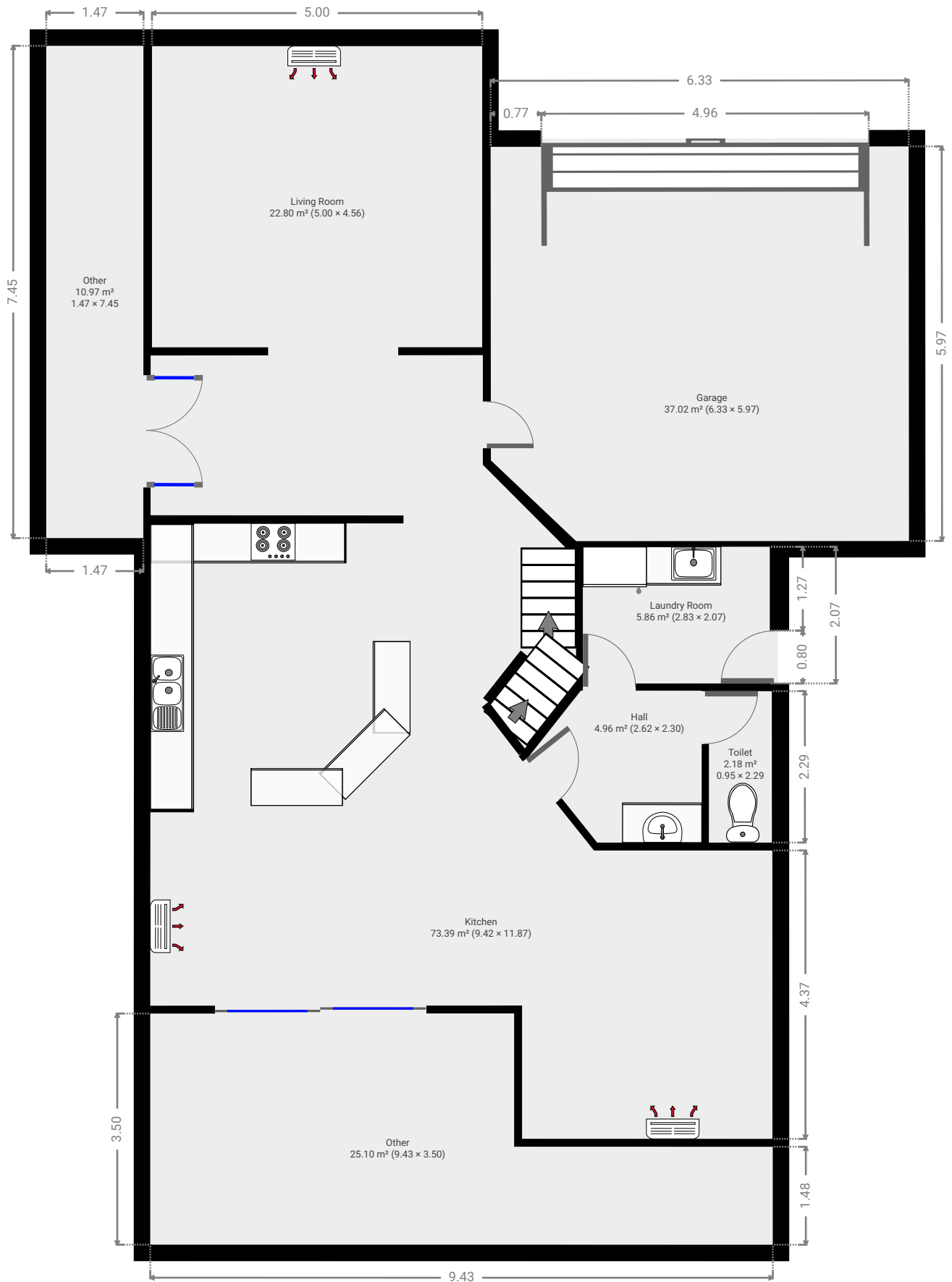

▼ Living Room  
Ground Floor

WIDTH: 4.56 m • LENGTH: 5.00 m  
AREA: 22.80 m<sup>2</sup> • PERIMETER: 19.12 m

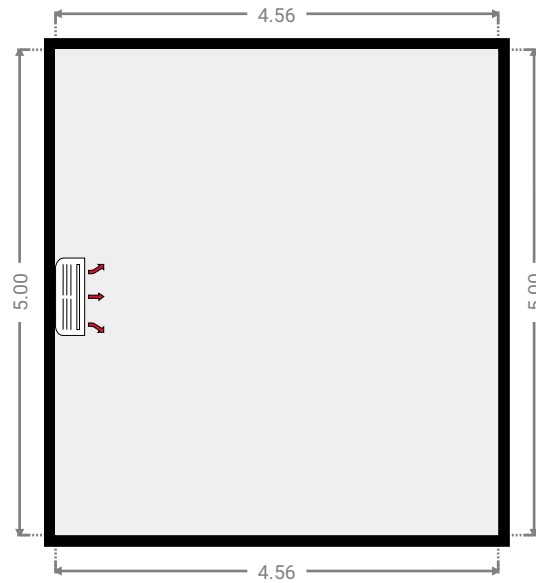
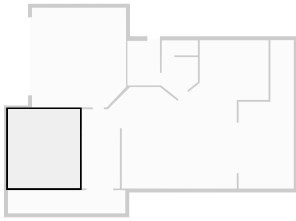

▼ Garage  
Ground Floor

WIDTH: 5.98 m • LENGTH: 6.33 m  
AREA: 37.02 m<sup>2</sup> • PERIMETER: 23.87 m

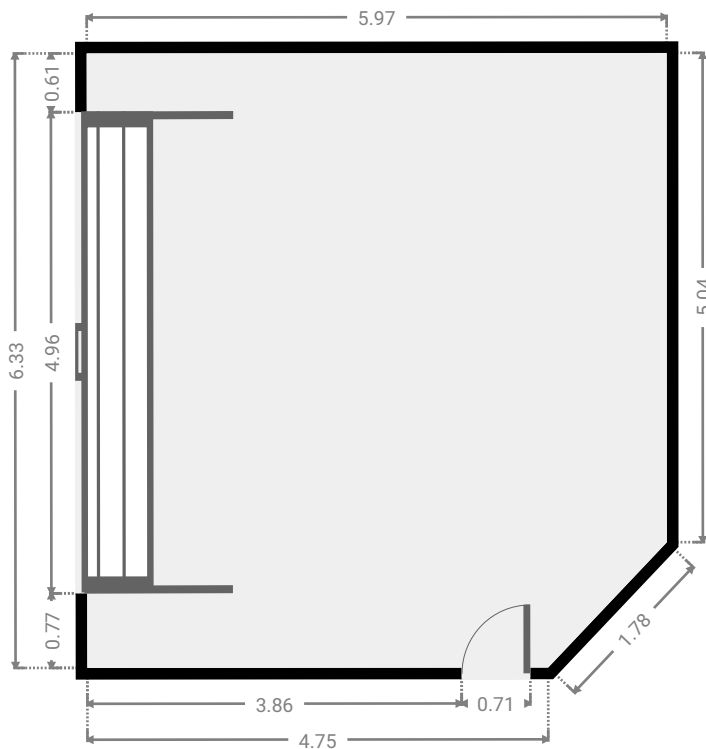
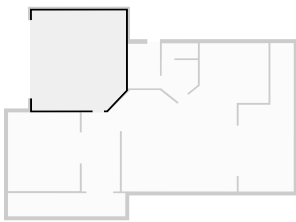

▼ **Kitchen**  
Ground Floor

WIDTH: 11.93 m • LENGTH: 9.43 m  
AREA: 73.39 m<sup>2</sup> • PERIMETER: 49.83 m

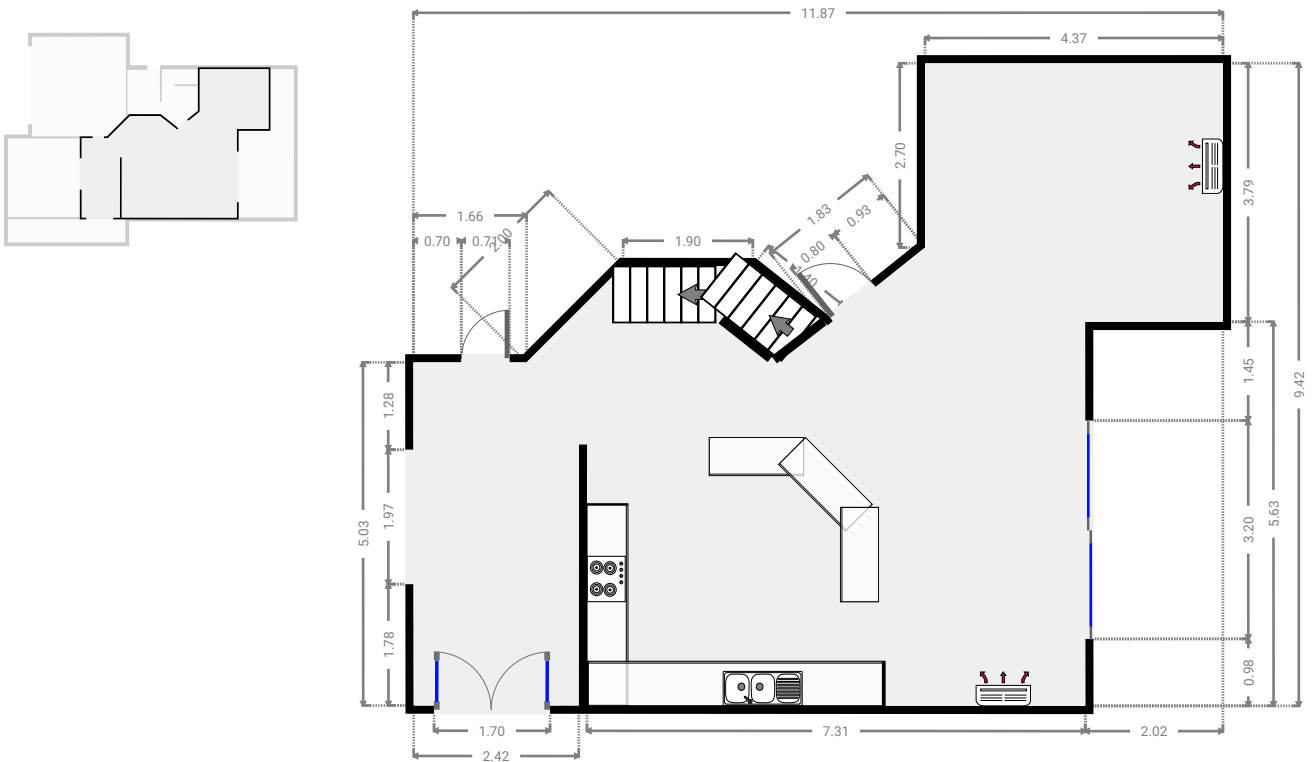

▼ **Hall**  
Ground Floor

WIDTH: 2.30 m • LENGTH: 2.61 m  
AREA: 4.96 m<sup>2</sup> • PERIMETER: 8.65 m

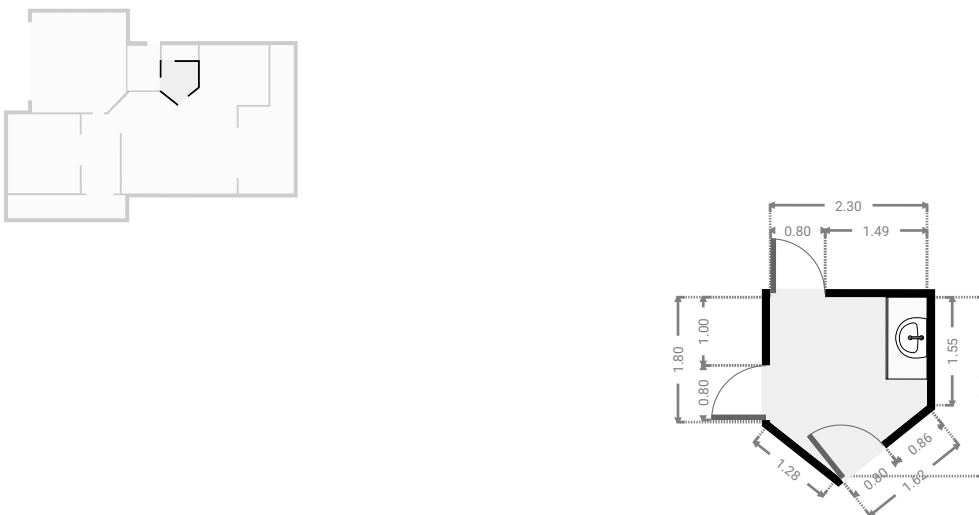

▼ Laundry Room  
Ground Floor

WIDTH: 2.07 m • LENGTH: 2.83 m  
AREA: 5.86 m<sup>2</sup> • PERIMETER: 9.80 m

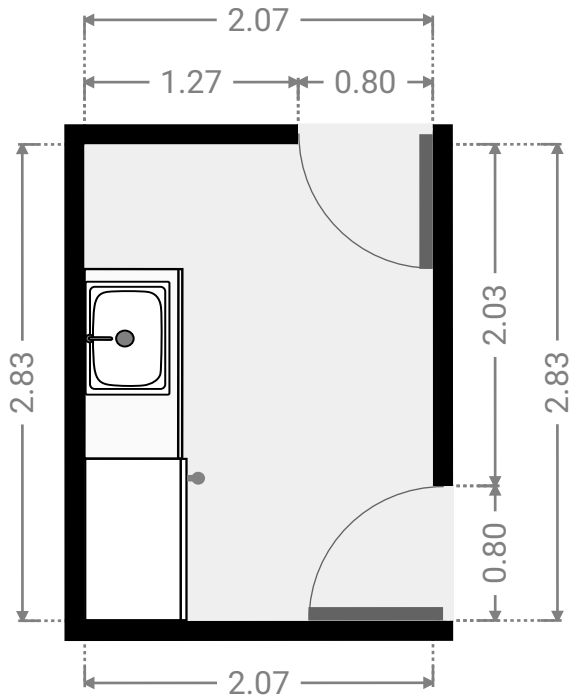
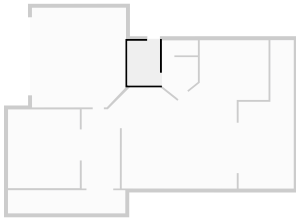

▼ Toilet  
Ground Floor

WIDTH: 2.29 m • LENGTH: 0.95 m  
AREA: 2.18 m<sup>2</sup> • PERIMETER: 6.49 m

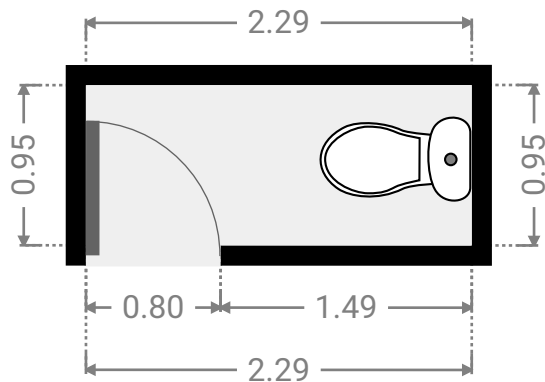
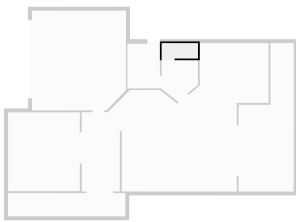

▼ Other  
Ground Floor

WIDTH: 3.50 m • LENGTH: 9.43 m  
AREA: 25.10 m<sup>2</sup> • PERIMETER: 25.86 m

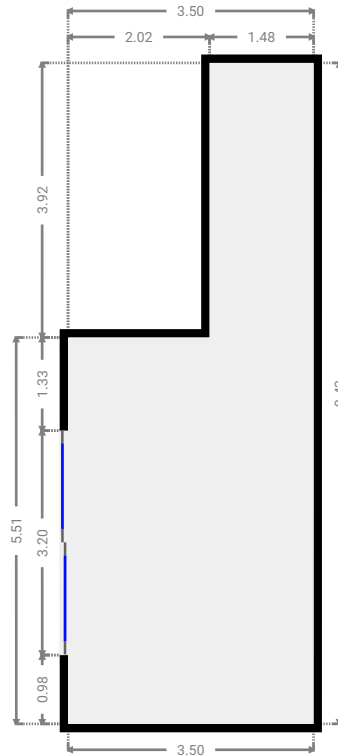
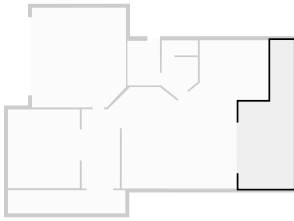

▼ Other  
Ground Floor

WIDTH: 7.45 m • LENGTH: 1.47 m  
AREA: 10.97 m<sup>2</sup> • PERIMETER: 17.85 m

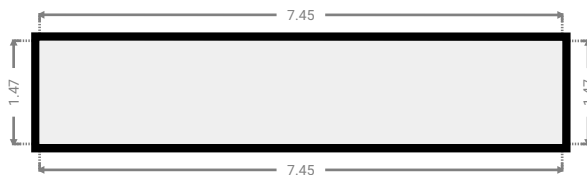
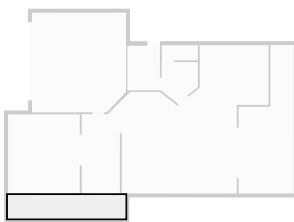

▼ 1st Floor

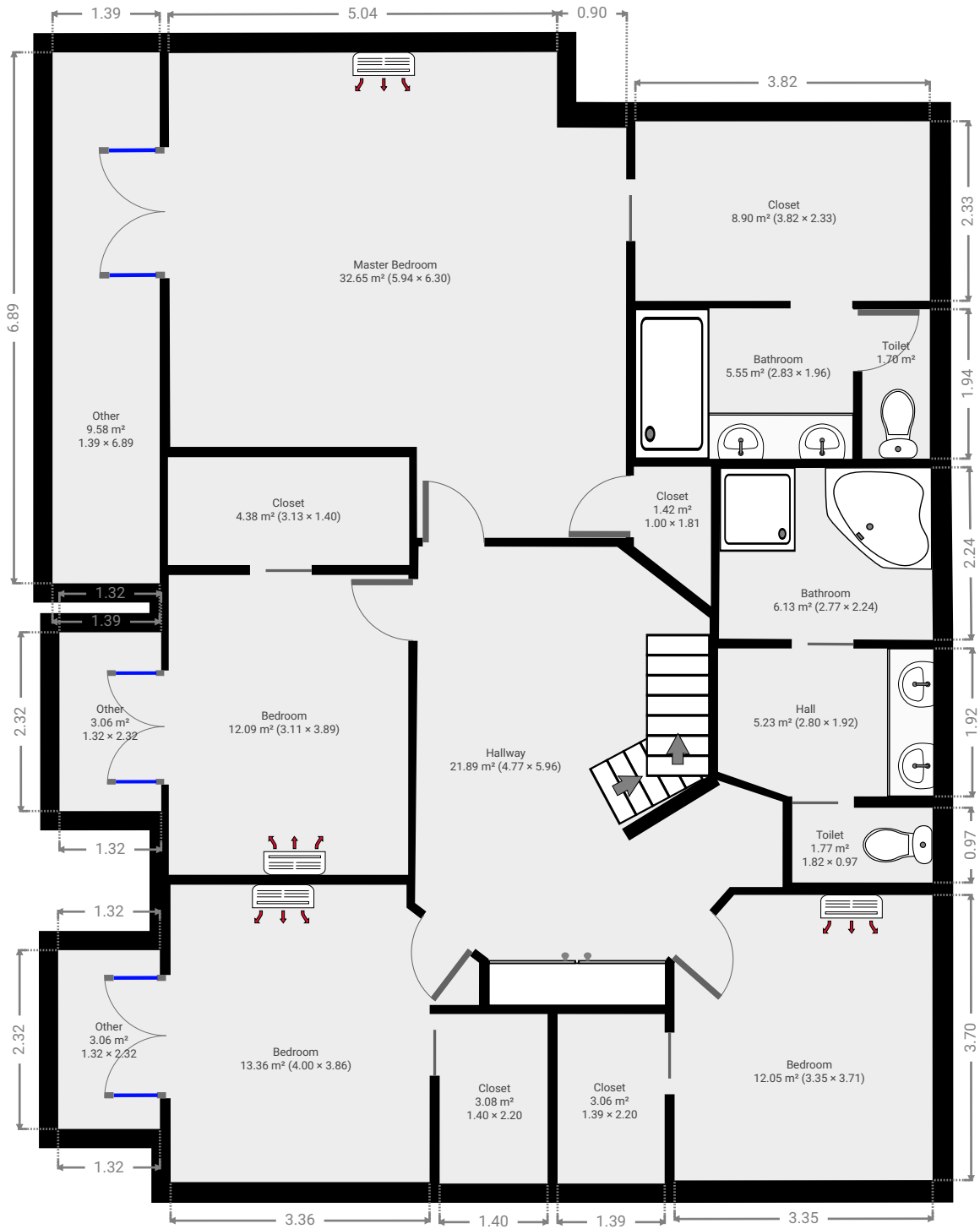

▼ **Hallway**  
1st Floor

WIDTH: 5.96 m • LENGTH: 4.77 m  
AREA: 21.89 m<sup>2</sup> • PERIMETER: 19.53 m

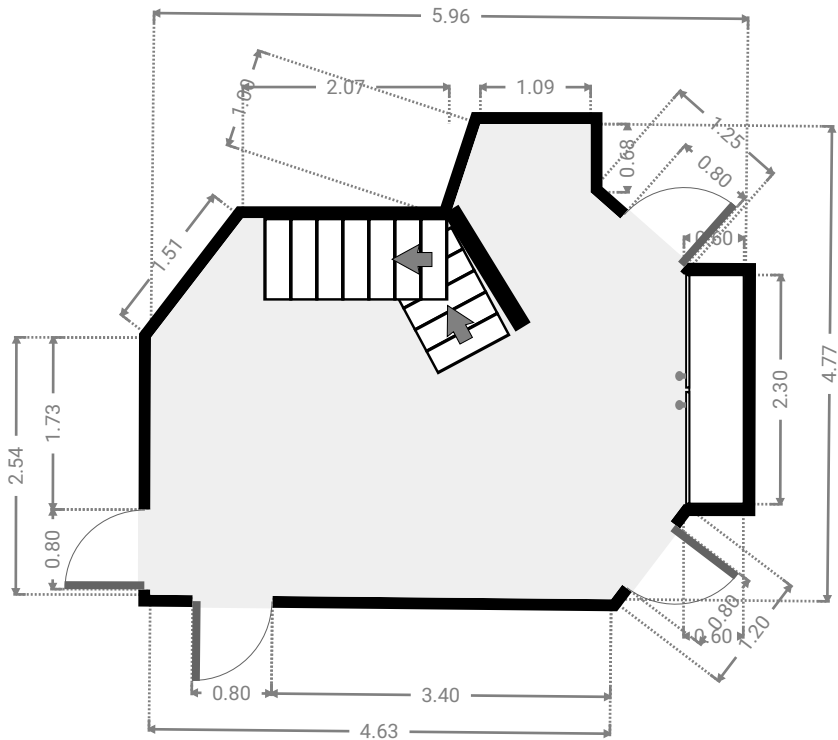
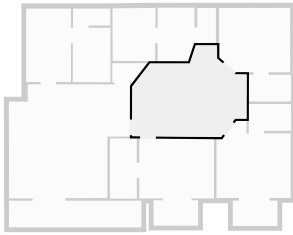

▼ **Bathroom**  
1st Floor

WIDTH: 2.24 m • LENGTH: 2.77 m  
AREA: 6.13 m<sup>2</sup> • PERIMETER: 9.96 m

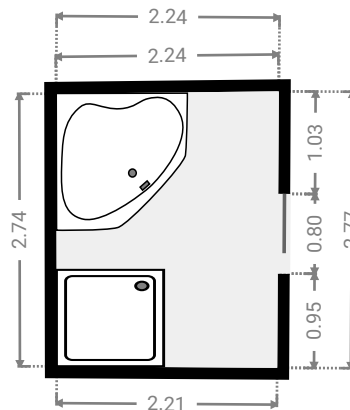
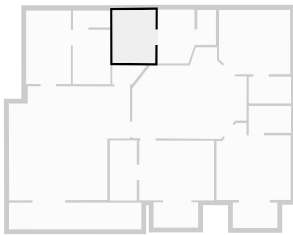



▼ **Hall**  
1st Floor

WIDTH: 1.92 m • LENGTH: 2.80 m  
AREA: 5.23 m<sup>2</sup> • PERIMETER: 9.17 m

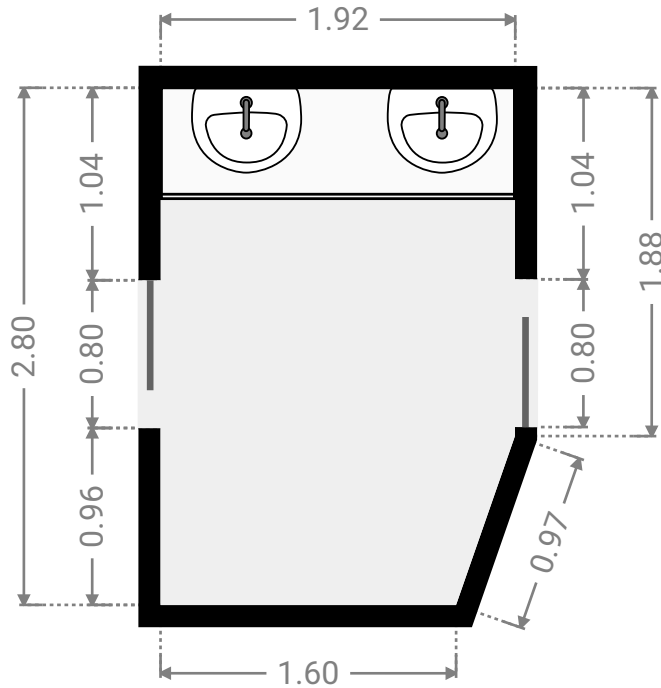
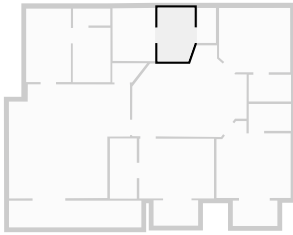

▼ **Toilet**  
1st Floor

WIDTH: 0.97 m • LENGTH: 1.82 m  
AREA: 1.77 m<sup>2</sup> • PERIMETER: 5.58 m

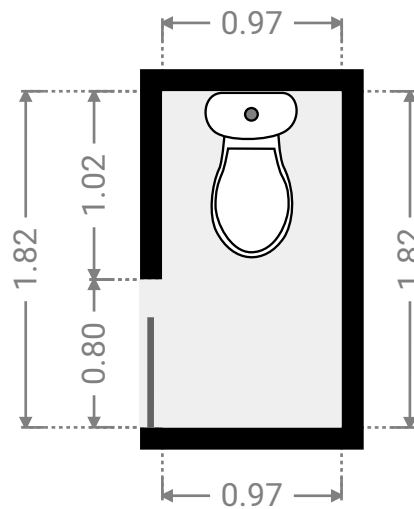
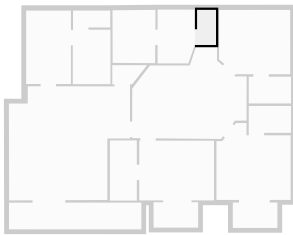

▼ **Bedroom**  
1st Floor

WIDTH: 3.71 m • LENGTH: 3.35 m  
AREA: 12.05 m<sup>2</sup> • PERIMETER: 13.62 m

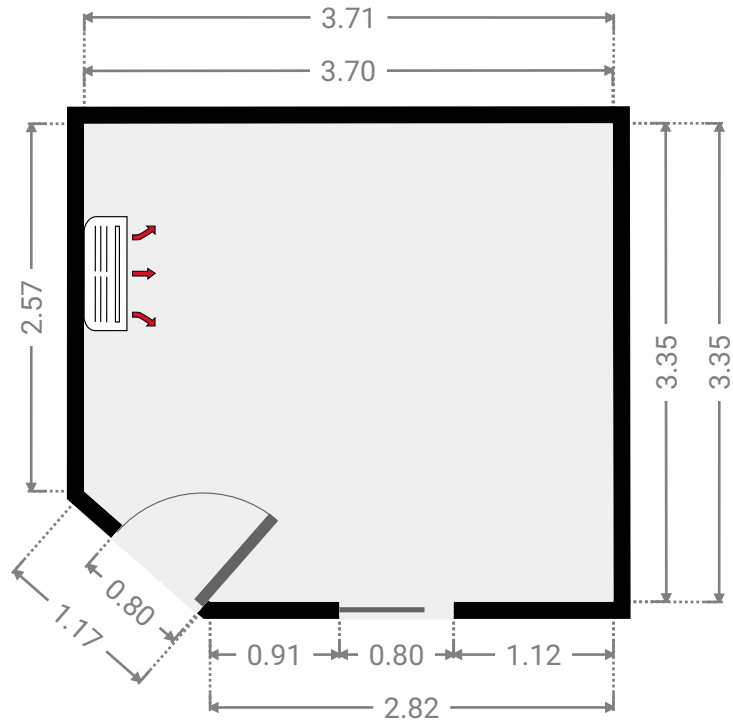
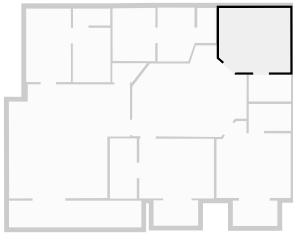

▼ **Closet**  
1st Floor

WIDTH: 2.20 m • LENGTH: 1.39 m  
AREA: 3.06 m<sup>2</sup> • PERIMETER: 7.18 m

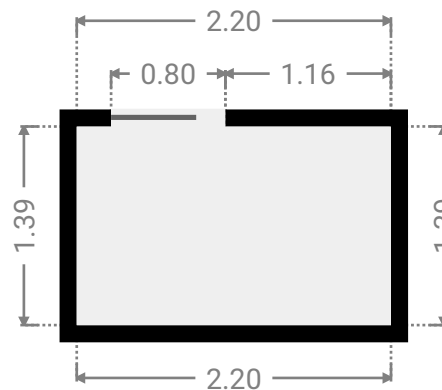
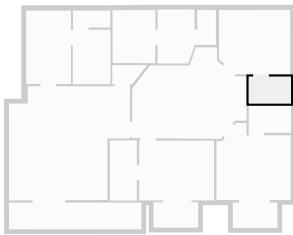

▼ **Closet**  
1st Floor

WIDTH: 2.20 m • LENGTH: 1.40 m  
AREA: 3.08 m<sup>2</sup> • PERIMETER: 7.20 m

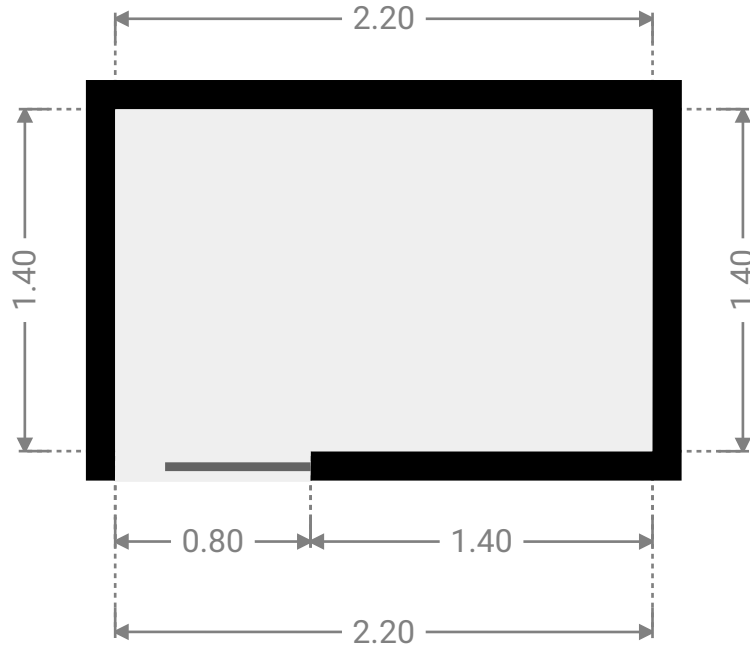
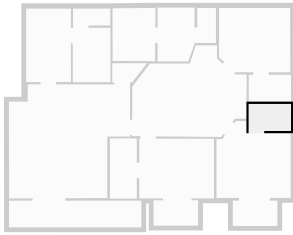

▼ **Other**  
1st Floor

WIDTH: 2.32 m • LENGTH: 1.32 m  
AREA: 3.06 m<sup>2</sup> • PERIMETER: 7.28 m

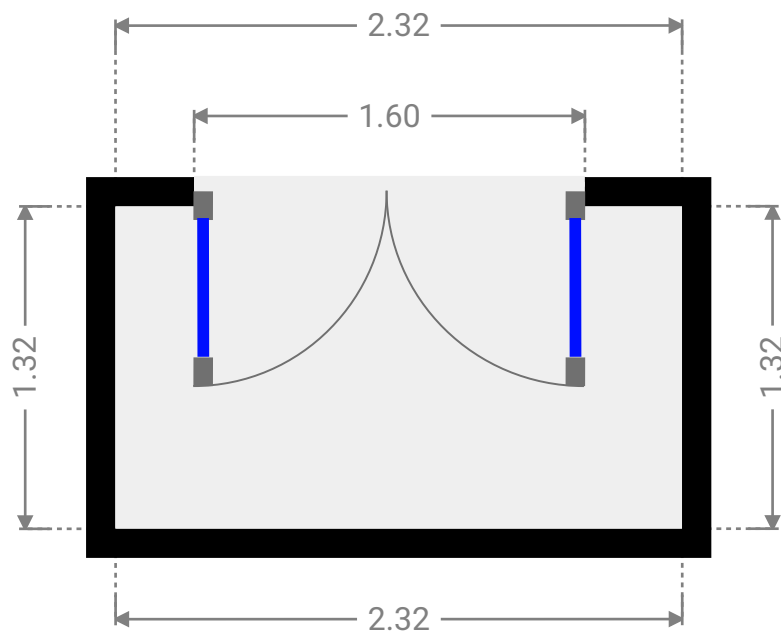
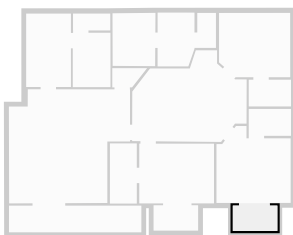

▼ **Bedroom**  
1st Floor

WIDTH: 3.86 m • LENGTH: 4.00 m  
AREA: 13.36 m<sup>2</sup> • PERIMETER: 15.25 m

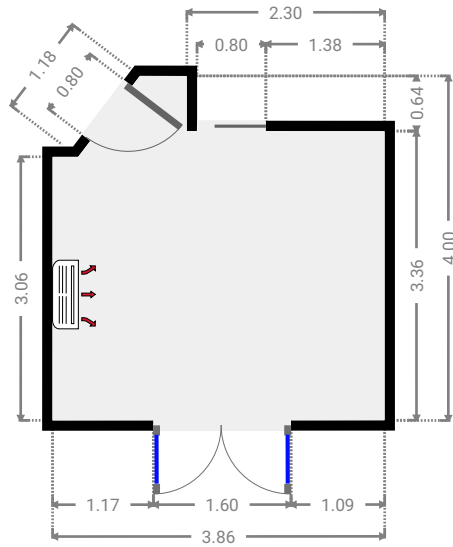
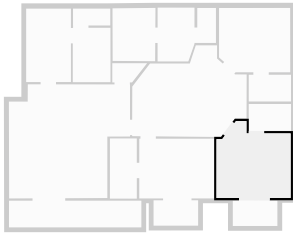

▼ **Master Bedroom**  
1st Floor

WIDTH: 6.30 m • LENGTH: 5.94 m  
AREA: 32.65 m<sup>2</sup> • PERIMETER: 24.44 m

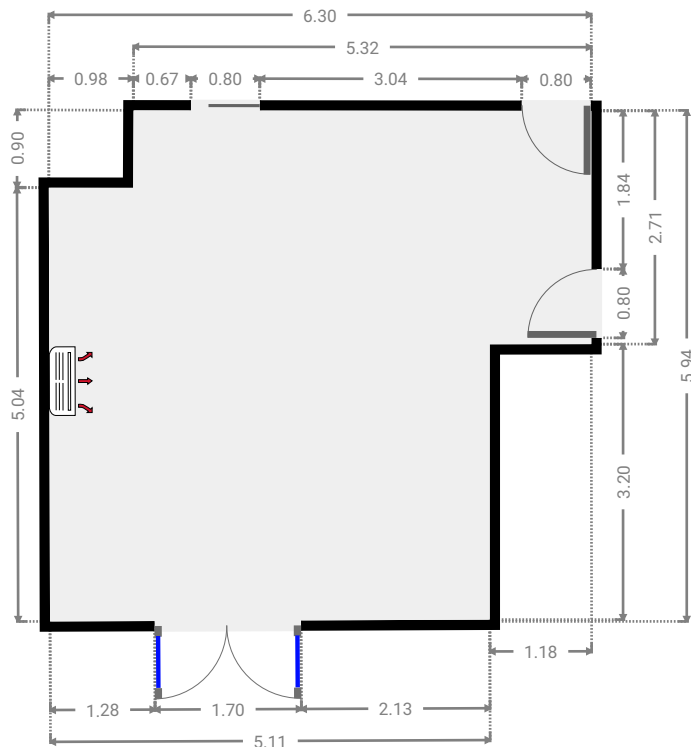
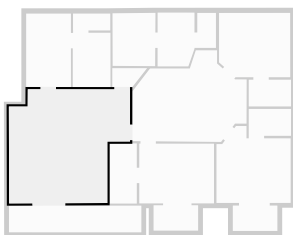

▼ Other  
1st Floor

WIDTH: 2.32 m • LENGTH: 1.32 m  
AREA: 3.06 m<sup>2</sup> • PERIMETER: 7.28 m

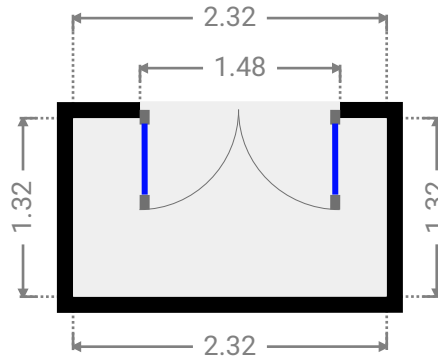
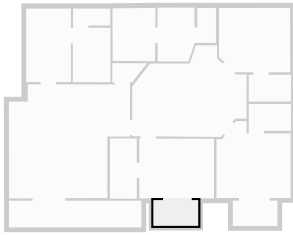

▼ Bedroom  
1st Floor

WIDTH: 3.89 m • LENGTH: 3.11 m  
AREA: 12.09 m<sup>2</sup> • PERIMETER: 14.00 m

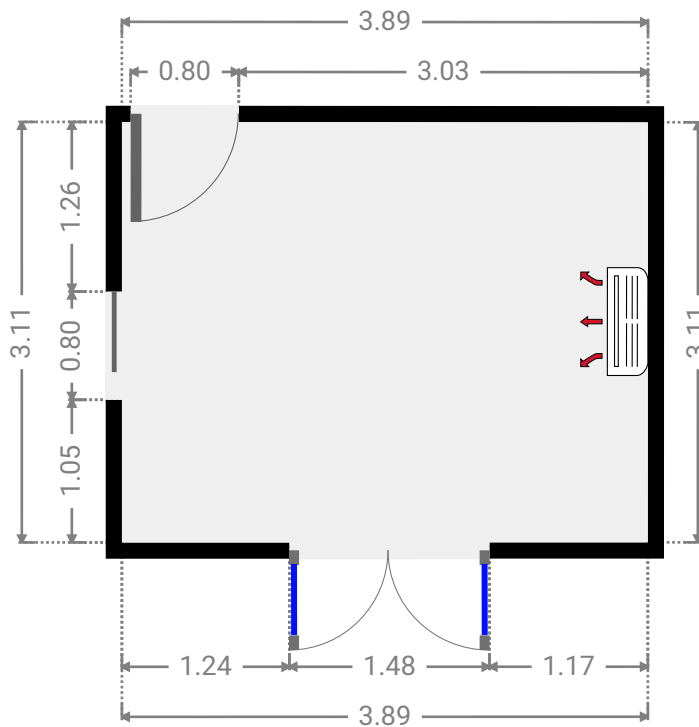
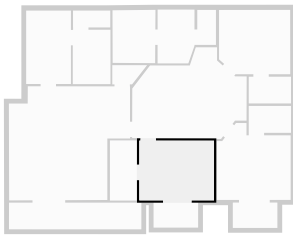

▼ **Closet**  
1st Floor

WIDTH: 1.40 m • LENGTH: 3.13 m  
AREA: 4.38 m<sup>2</sup> • PERIMETER: 9.06 m

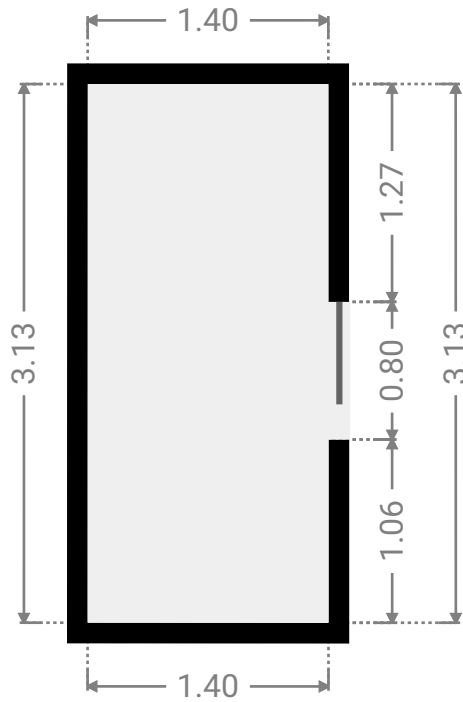
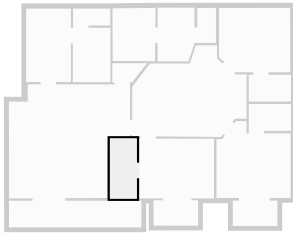

▼ **Toilet**  
1st Floor

WIDTH: 1.94 m • LENGTH: 0.88 m  
AREA: 1.70 m<sup>2</sup> • PERIMETER: 5.63 m

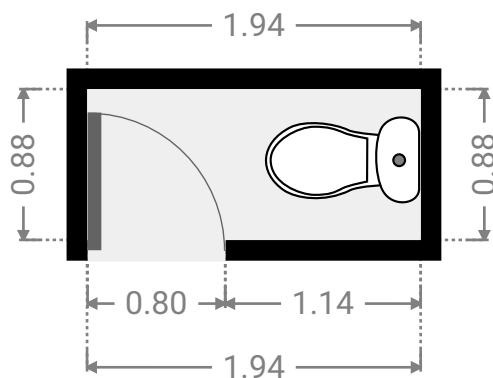
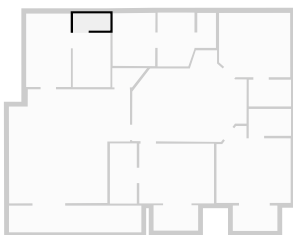

▼ Bathroom  
1st Floor

WIDTH: 1.96 m • LENGTH: 2.83 m  
AREA: 5.55 m<sup>2</sup> • PERIMETER: 9.58 m

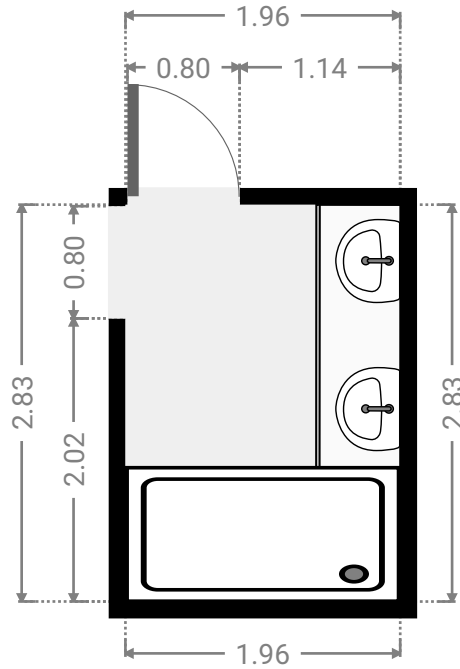
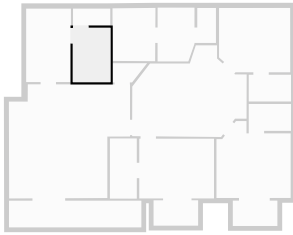

▼ Closet  
1st Floor

WIDTH: 2.33 m • LENGTH: 3.82 m  
AREA: 8.90 m<sup>2</sup> • PERIMETER: 12.30 m

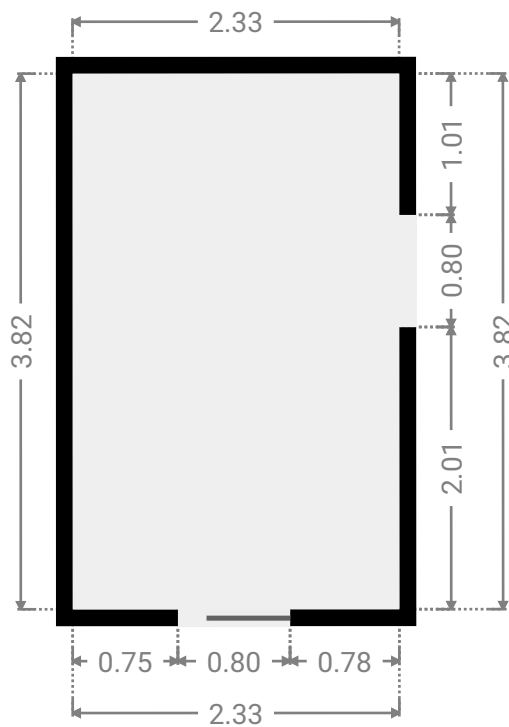
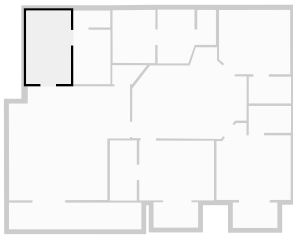

▼ Closet  
1st Floor

WIDTH: 1.81 m • LENGTH: 1.00 m  
AREA: 1.42 m<sup>2</sup> • PERIMETER: 5.11 m

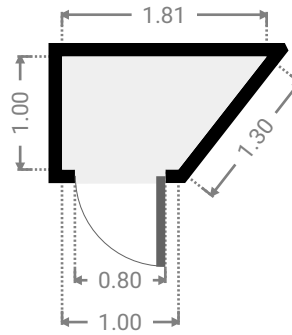
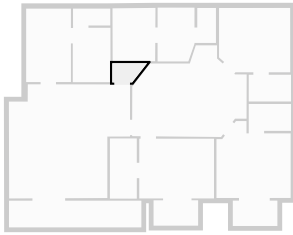

▼ Other  
1st Floor

WIDTH: 6.89 m • LENGTH: 1.39 m  
AREA: 9.58 m<sup>2</sup> • PERIMETER: 16.56 m

