

# 8 Rainbow Court

## Ground Floor

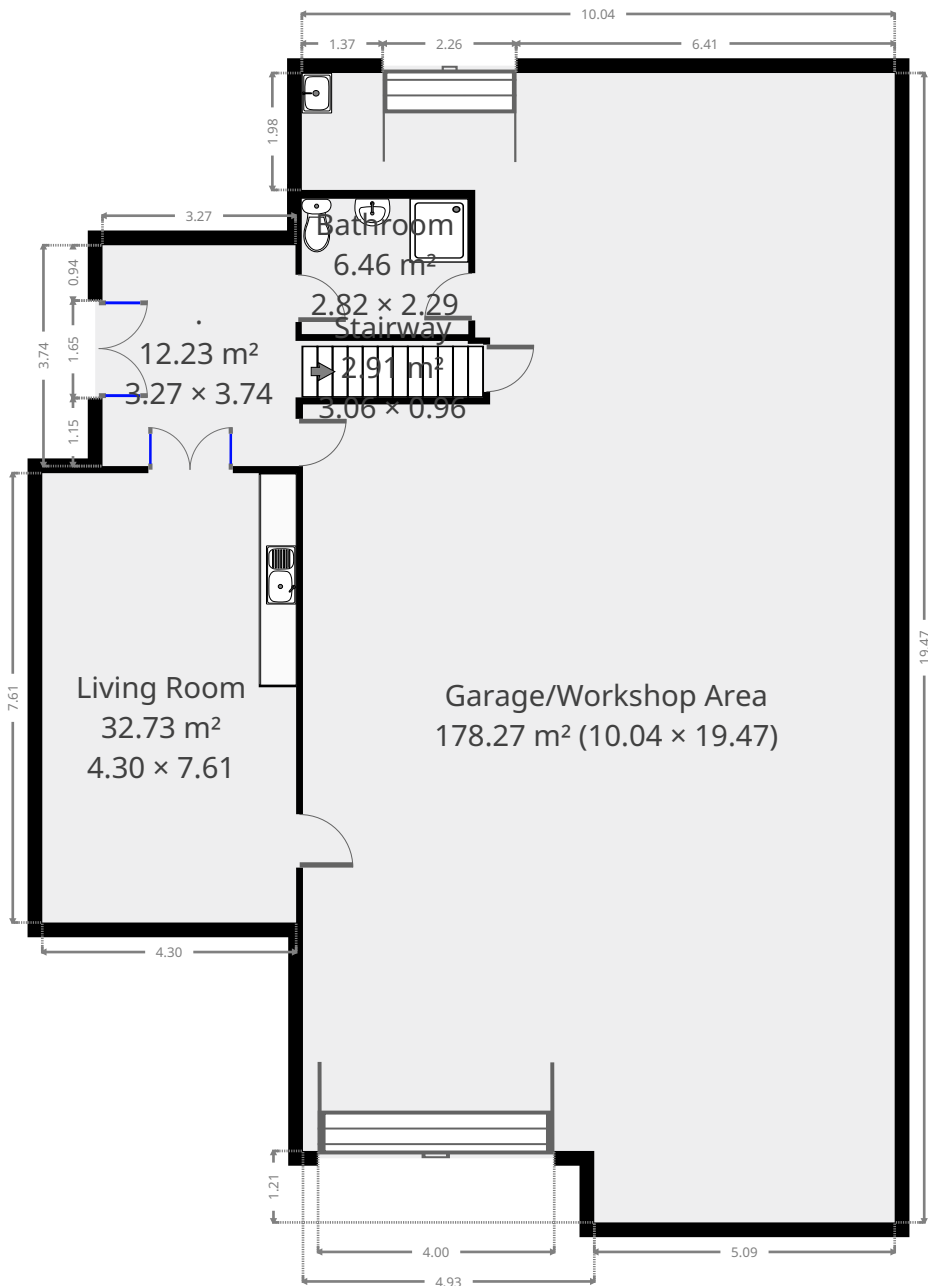

THIS FLOORPLAN IS PROVIDED WITHOUT WARRANTY OF ANY KIND. SENSOPIA DISCLAIMS ANY WARRANTY INCLUDING, WITHOUT LIMITATION, SATISFACTORY QUALITY OR ACCURACY OF DIMENSIONS.



# 8 Rainbow Court

Width: 3.27 m  
 Length: 3.74 m  
 Area: 12.23 m<sup>2</sup>  
 Perimeter: 14.02 m

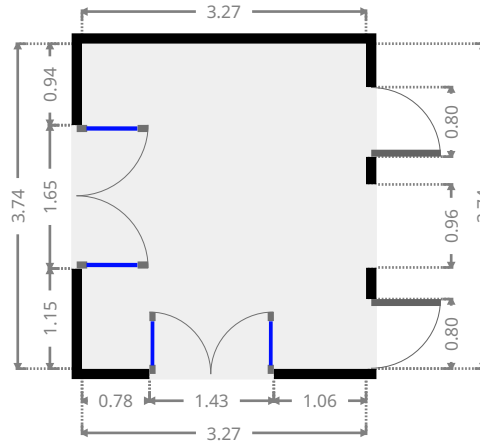
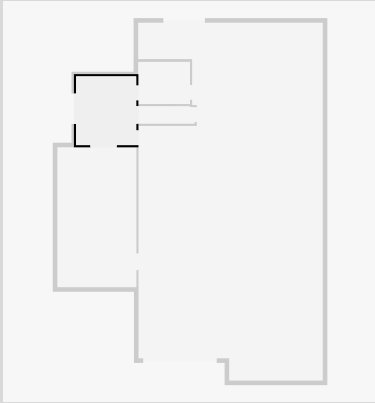

## Living Room

Width: 4.30 m  
 Length: 7.61 m  
 Area: 32.73 m<sup>2</sup>  
 Perimeter: 23.82 m

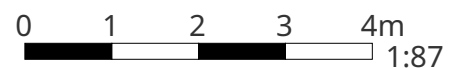
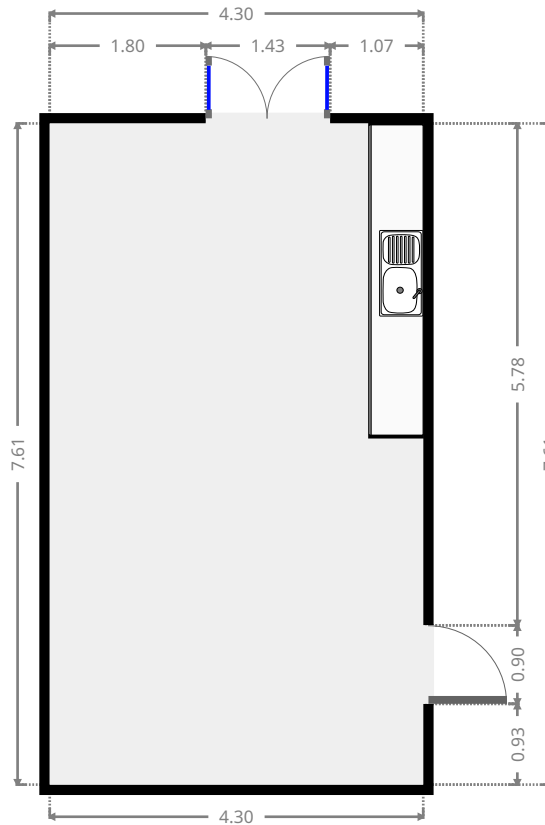
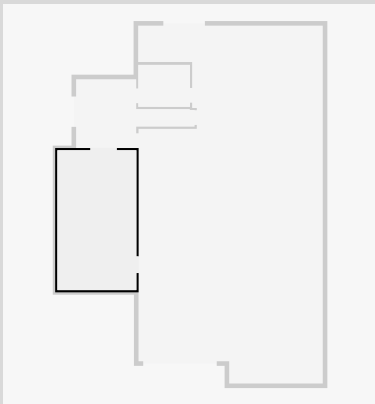

THIS FLOORPLAN IS PROVIDED WITHOUT WARRANTY OF ANY KIND. SENSOPIA DISCLAIMS ANY WARRANTY INCLUDING, WITHOUT LIMITATION, SATISFACTORY QUALITY OR ACCURACY OF DIMENSIONS.

# 8 Rainbow Court

## Garage/Workshop Area

Width: 10.04 m  
 Length: 19.47 m  
 Area: 178.27 m<sup>2</sup>  
 Perimeter: 65.35 m

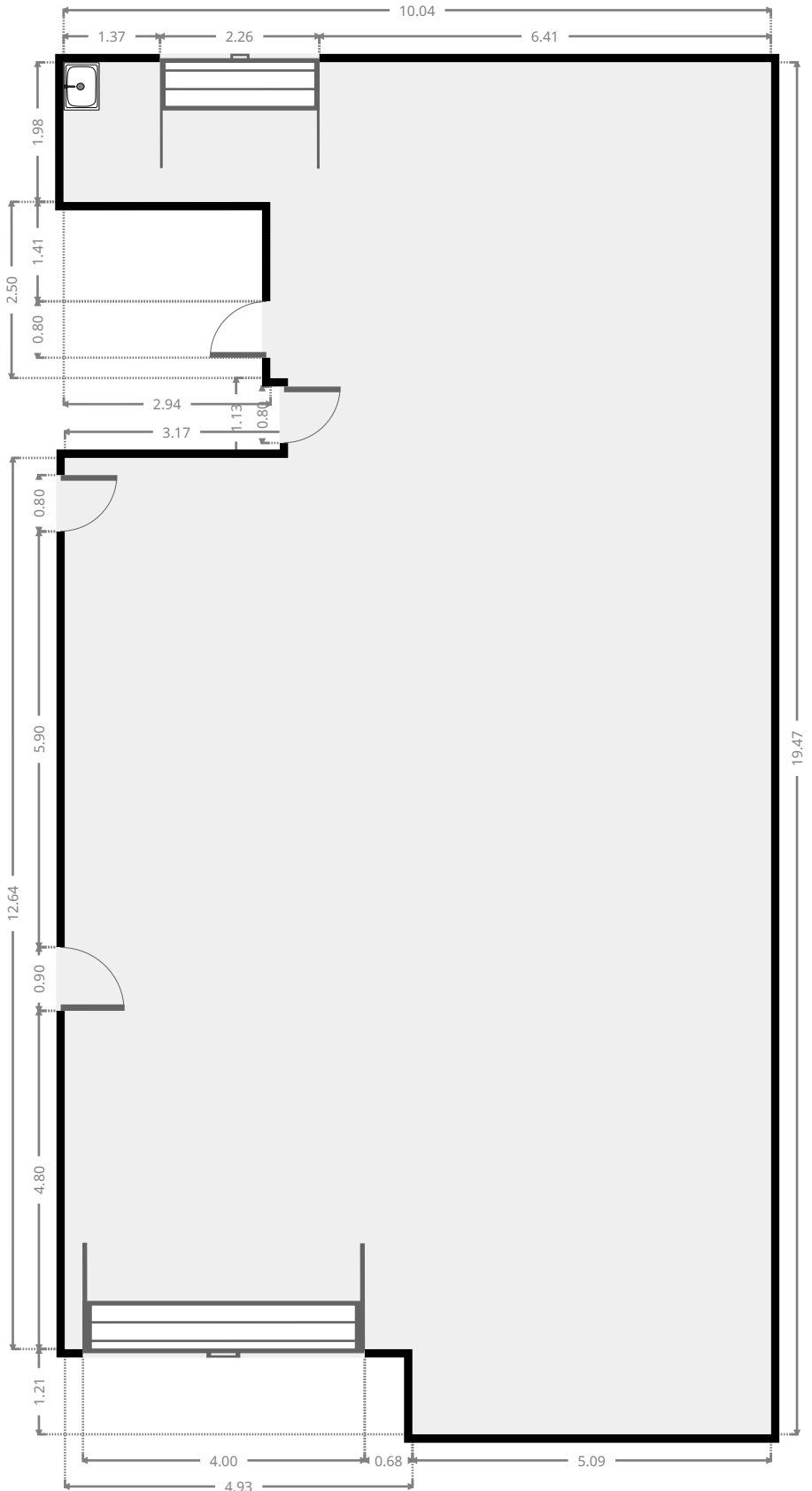
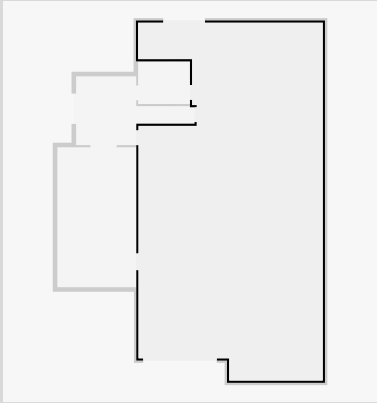

THIS FLOORPLAN IS PROVIDED WITHOUT WARRANTY OF ANY KIND. SENSOPIA DISCLAIMS ANY WARRANTY INCLUDING, WITHOUT LIMITATION, SATISFACTORY QUALITY OR ACCURACY OF DIMENSIONS.

# 8 Rainbow Court

## Bathroom

Width: 2.29 m  
 Length: 2.82 m  
 Area: 6.46 m<sup>2</sup>  
 Perimeter: 10.22 m

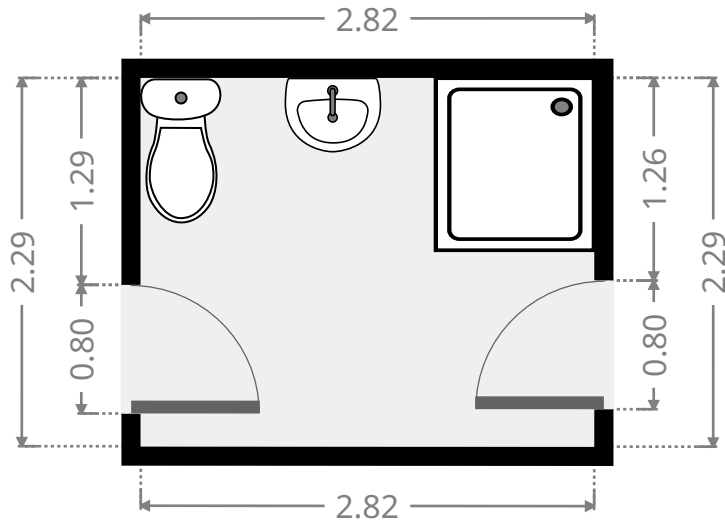
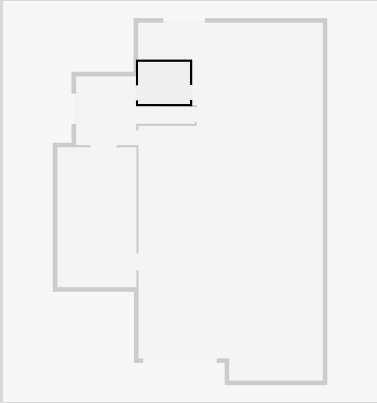

## Stairway

Width: 0.96 m  
 Length: 3.06 m  
 Area: 2.91 m<sup>2</sup>  
 Perimeter: 8.03 m

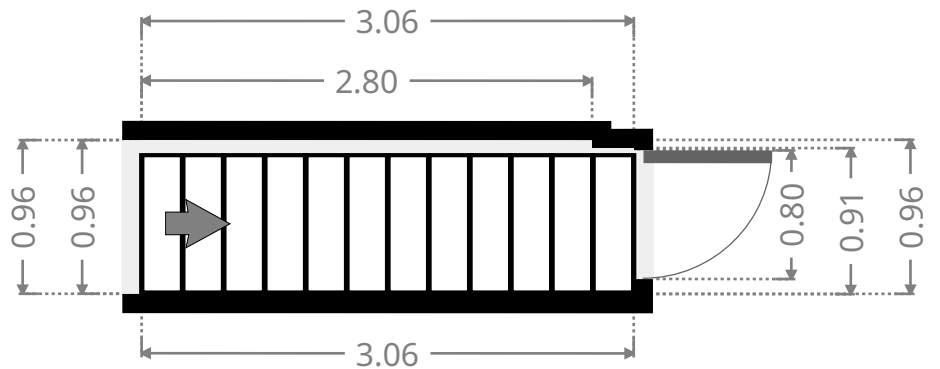
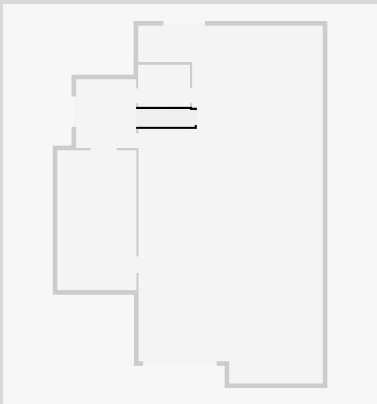

THIS FLOORPLAN IS PROVIDED WITHOUT WARRANTY OF ANY KIND. SENSOPIA DISCLAIMS ANY WARRANTY INCLUDING, WITHOUT LIMITATION, SATISFACTORY QUALITY OR ACCURACY OF DIMENSIONS.

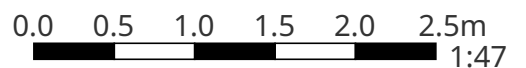

# 8 Rainbow Court

## 1st Floor

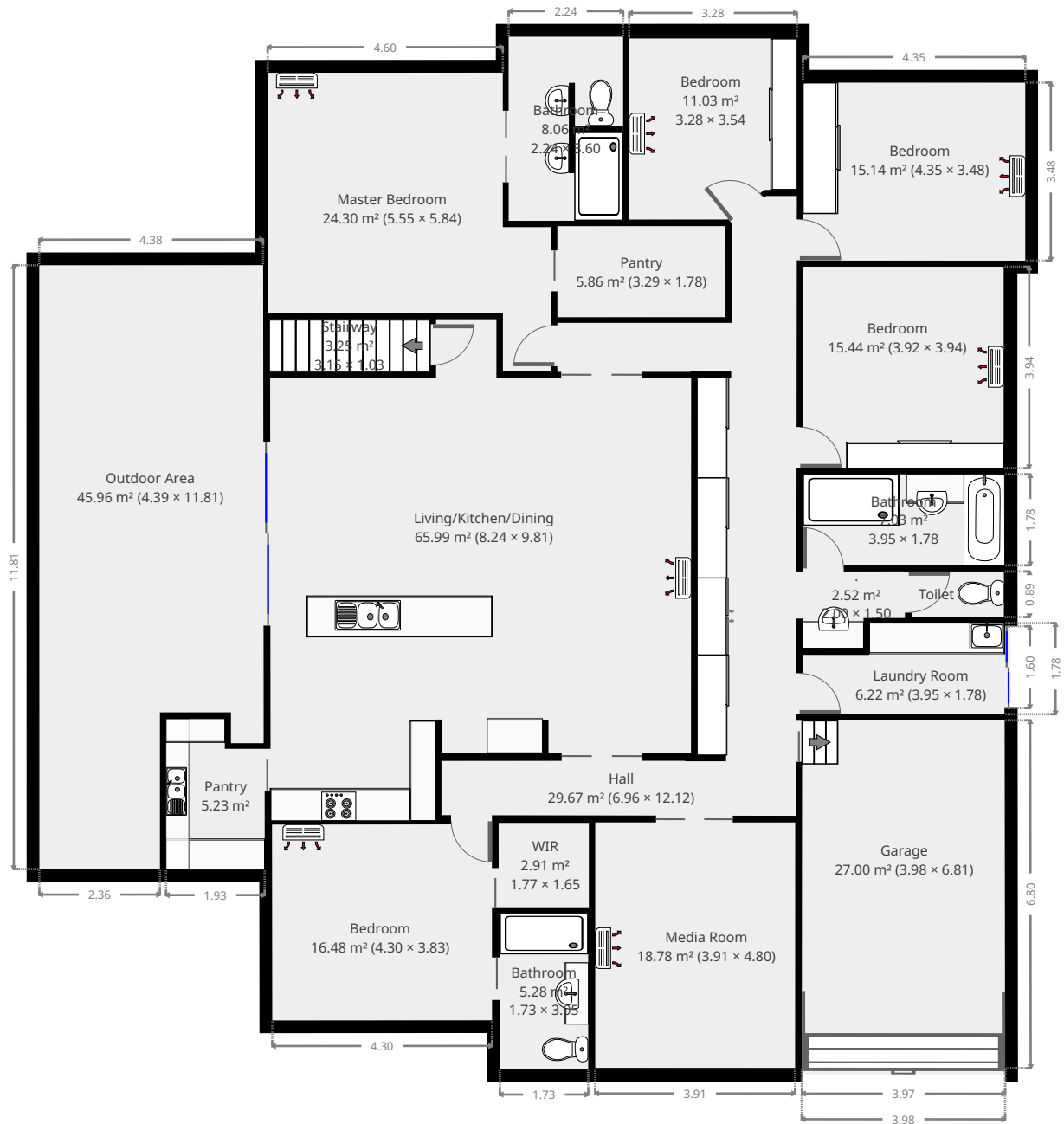

THIS FLOORPLAN IS PROVIDED WITHOUT WARRANTY OF ANY KIND. SENSOPIA DISCLAIMS ANY WARRANTY INCLUDING, WITHOUT LIMITATION, SATISFACTORY QUALITY OR ACCURACY OF DIMENSIONS.

0 2 4 6m  
1:128

# 8 Rainbow Court

## Garage

Width: 3.98 m  
 Length: 6.81 m  
 Area: 27.00 m<sup>2</sup>  
 Perimeter: 21.54 m

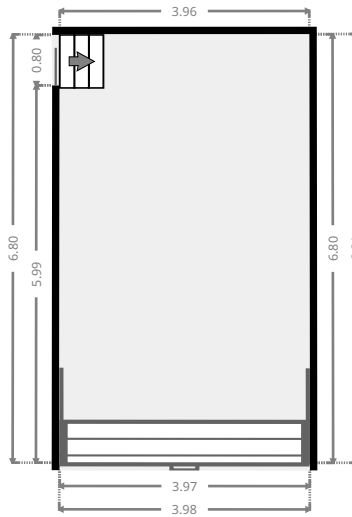
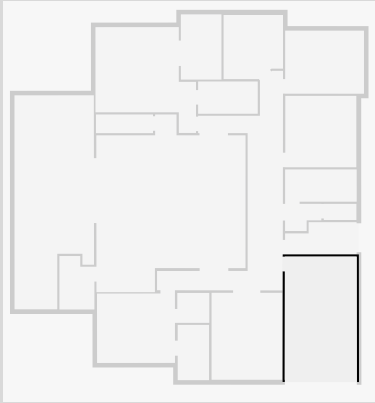

## Outdoor Area

Width: 4.39 m  
 Length: 11.81 m  
 Area: 45.96 m<sup>2</sup>  
 Perimeter: 33.59 m

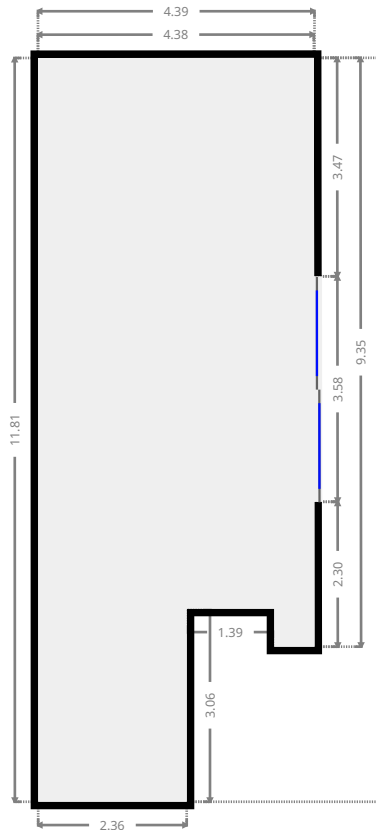
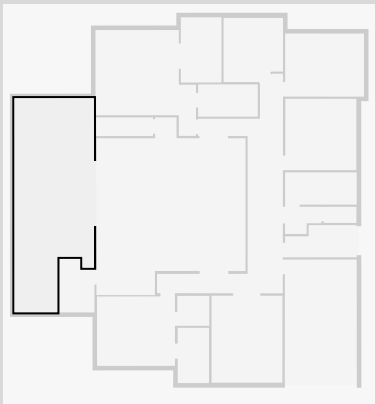

THIS FLOORPLAN IS PROVIDED WITHOUT WARRANTY OF ANY KIND. SENSOPIA DISCLAIMS ANY WARRANTY INCLUDING, WITHOUT LIMITATION, SATISFACTORY QUALITY OR ACCURACY OF DIMENSIONS.

# 8 Rainbow Court

## Stairway

Width: 1.03 m  
Length: 3.15 m  
Area: 3.25 m<sup>2</sup>  
Perimeter: 8.36 m

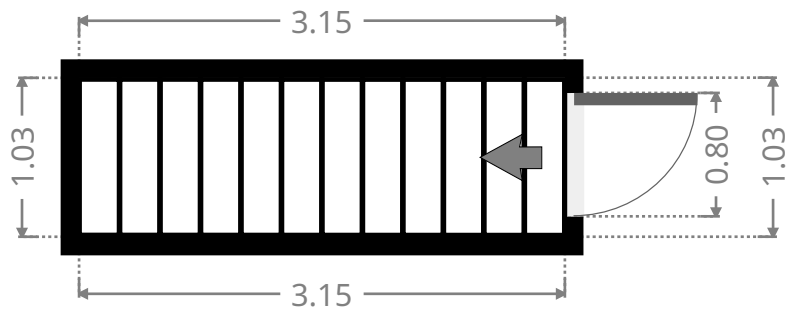
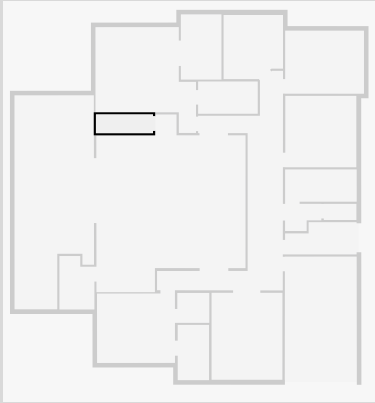

## Bedroom

Width: 3.28 m  
Length: 3.54 m  
Area: 11.03 m<sup>2</sup>  
Perimeter: 13.27 m

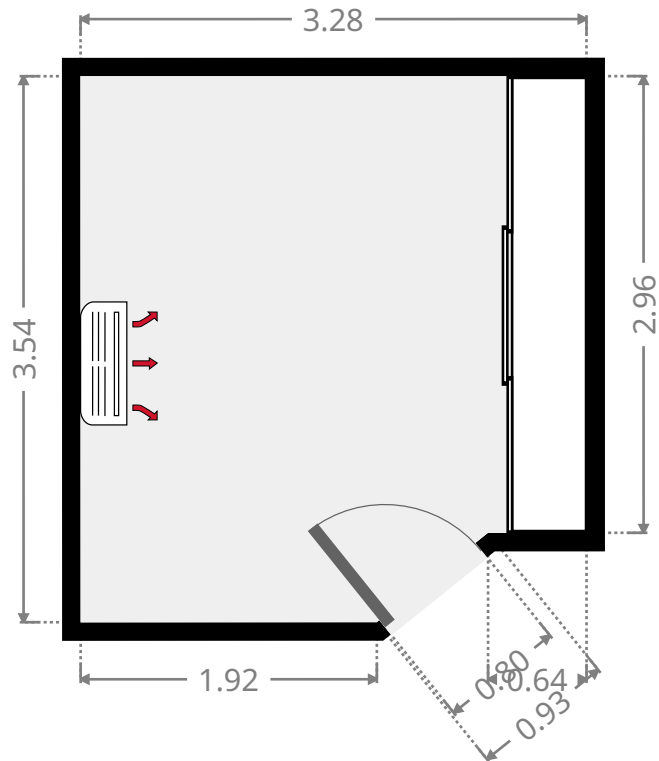
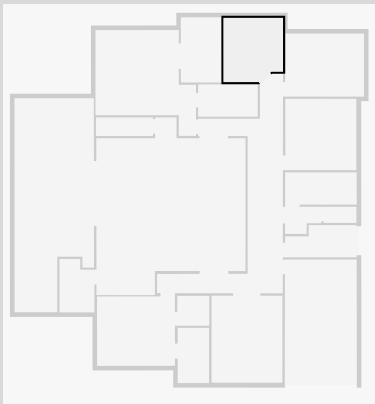

# 8 Rainbow Court

## Bedroom

Width: 3.48 m  
 Length: 4.35 m  
 Area: 15.14 m<sup>2</sup>  
 Perimeter: 15.66 m

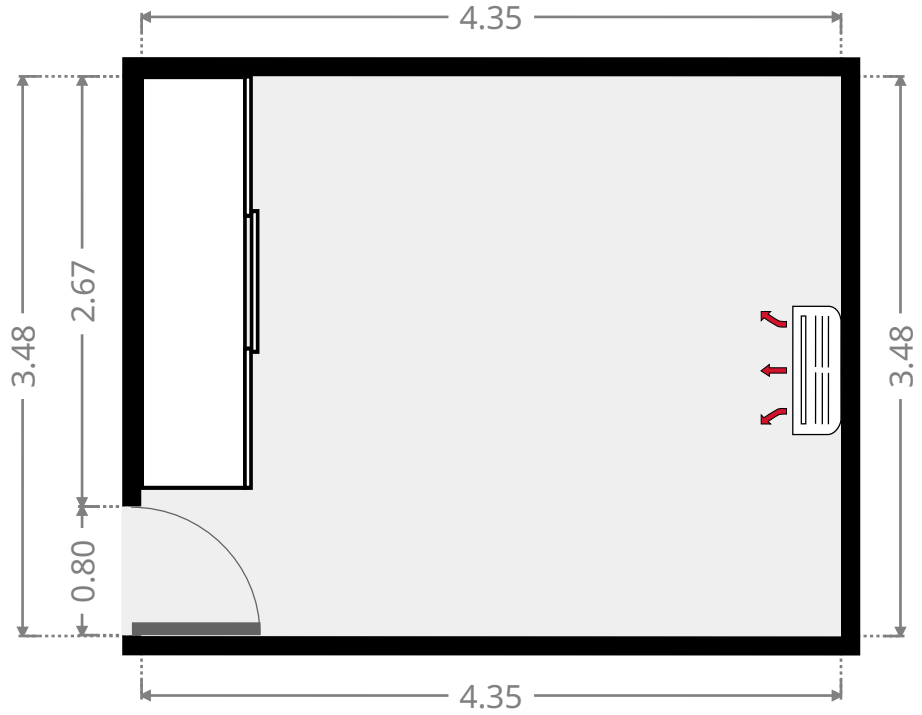
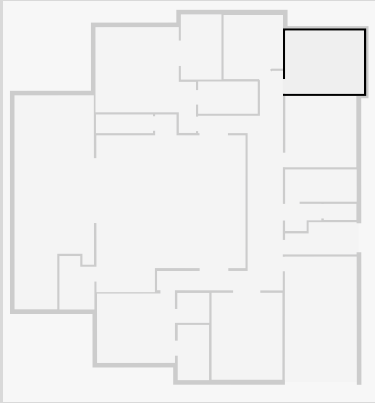

## Bedroom

Width: 3.92 m  
 Length: 3.94 m  
 Area: 15.44 m<sup>2</sup>  
 Perimeter: 15.72 m

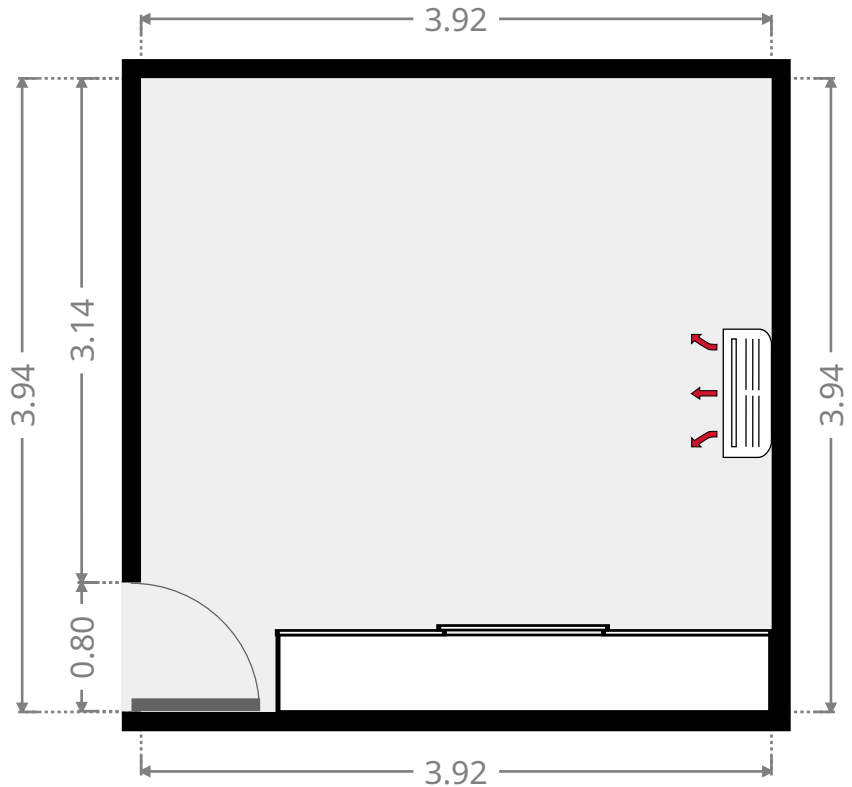
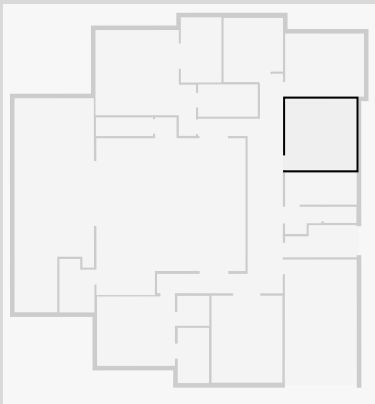

THIS FLOORPLAN IS PROVIDED WITHOUT WARRANTY OF ANY KIND. SENSOPIA DISCLAIMS ANY WARRANTY INCLUDING, WITHOUT LIMITATION, SATISFACTORY QUALITY OR ACCURACY OF DIMENSIONS.

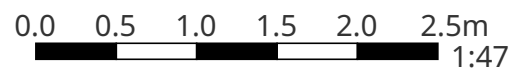



# 8 Rainbow Court

## Bathroom

Width: 1.78 m  
Length: 3.95 m  
Area: 7.03 m<sup>2</sup>  
Perimeter: 11.46 m

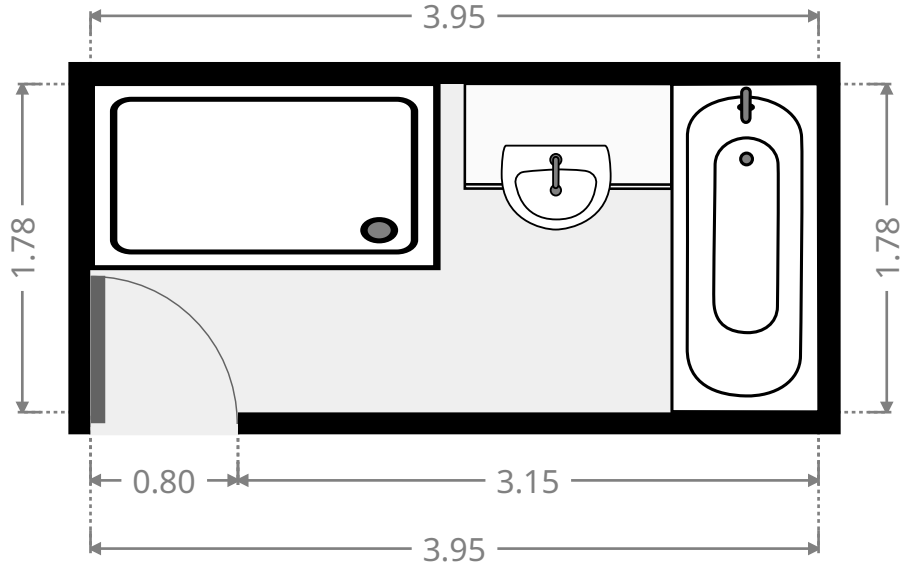
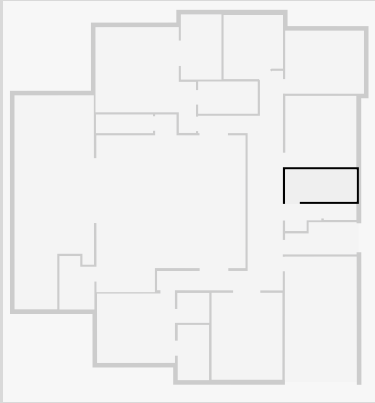

## Toilet / Half Bath

Width: 0.89 m  
Length: 1.80 m  
Area: 1.60 m<sup>2</sup>  
Perimeter: 5.38 m

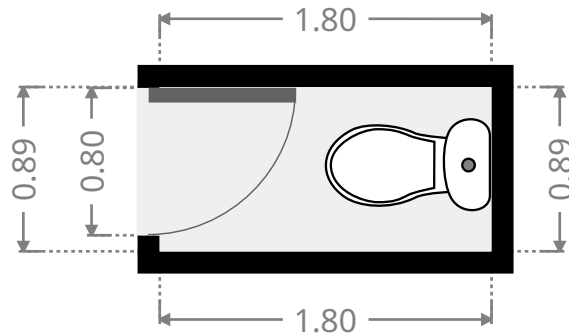
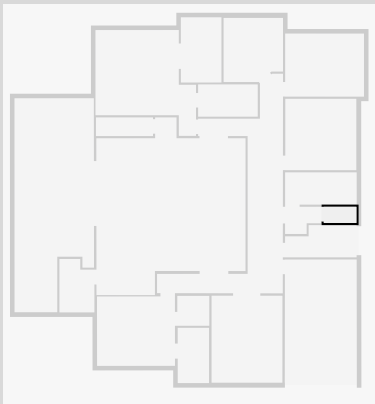

# 8 Rainbow Court

Width: 1.50 m  
 Length: 2.00 m  
 Area: 2.52 m<sup>2</sup>  
 Perimeter: 7.00 m

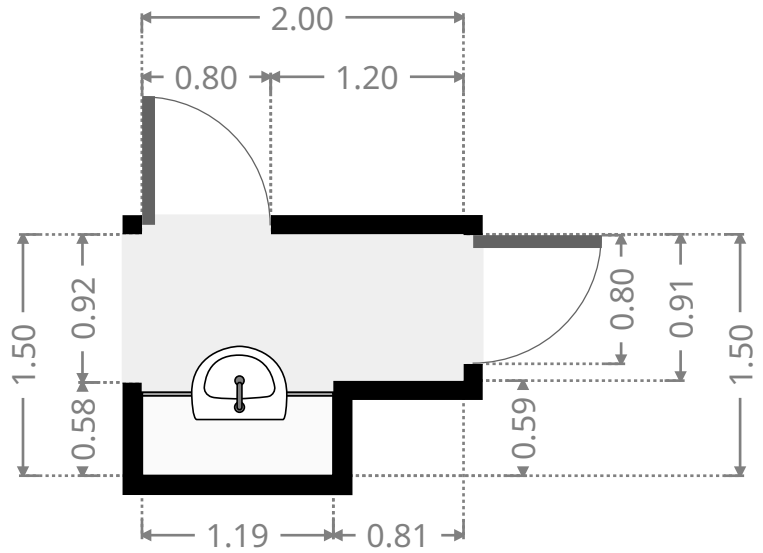
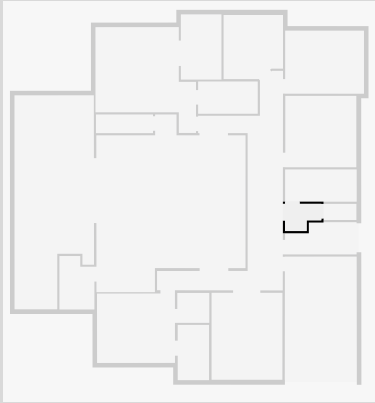

## Laundry Room

Width: 1.78 m  
 Length: 3.95 m  
 Area: 6.22 m<sup>2</sup>  
 Perimeter: 11.45 m

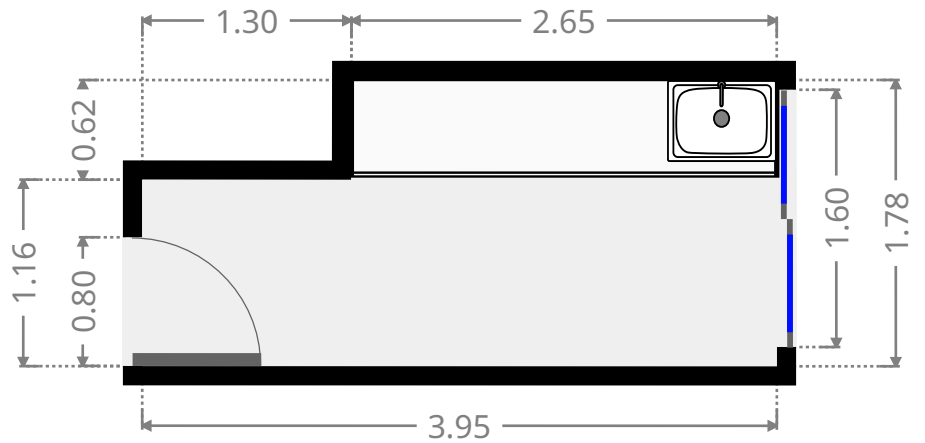
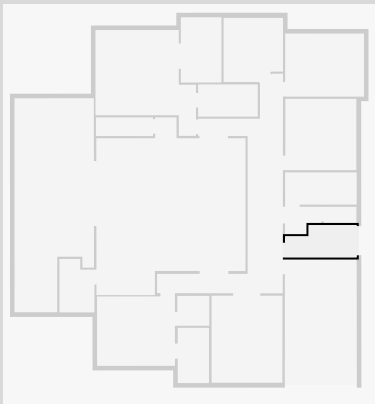

# 8 Rainbow Court

## Living/Kitchen/Dining

Width: 8.24 m  
 Length: 9.81 m  
 Area: 65.99 m<sup>2</sup>  
 Perimeter: 36.08 m

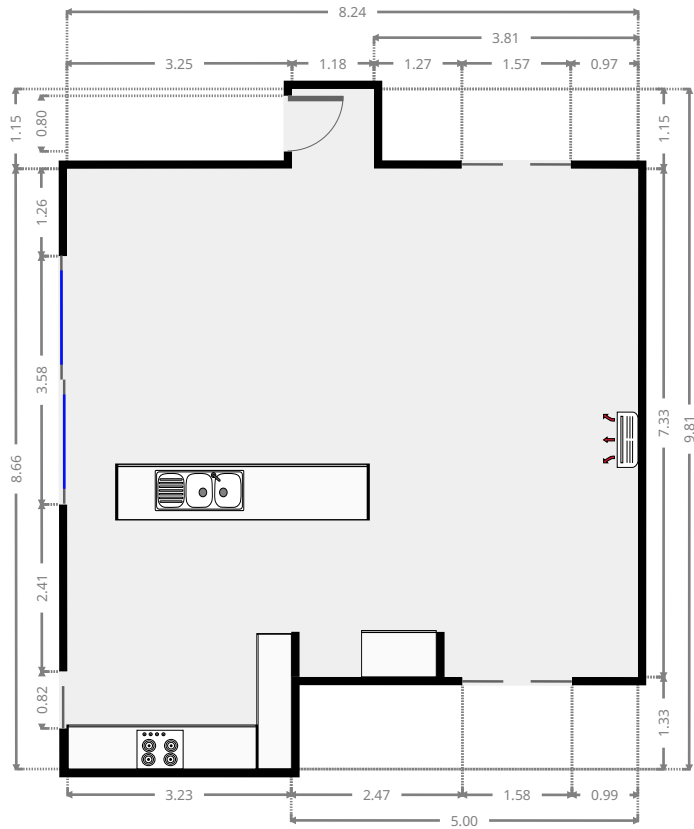
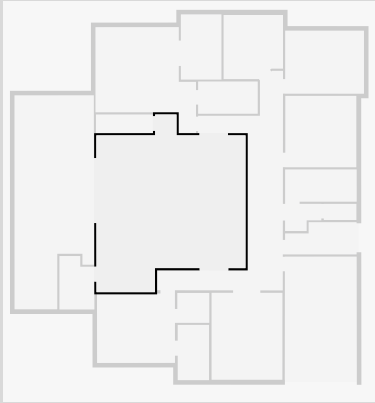

## Media Room

Width: 3.91 m  
 Length: 4.80 m  
 Area: 18.78 m<sup>2</sup>  
 Perimeter: 17.42 m

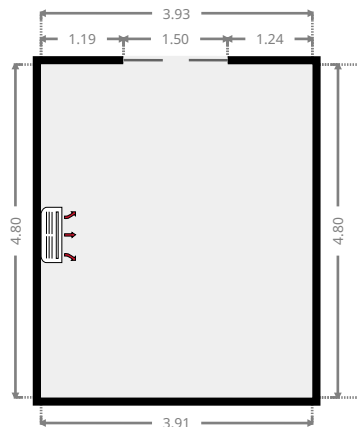
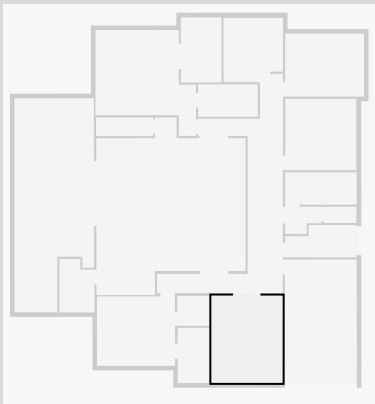

# 8 Rainbow Court

## WIR

Width: 1.65 m  
Length: 1.77 m  
Area: 2.91 m<sup>2</sup>  
Perimeter: 6.83 m

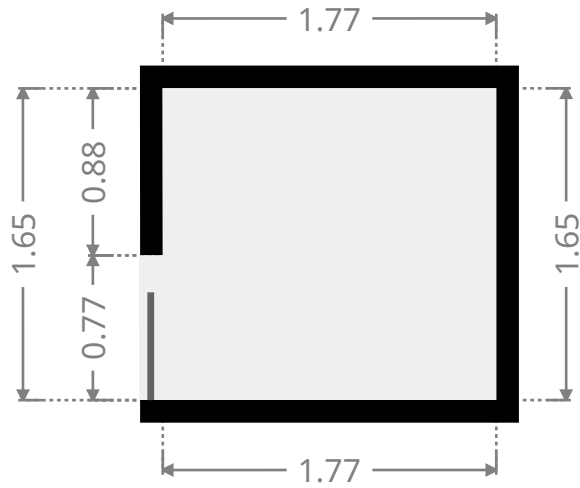
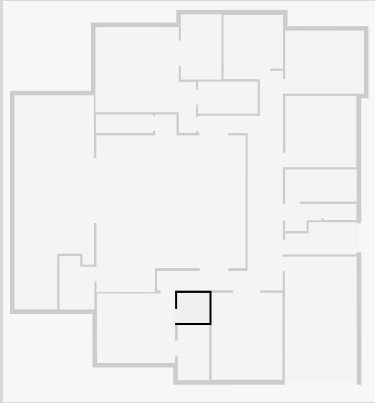

## Bathroom

Width: 1.73 m  
Length: 3.05 m  
Area: 5.28 m<sup>2</sup>  
Perimeter: 9.56 m

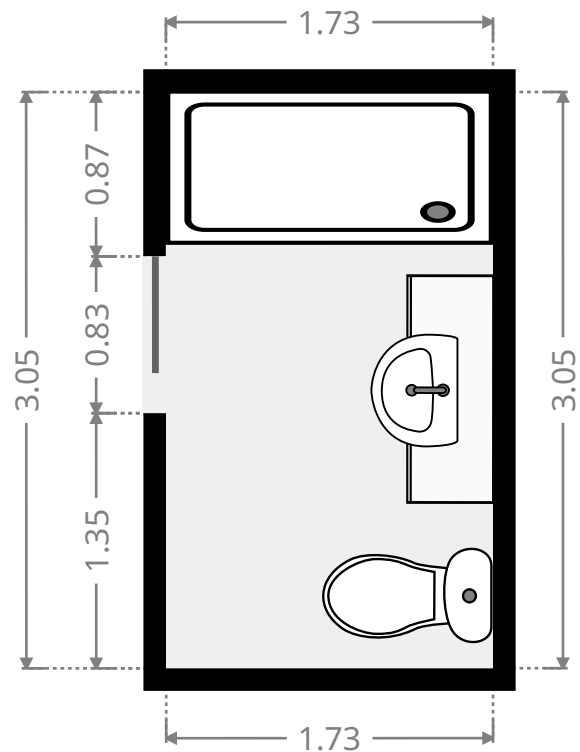
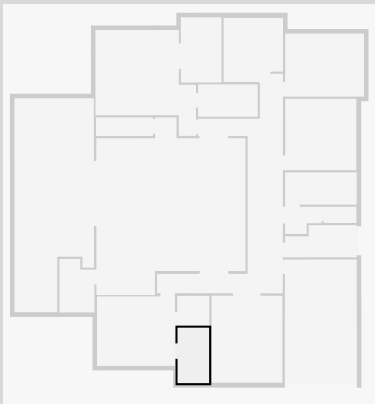

THIS FLOORPLAN IS PROVIDED WITHOUT WARRANTY OF ANY KIND. SENSOPIA DISCLAIMS ANY WARRANTY INCLUDING, WITHOUT LIMITATION, SATISFACTORY QUALITY OR ACCURACY OF DIMENSIONS.

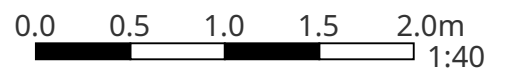

# 8 Rainbow Court

## Bedroom

Width: 3.83 m  
 Length: 4.30 m  
 Area: 16.48 m<sup>2</sup>  
 Perimeter: 16.27 m

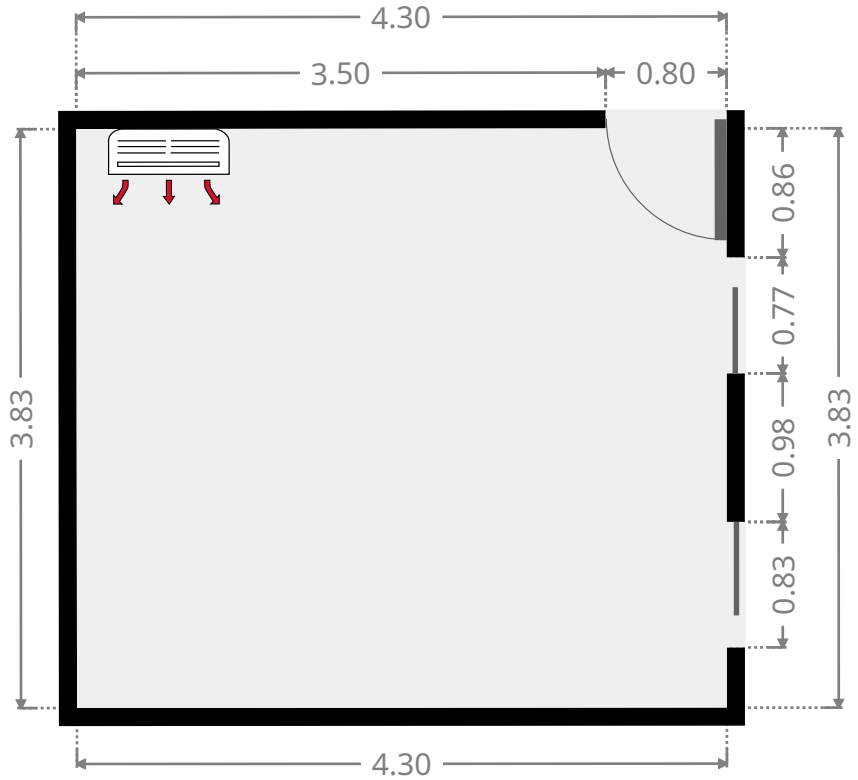
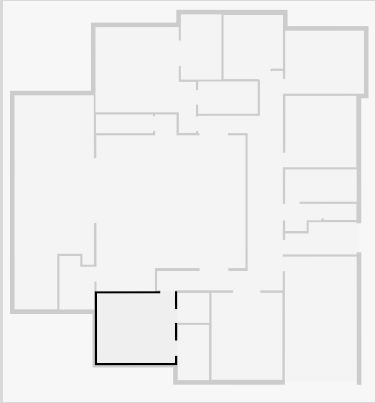

## Pantry

Width: 1.78 m  
 Length: 3.29 m  
 Area: 5.86 m<sup>2</sup>  
 Perimeter: 10.14 m

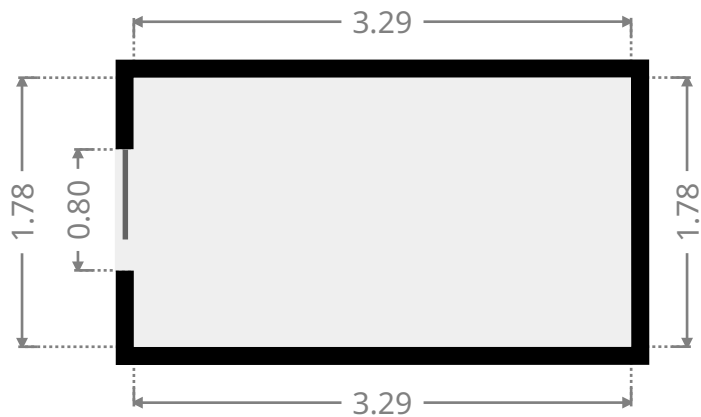
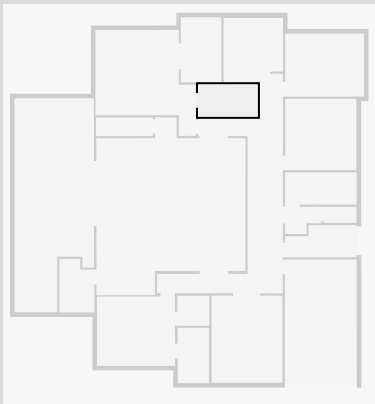

# 8 Rainbow Court

## Bathroom

Width: 2.24 m  
 Length: 3.60 m  
 Area: 8.06 m<sup>2</sup>  
 Perimeter: 11.68 m

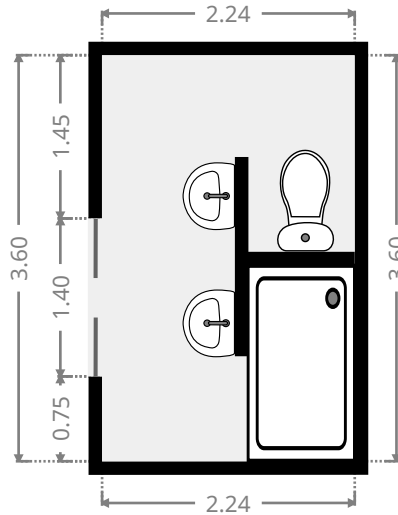
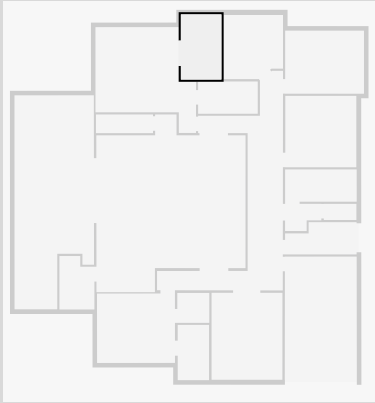

## Master Bedroom

Width: 5.55 m  
 Length: 5.84 m  
 Area: 24.30 m<sup>2</sup>  
 Perimeter: 22.78 m

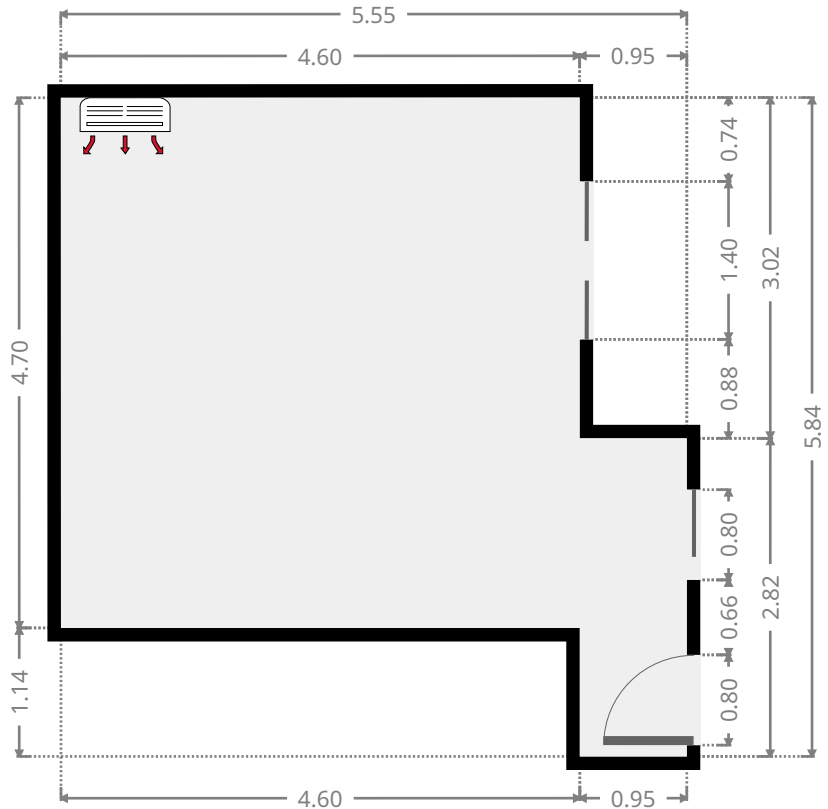
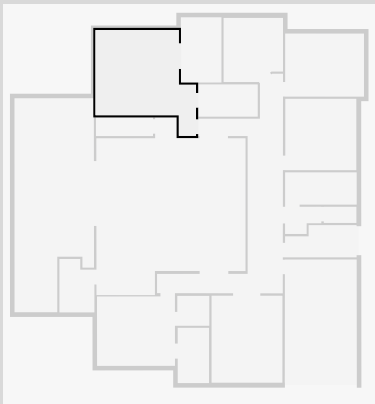

THIS FLOORPLAN IS PROVIDED WITHOUT WARRANTY OF ANY KIND. SENSOPIA DISCLAIMS ANY WARRANTY INCLUDING, WITHOUT LIMITATION, SATISFACTORY QUALITY OR ACCURACY OF DIMENSIONS.

# 8 Rainbow Court

## Hall

Width: 6.96 m  
 Length: 12.12 m  
 Area: 29.67 m<sup>2</sup>  
 Perimeter: 43.23 m

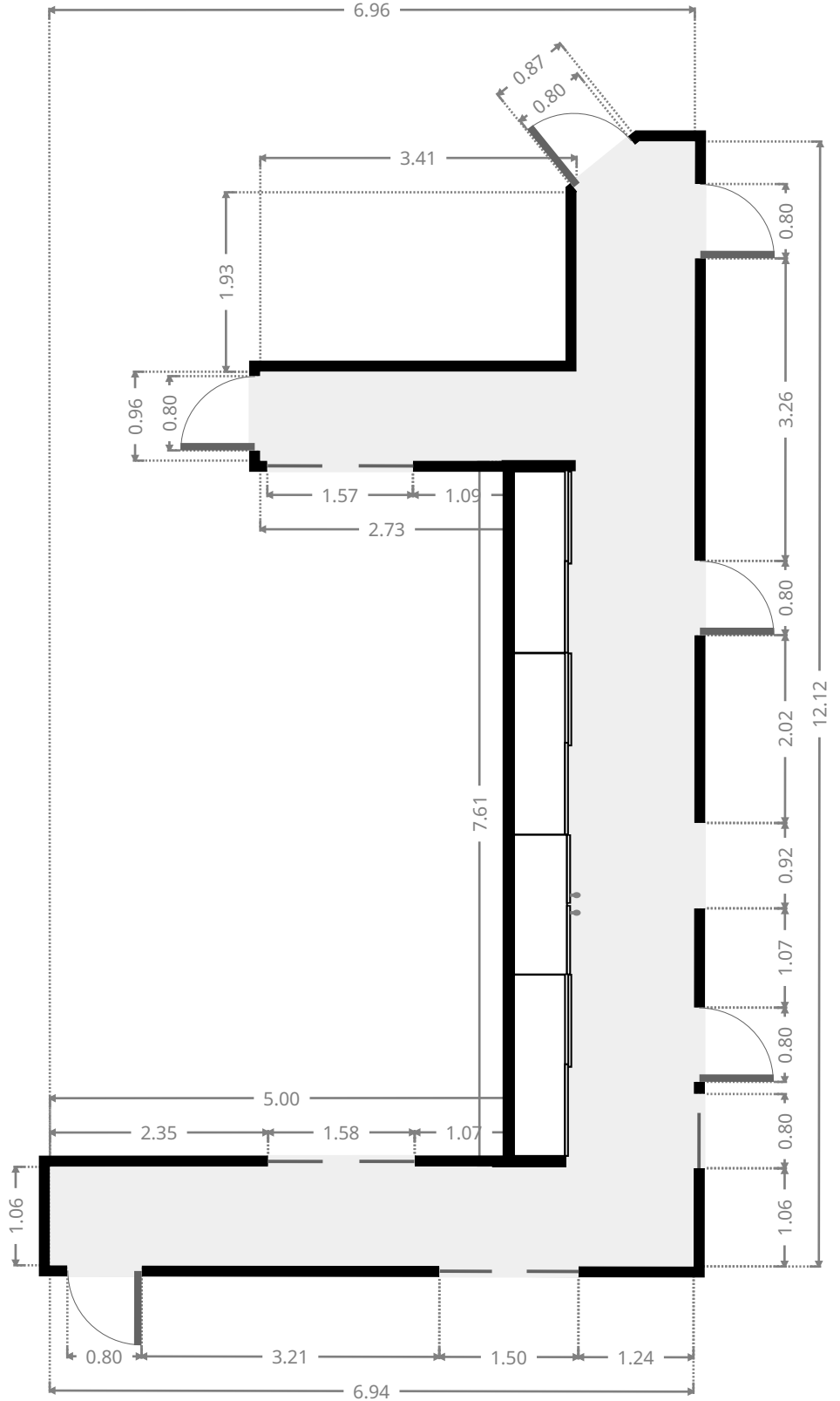
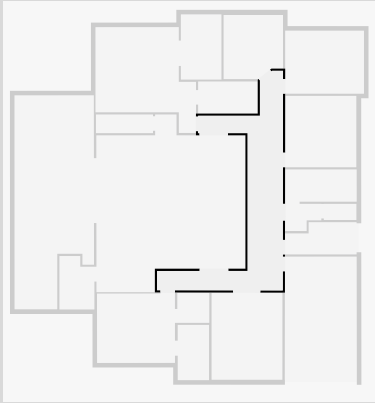

THIS FLOORPLAN IS PROVIDED WITHOUT WARRANTY OF ANY KIND. SENSOPIA DISCLAIMS ANY WARRANTY INCLUDING, WITHOUT LIMITATION, SATISFACTORY QUALITY OR ACCURACY OF DIMENSIONS.

# 8 Rainbow Court

## Pantry

Width: 1.93 m  
Length: 2.95 m  
Area: 5.23 m<sup>2</sup>  
Perimeter: 9.76 m

