

8 Goodson Street

Ground Floor

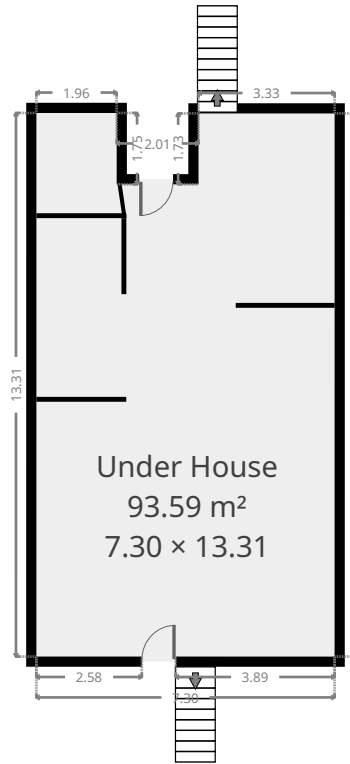

THIS FLOORPLAN IS PROVIDED WITHOUT WARRANTY OF ANY KIND. SENSOPIA DISCLAIMS ANY WARRANTY INCLUDING, WITHOUT LIMITATION, SATISFACTORY QUALITY OR ACCURACY OF DIMENSIONS.



8 Goodson Street

Under House

Width: 7.30 m
Length: 13.31 m
Area: 93.59 m²
Perimeter: 44.68 m

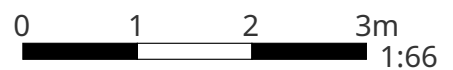
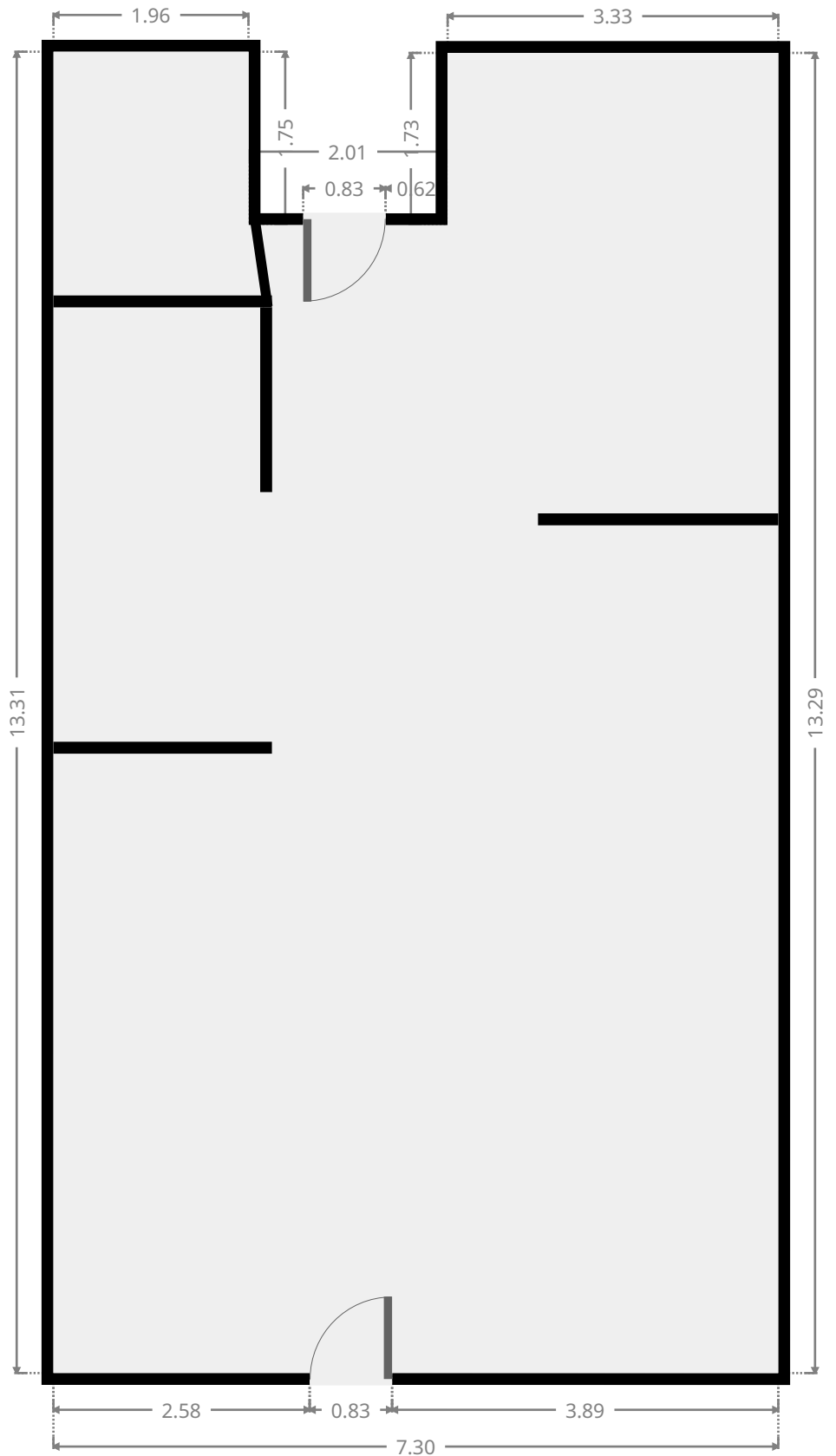
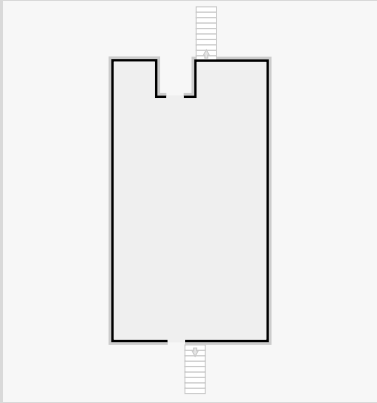

THIS FLOORPLAN IS PROVIDED WITHOUT WARRANTY OF ANY KIND. SENSOPIA DISCLAIMS ANY WARRANTY INCLUDING, WITHOUT LIMITATION, SATISFACTORY QUALITY OR ACCURACY OF DIMENSIONS.

8 Goodson Street

1st Floor

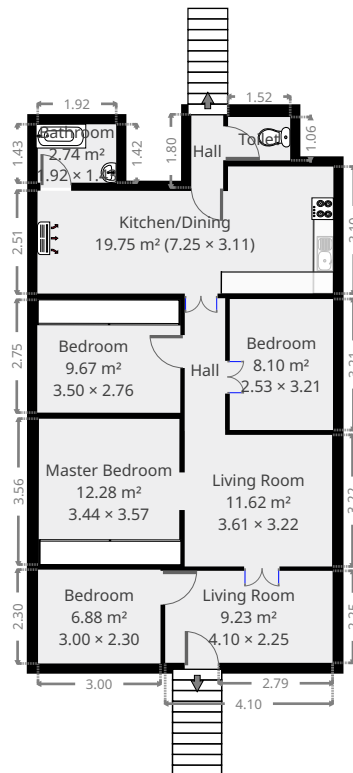
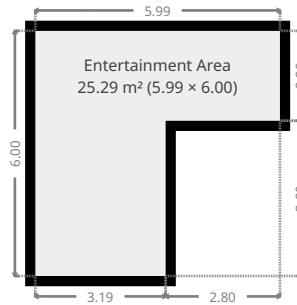
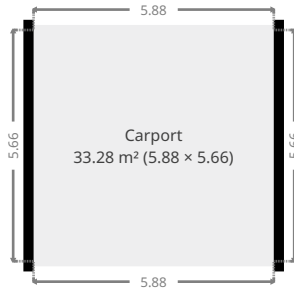

THIS FLOORPLAN IS PROVIDED WITHOUT WARRANTY OF ANY KIND. SENSOPIA DISCLAIMS ANY WARRANTY INCLUDING, WITHOUT LIMITATION, SATISFACTORY QUALITY OR ACCURACY OF DIMENSIONS.



8 Goodson Street

Kitchen/Dining

Width: 3.11 m
 Length: 7.25 m
 Area: 19.75 m²
 Perimeter: 20.72 m

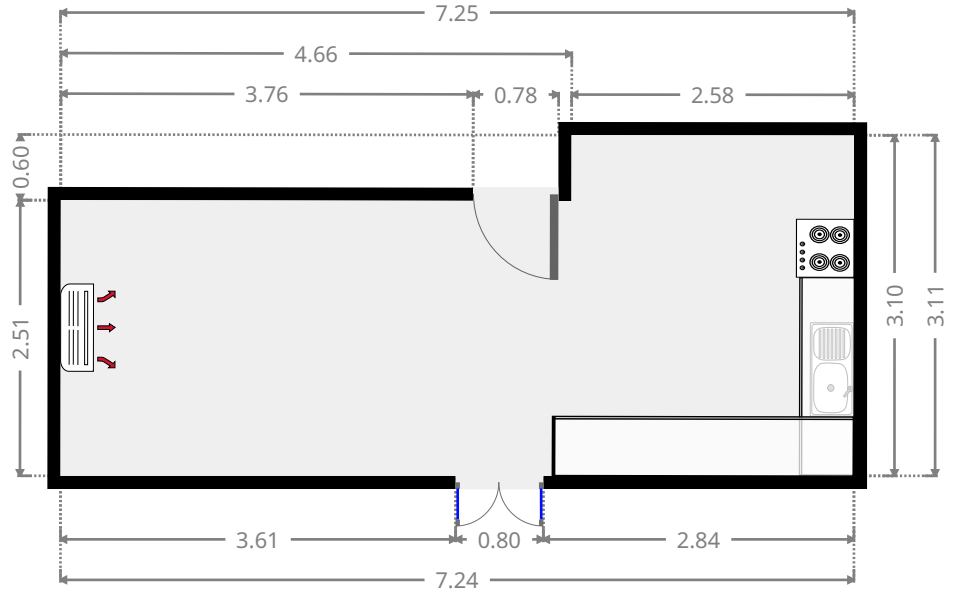
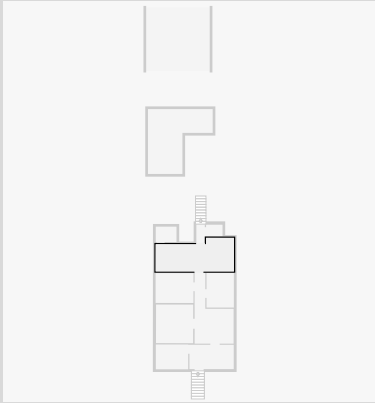

Hall

Width: 0.99 m
 Length: 3.25 m
 Area: 3.21 m²
 Perimeter: 8.48 m

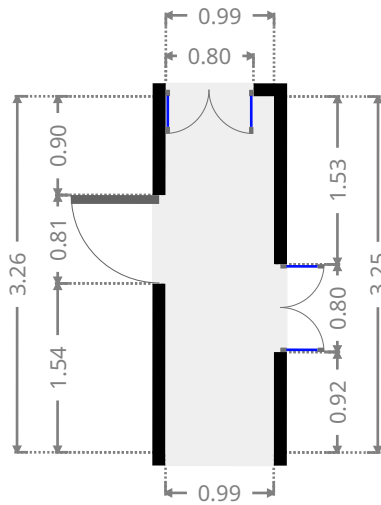
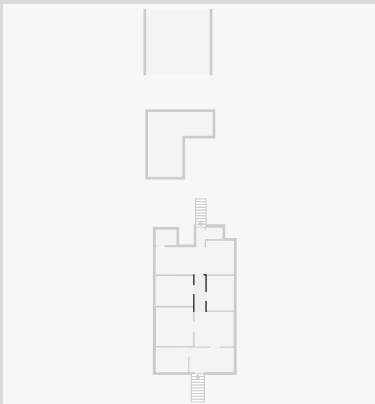

THIS FLOORPLAN IS PROVIDED WITHOUT WARRANTY OF ANY KIND. SENSOPIA DISCLAIMS ANY WARRANTY INCLUDING, WITHOUT LIMITATION, SATISFACTORY QUALITY OR ACCURACY OF DIMENSIONS.

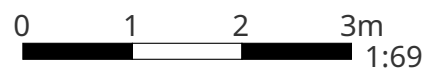

8 Goodson Street

Hall

Width: 0.78 m
Length: 1.79 m
Area: 1.40 m²
Perimeter: 5.14 m

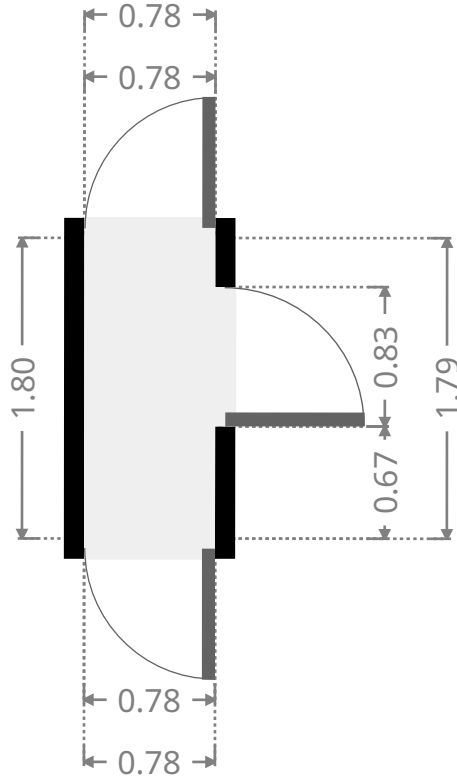
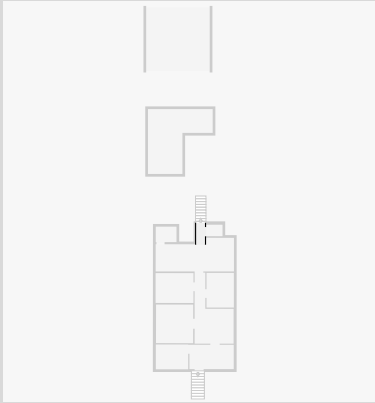

Toilet / Half Bath

Width: 1.06 m
Length: 1.52 m
Area: 1.61 m²
Perimeter: 5.16 m

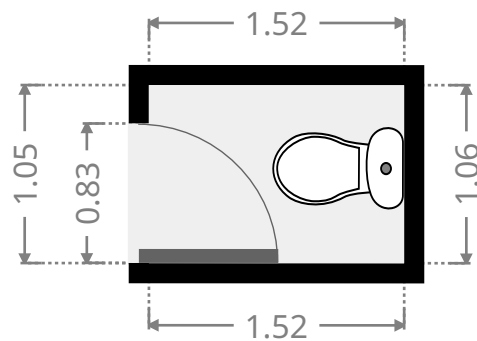
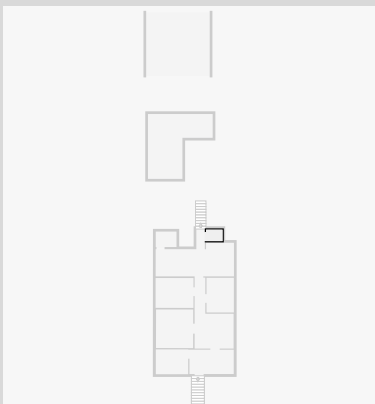

8 Goodson Street

Bedroom

Width: 2.76 m
 Length: 3.50 m
 Area: 9.67 m²
 Perimeter: 12.53 m

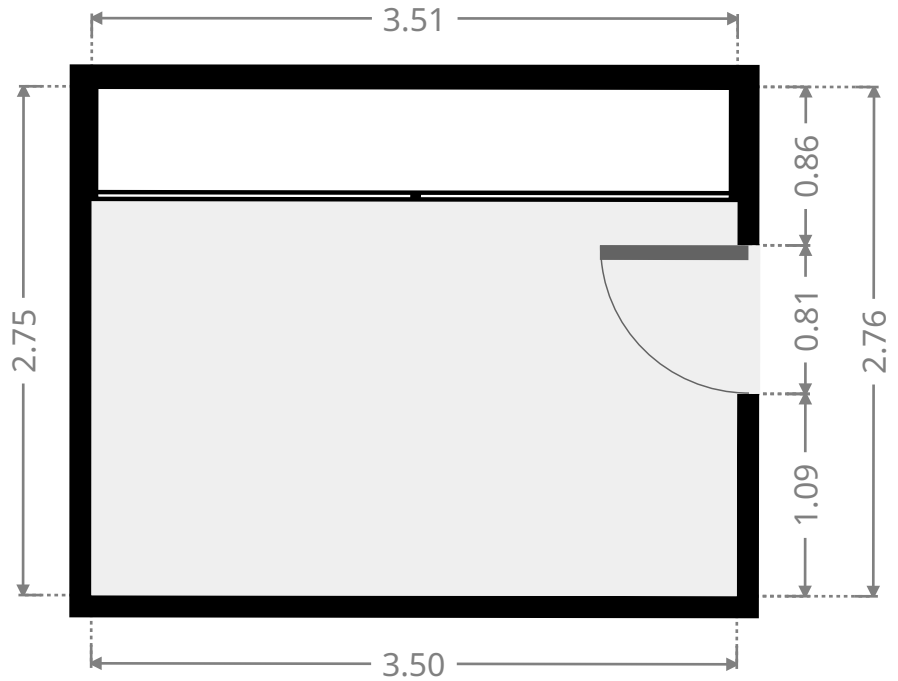
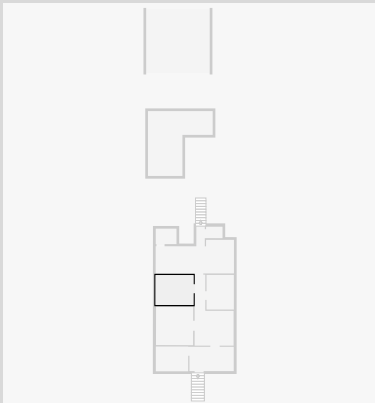

Bedroom

Width: 2.53 m
 Length: 3.21 m
 Area: 8.10 m²
 Perimeter: 11.47 m

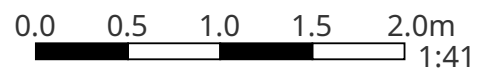
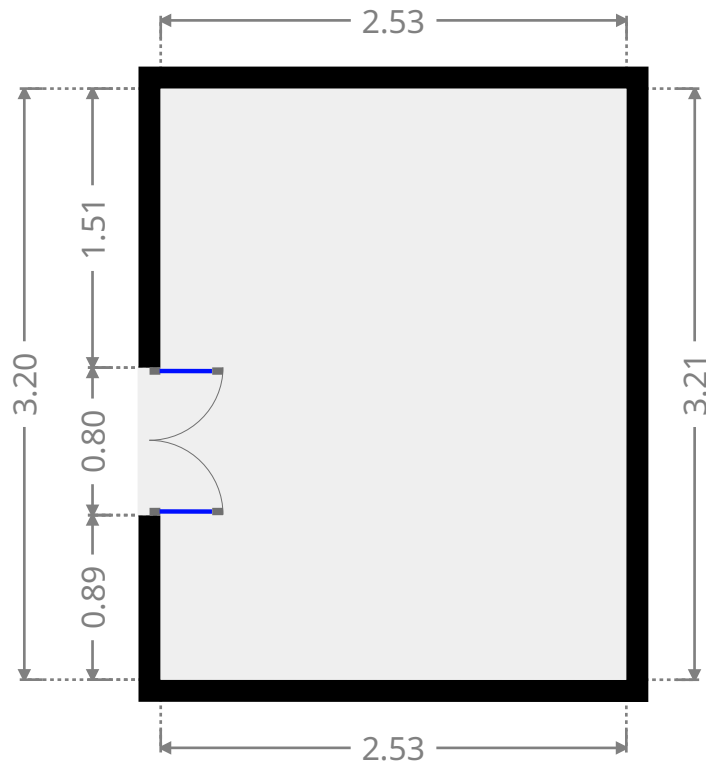
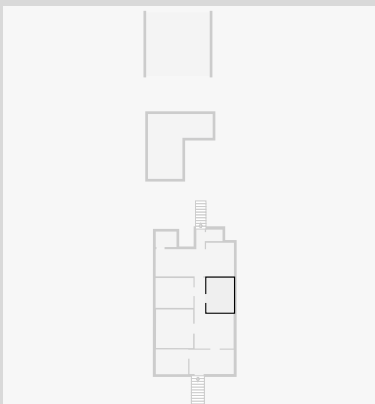

THIS FLOORPLAN IS PROVIDED WITHOUT WARRANTY OF ANY KIND. SENSOPIA DISCLAIMS ANY WARRANTY INCLUDING, WITHOUT LIMITATION, SATISFACTORY QUALITY OR ACCURACY OF DIMENSIONS.

8 Goodson Street

Living Room

Width: 3.22 m
 Length: 3.61 m
 Area: 11.62 m²
 Perimeter: 13.65 m

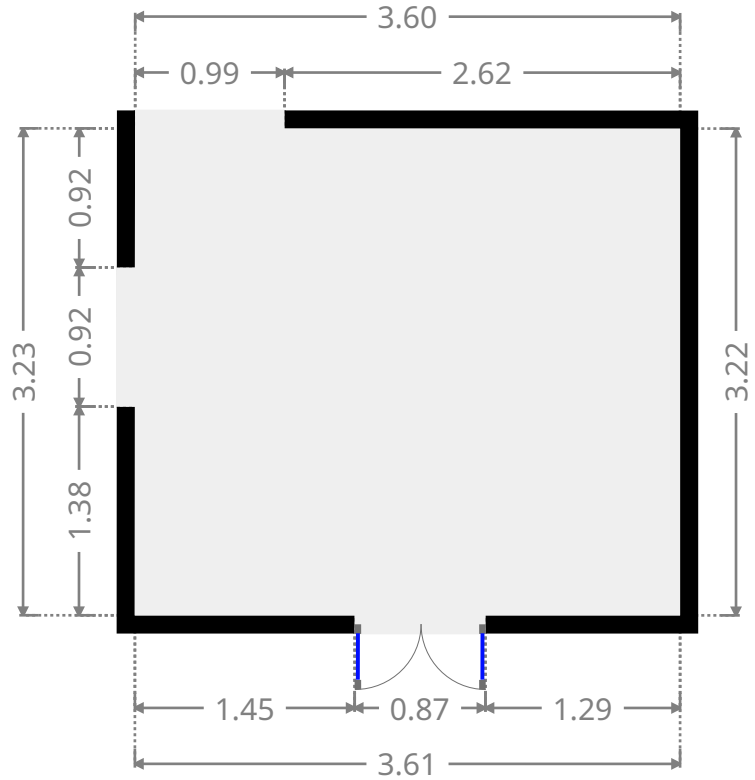
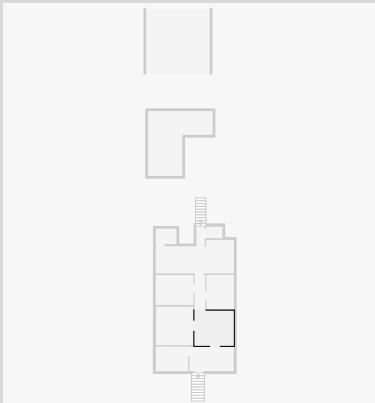

Master Bedroom

Width: 3.44 m
 Length: 3.57 m
 Area: 12.28 m²
 Perimeter: 14.02 m

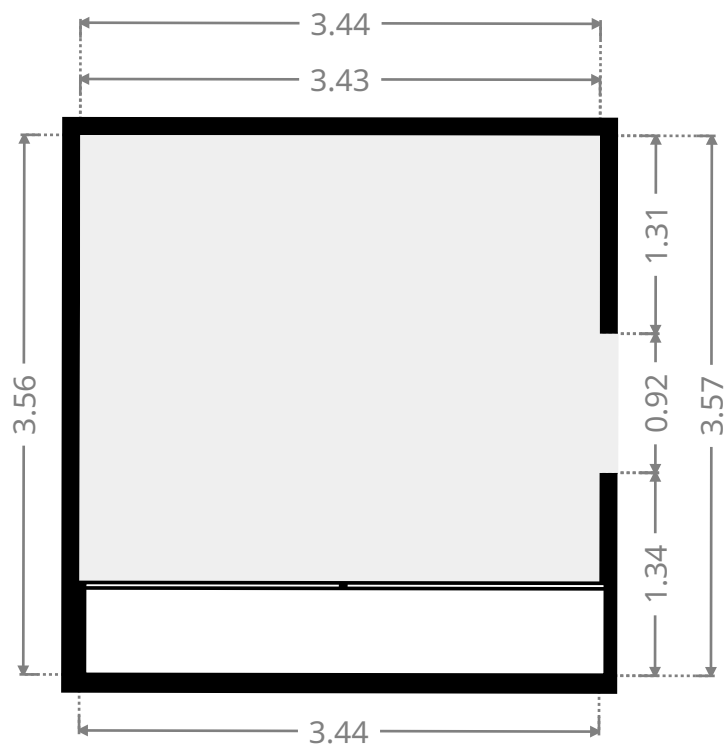
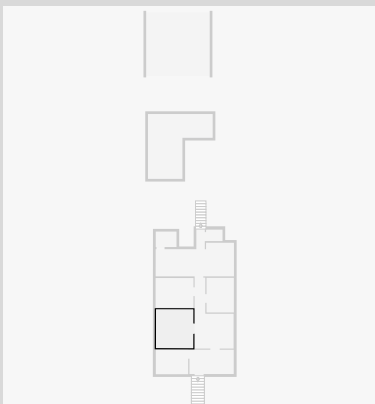

8 Goodson Street

Living Room

Width: 2.25 m
 Length: 4.10 m
 Area: 9.23 m²
 Perimeter: 12.70 m

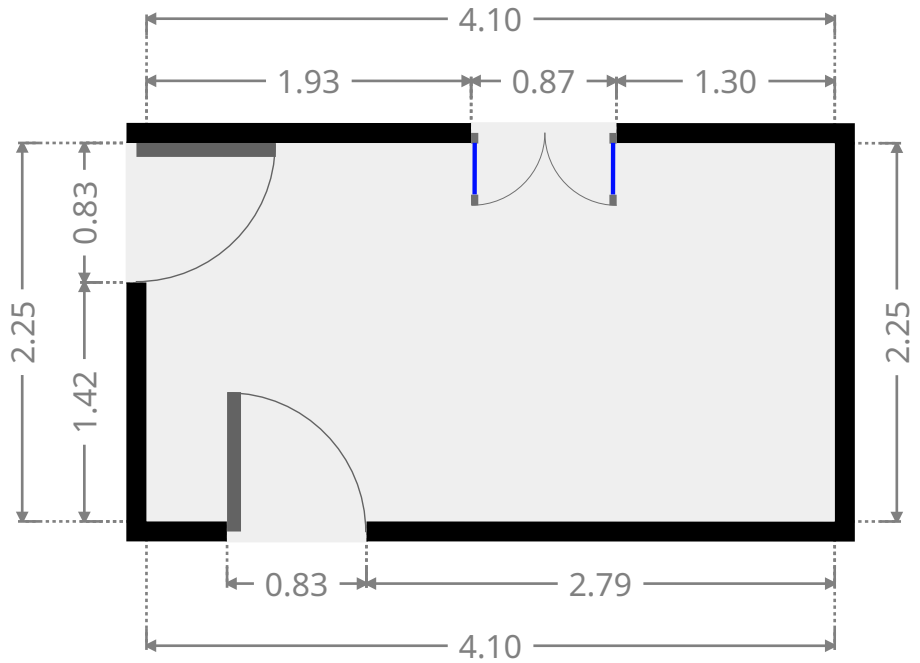
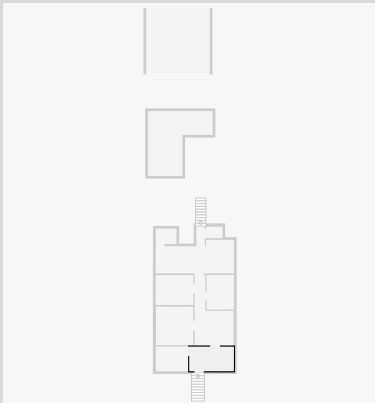

Bedroom

Width: 2.30 m
 Length: 3.00 m
 Area: 6.88 m²
 Perimeter: 10.59 m

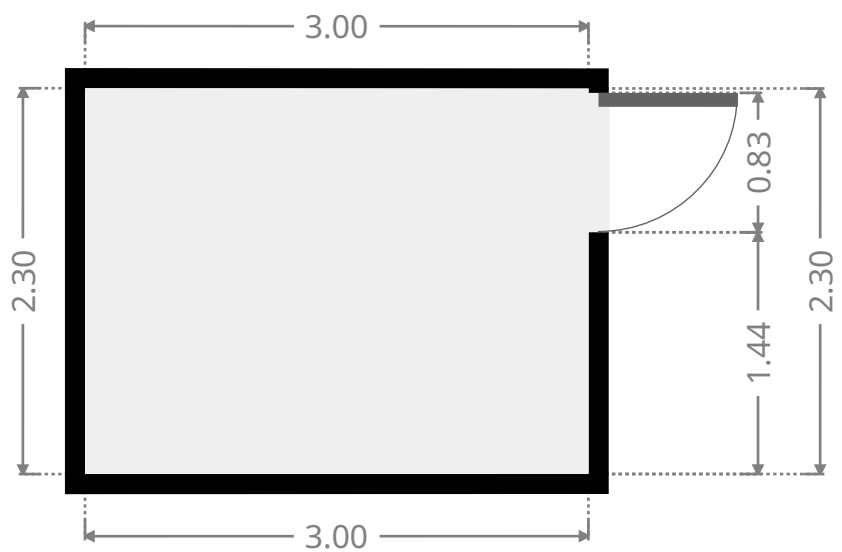
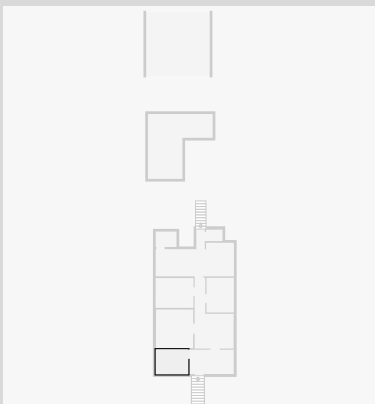

THIS FLOORPLAN IS PROVIDED WITHOUT WARRANTY OF ANY KIND. SENSOPIA DISCLAIMS ANY WARRANTY INCLUDING, WITHOUT LIMITATION, SATISFACTORY QUALITY OR ACCURACY OF DIMENSIONS.

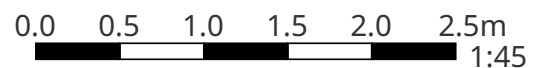

8 Goodson Street

Bathroom

Width: 1.43 m
Length: 1.92 m
Area: 2.74 m²
Perimeter: 6.70 m

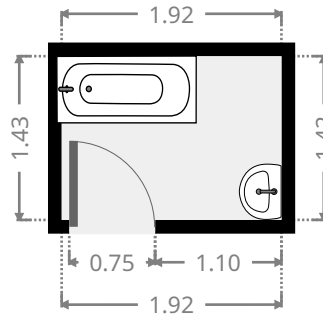
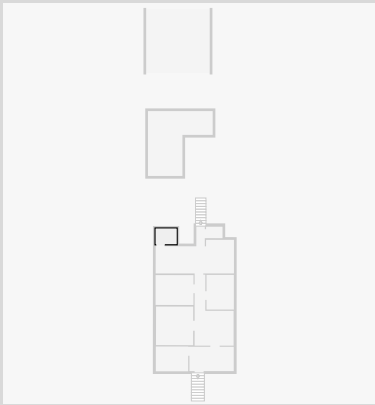

Entertainment Area

Width: 5.99 m
Length: 6.00 m
Area: 25.29 m²
Perimeter: 23.98 m

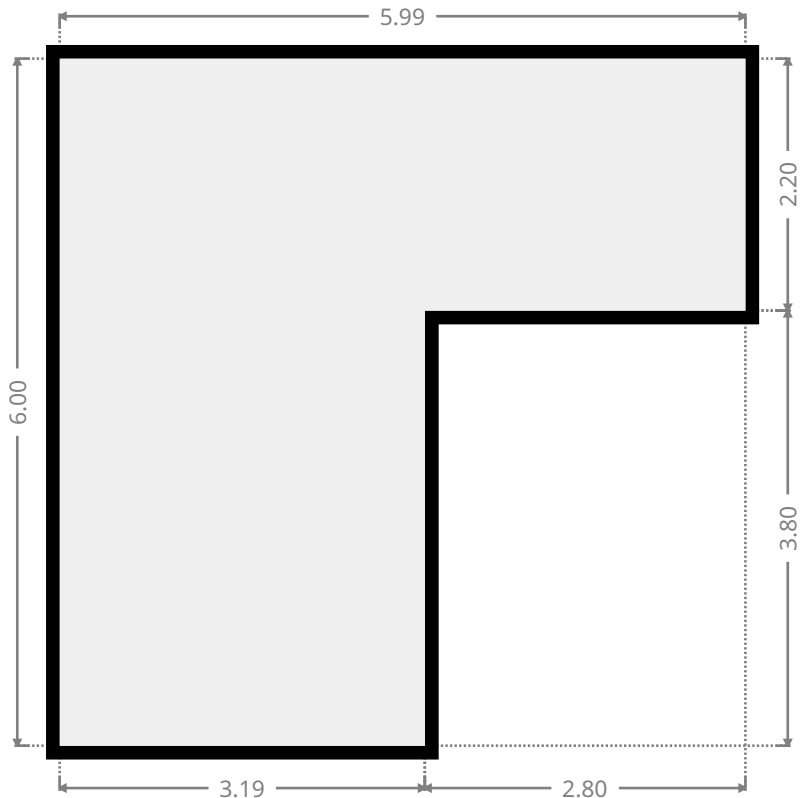
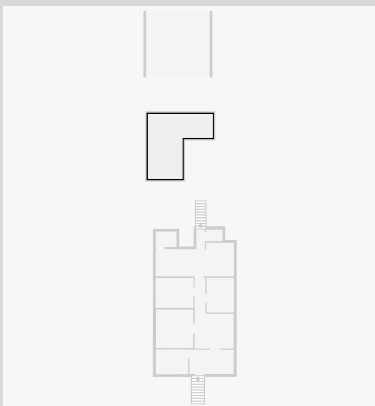

THIS FLOORPLAN IS PROVIDED WITHOUT WARRANTY OF ANY KIND. SENSOPIA DISCLAIMS ANY WARRANTY INCLUDING, WITHOUT LIMITATION, SATISFACTORY QUALITY OR ACCURACY OF DIMENSIONS.



8 Goodson Street

Carport

| | |
|-----------|----------------------|
| Width: | 5.66 m |
| Length: | 5.88 m |
| Area | 33.28 m ² |
| Perimeter | 23.08 m |

