

8 Eyre Court

Ground Floor

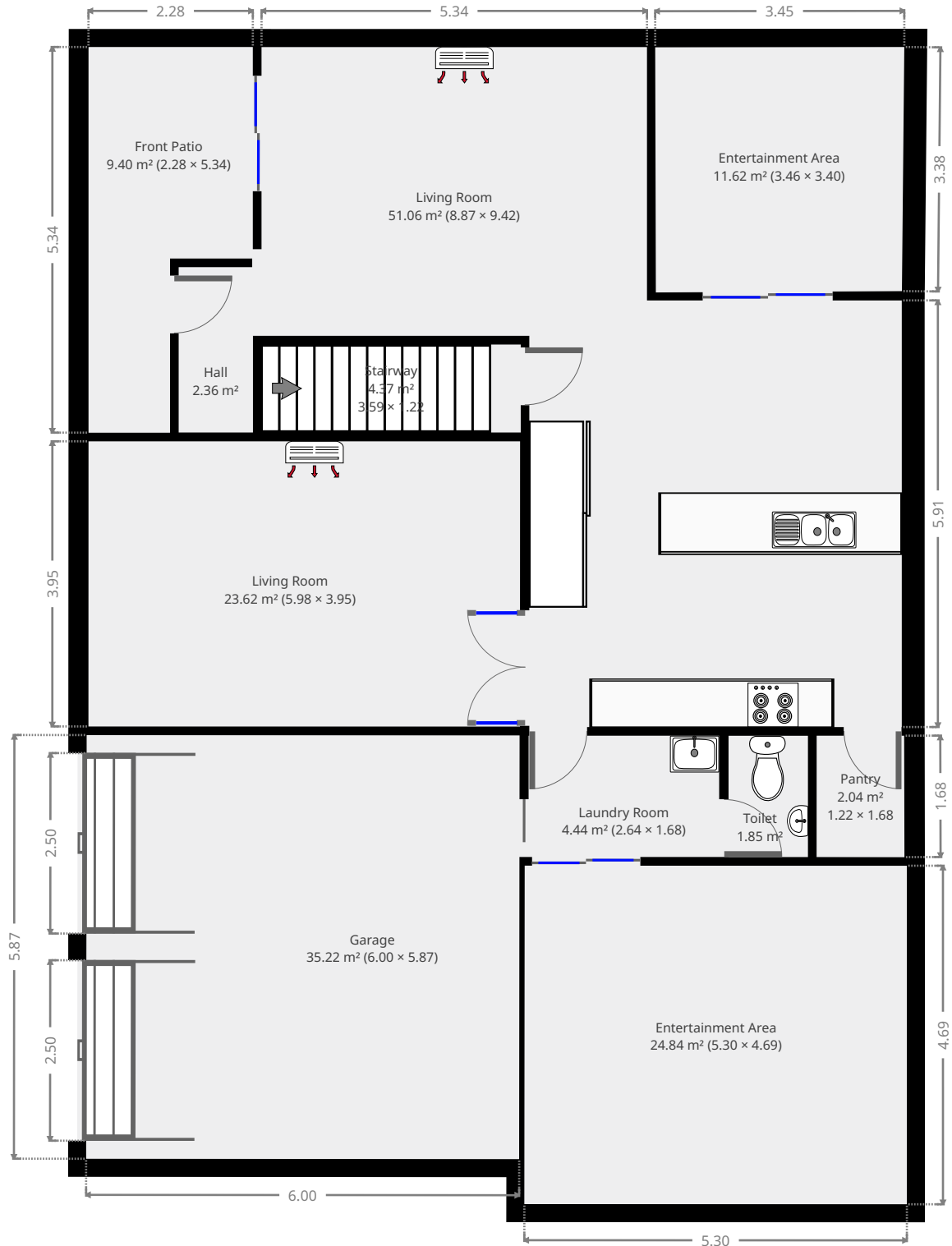

THIS FLOORPLAN IS PROVIDED WITHOUT WARRANTY OF ANY KIND. SENSOPIA DISCLAIMS ANY WARRANTY INCLUDING, WITHOUT LIMITATION, SATISFACTORY QUALITY OR ACCURACY OF DIMENSIONS.

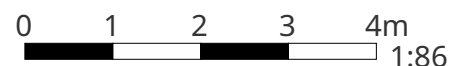

8 Eyre Court

Hall

Width: 1.03 m
 Length: 2.29 m
 Area: 2.36 m²
 Perimeter: 6.64 m

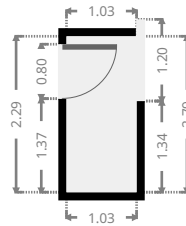
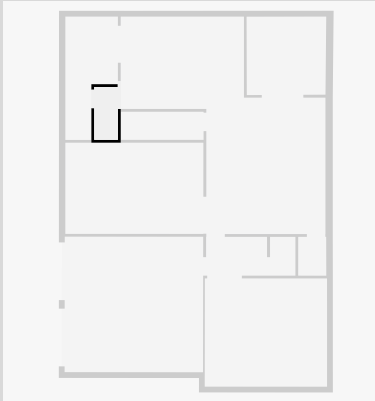

Living Room

Width: 8.87 m
 Length: 9.42 m
 Area: 51.06 m²
 Perimeter: 36.58 m

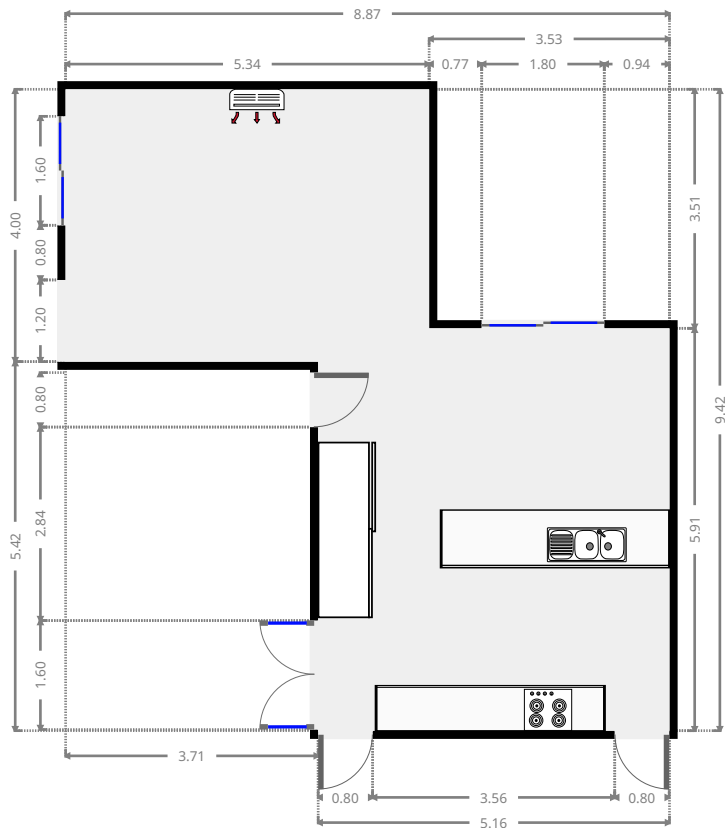
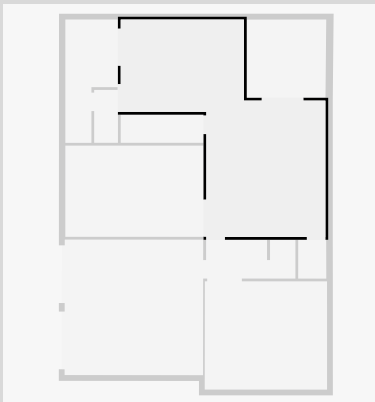

THIS FLOORPLAN IS PROVIDED WITHOUT WARRANTY OF ANY KIND. SENSOPIA DISCLAIMS ANY WARRANTY INCLUDING, WITHOUT LIMITATION, SATISFACTORY QUALITY OR ACCURACY OF DIMENSIONS.

8 Eyre Court

Living Room

Width: 3.95 m
 Length: 5.98 m
 Area: 23.62 m²
 Perimeter: 19.86 m

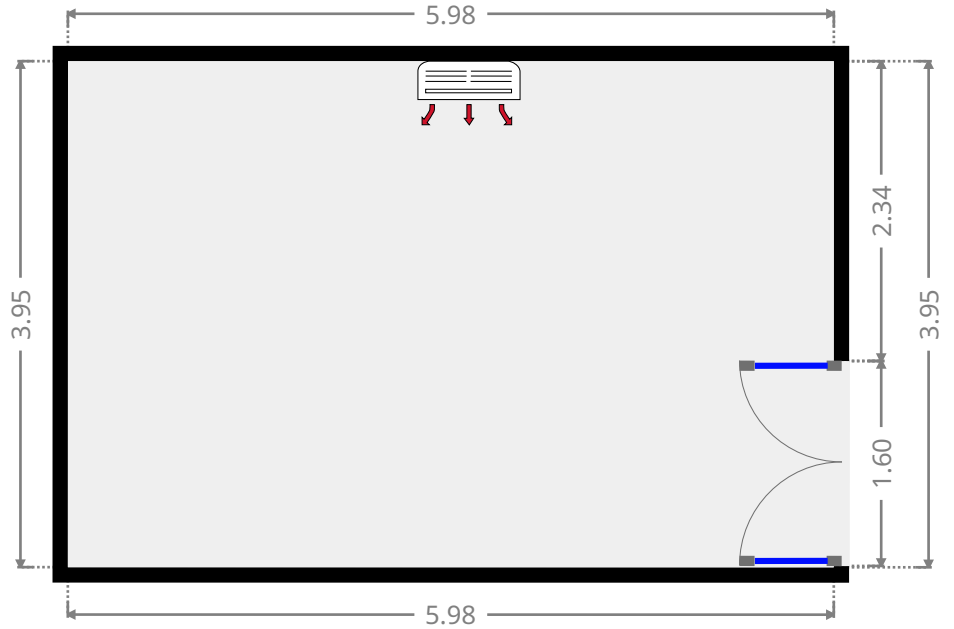
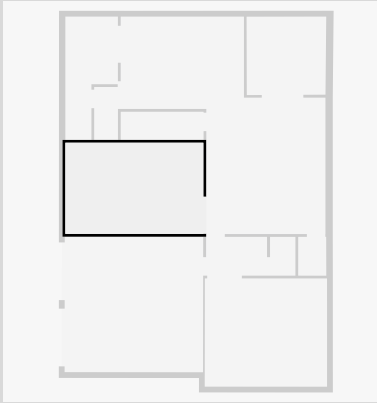

Stairway

Width: 1.22 m
 Length: 3.59 m
 Area: 4.37 m²
 Perimeter: 9.62 m

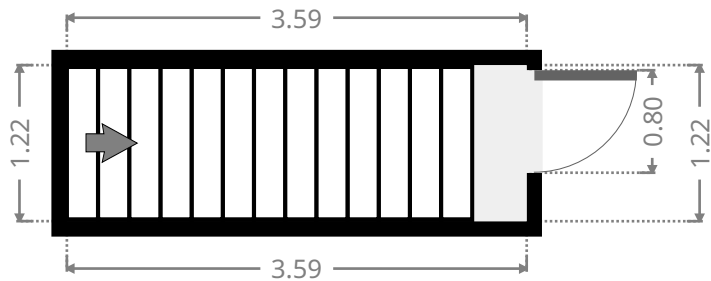
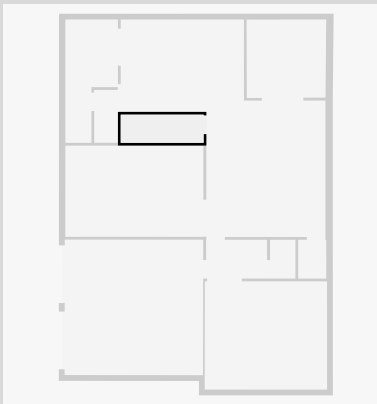

8 Eyre Court

Laundry Room

Width: 1.68 m
 Length: 2.64 m
 Area: 4.44 m²
 Perimeter: 8.64 m

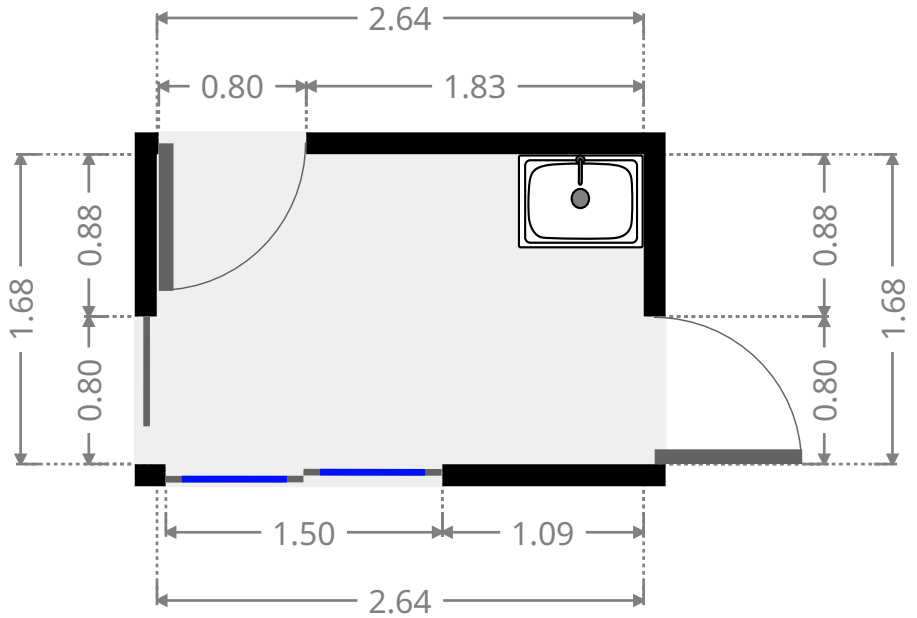
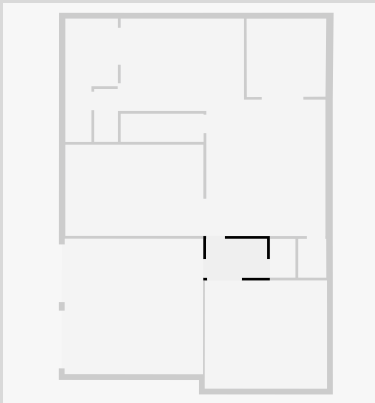

Toilet / Half Bath

Width: 1.10 m
 Length: 1.68 m
 Area: 1.85 m²
 Perimeter: 5.56 m

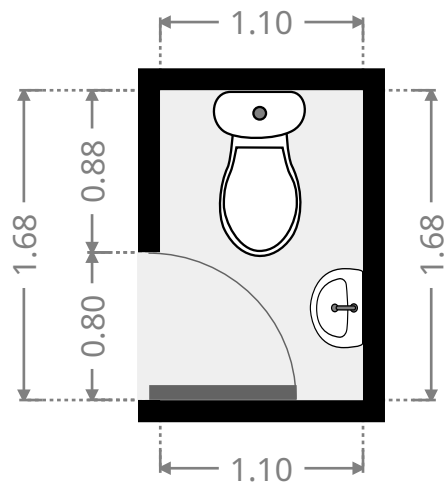
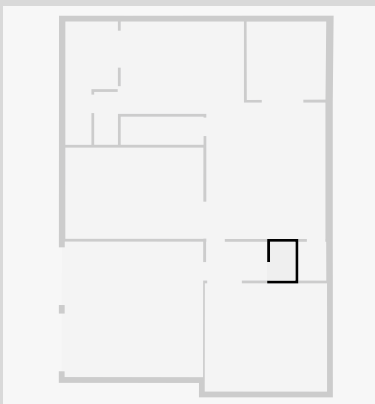

THIS FLOORPLAN IS PROVIDED WITHOUT WARRANTY OF ANY KIND. SENSOPIA DISCLAIMS ANY WARRANTY INCLUDING, WITHOUT LIMITATION, SATISFACTORY QUALITY OR ACCURACY OF DIMENSIONS.

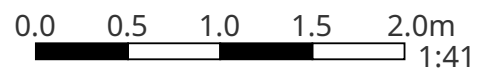

8 Eyre Court

Garage

Width: 5.87 m
 Length: 6.00 m
 Area: 35.22 m²
 Perimeter: 23.74 m

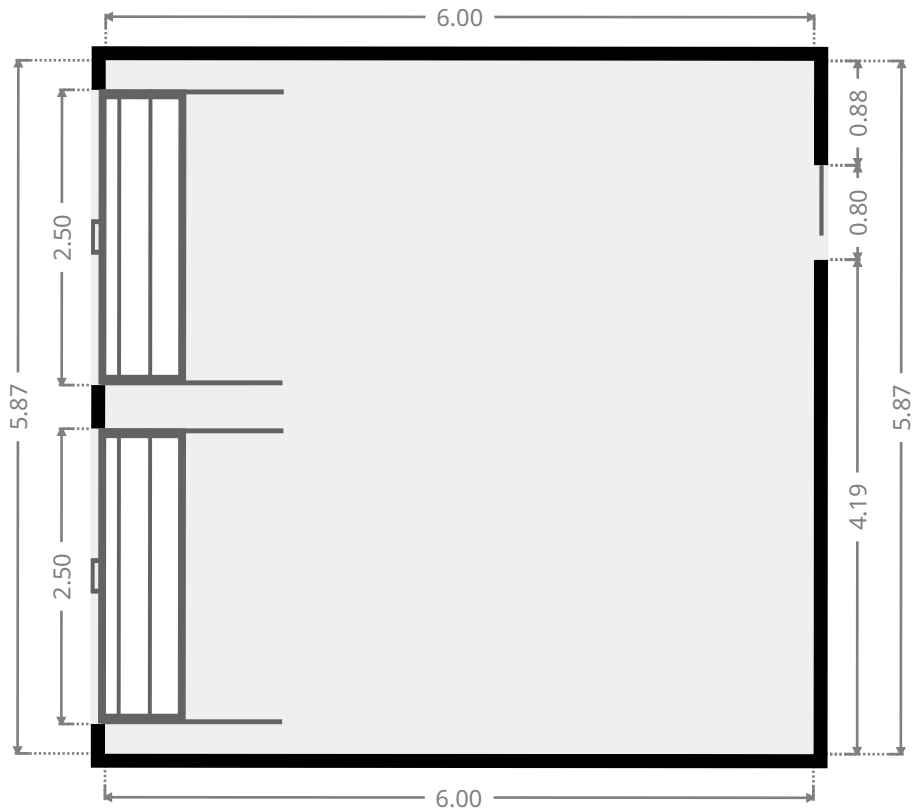
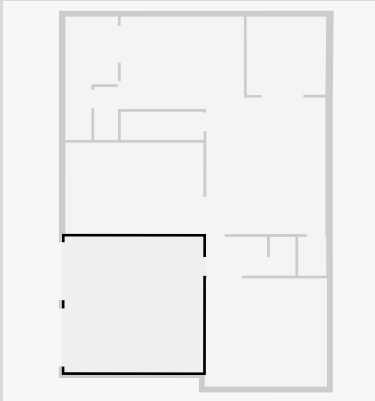

Entertainment Area

Width: 4.69 m
 Length: 5.30 m
 Area: 24.84 m²
 Perimeter: 19.97 m

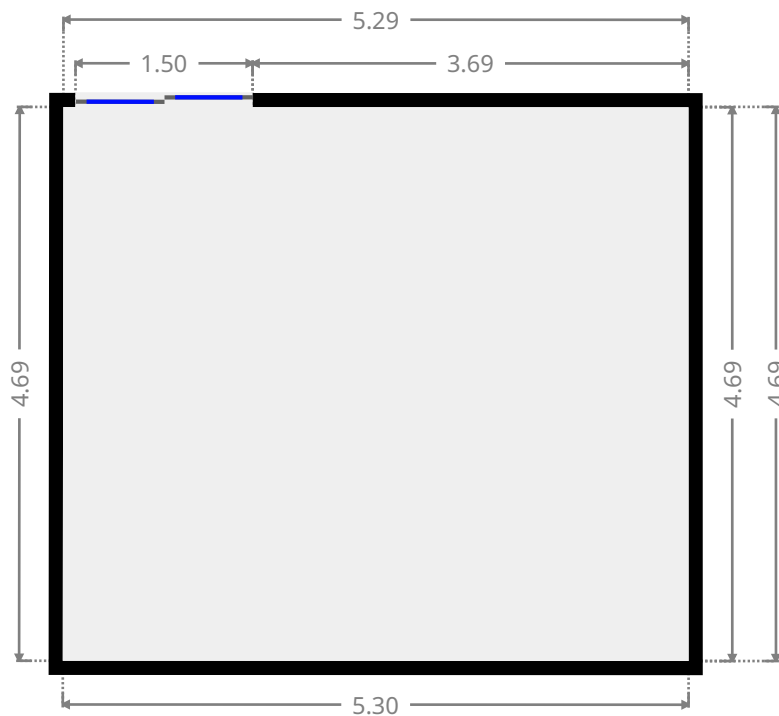
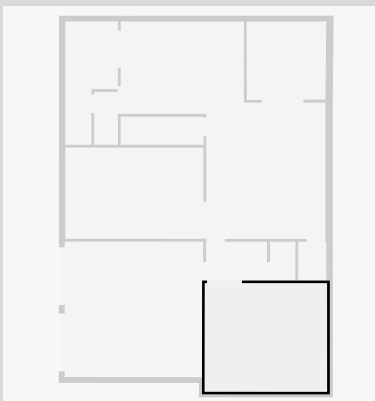

8 Eyre Court

Pantry

Width: 1.22 m
 Length: 1.68 m
 Area: 2.04 m²
 Perimeter: 5.79 m

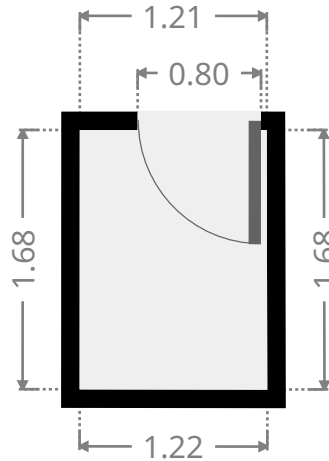
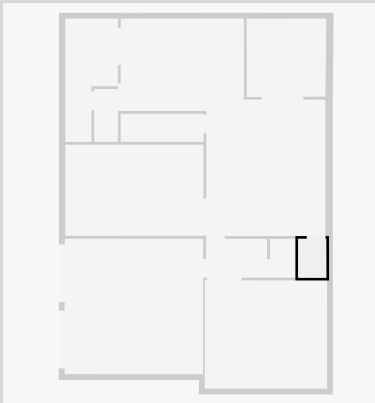

Entertainment Area

Width: 3.40 m
 Length: 3.46 m
 Area: 11.62 m²
 Perimeter: 13.64 m

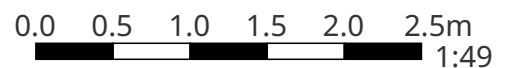
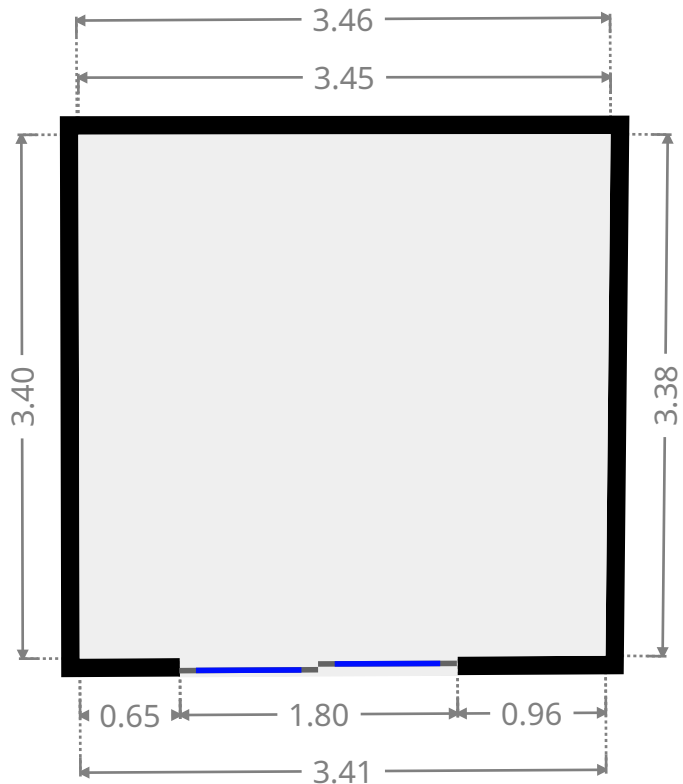
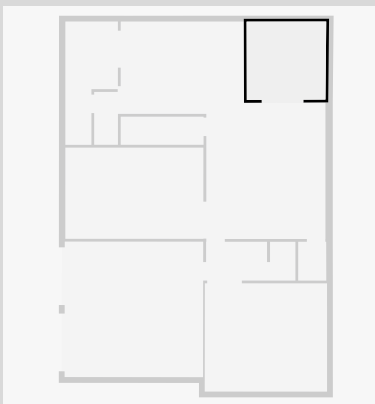

THIS FLOORPLAN IS PROVIDED WITHOUT WARRANTY OF ANY KIND. SENSOPIA DISCLAIMS ANY WARRANTY INCLUDING, WITHOUT LIMITATION, SATISFACTORY QUALITY OR ACCURACY OF DIMENSIONS.

8 Eyre Court

Front Patio

Width: 2.28 m
Length: 5.34 m
Area: 9.40 m²
Perimeter: 15.24 m

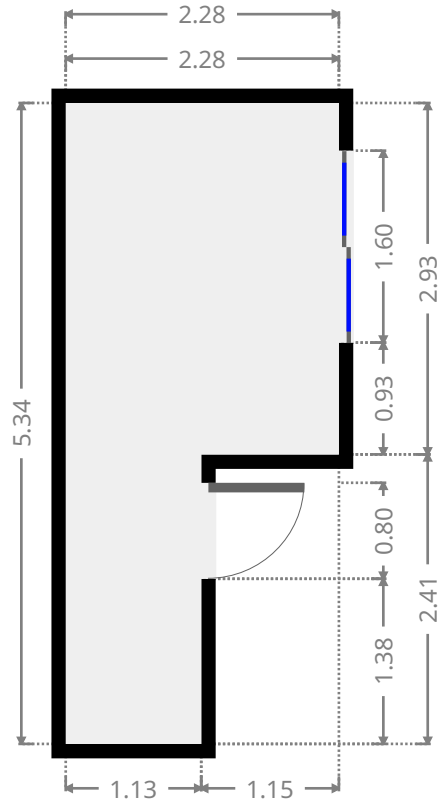
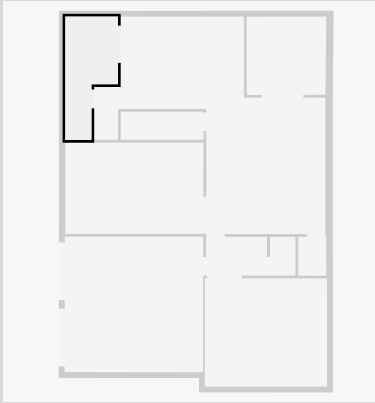

8 Eyre Court

1st Floor



THIS FLOORPLAN IS PROVIDED WITHOUT WARRANTY OF ANY KIND. SENSOPIA DISCLAIMS ANY WARRANTY INCLUDING, WITHOUT LIMITATION, SATISFACTORY QUALITY OR ACCURACY OF DIMENSIONS.



8 Eyre Court

Living Room

Width: 4.49 m
 Length: 6.80 m
 Area: 27.27 m²
 Perimeter: 22.58 m

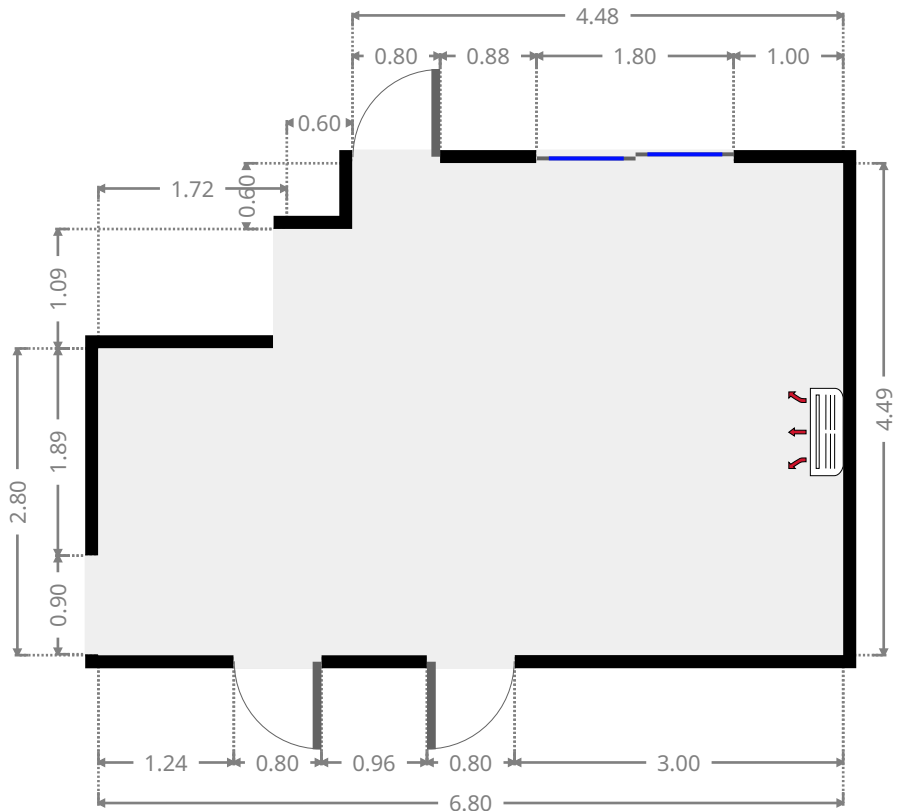
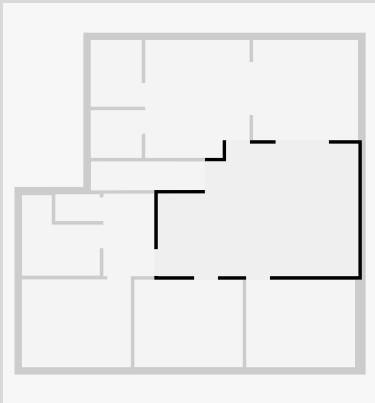

Bedroom

Width: 2.97 m
 Length: 3.69 m
 Area: 10.96 m²
 Perimeter: 13.32 m

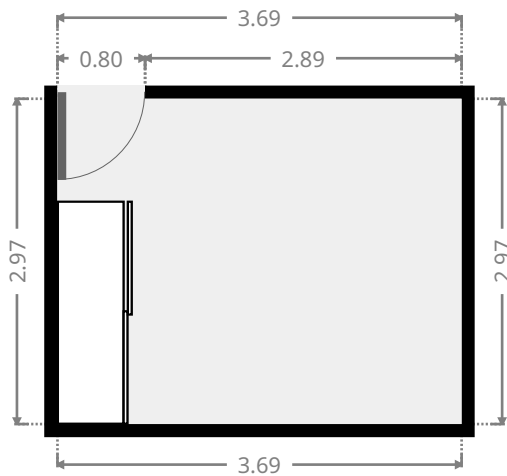
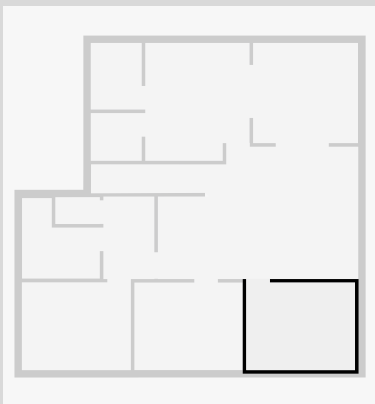

8 Eyre Court

Bedroom

Width: 2.97 m
 Length: 3.68 m
 Area: 10.93 m²
 Perimeter: 13.30 m

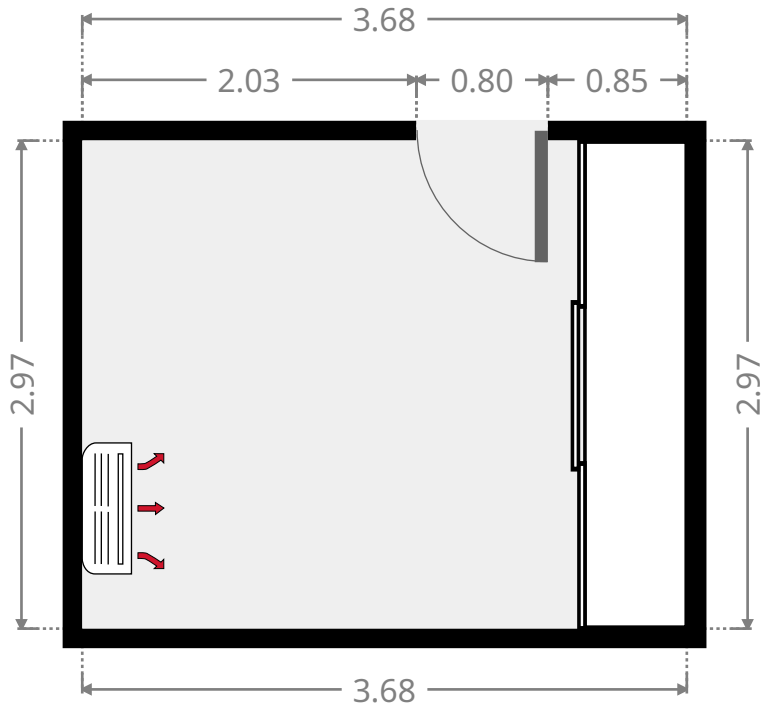
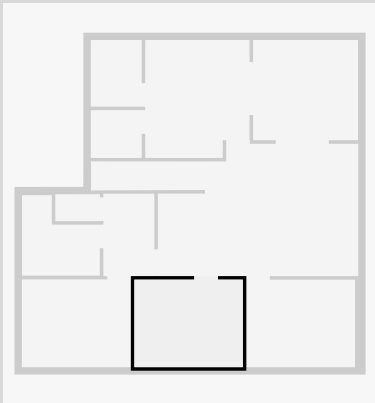

Hall

Width: 1.73 m
 Length: 2.80 m
 Area: 4.84 m²
 Perimeter: 9.06 m

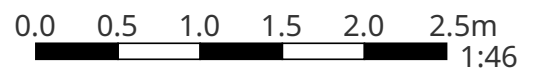
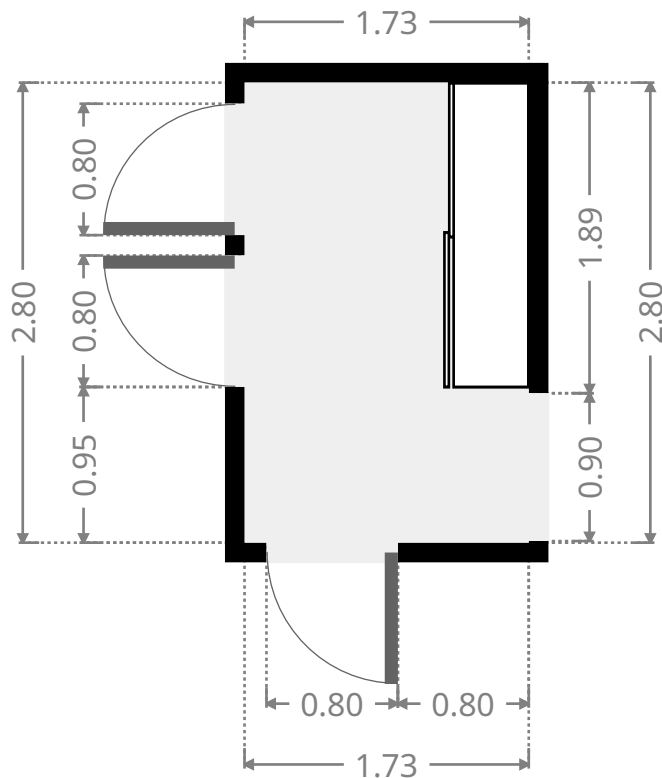
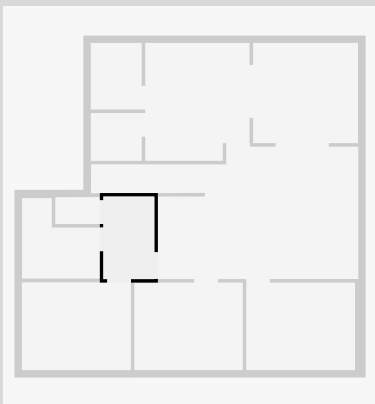

THIS FLOORPLAN IS PROVIDED WITHOUT WARRANTY OF ANY KIND. SENSOPIA DISCLAIMS ANY WARRANTY INCLUDING, WITHOUT LIMITATION, SATISFACTORY QUALITY OR ACCURACY OF DIMENSIONS.

8 Eyre Court

Bedroom

Width: 2.98 m
 Length: 3.70 m
 Area: 11.03 m²
 Perimeter: 13.36 m

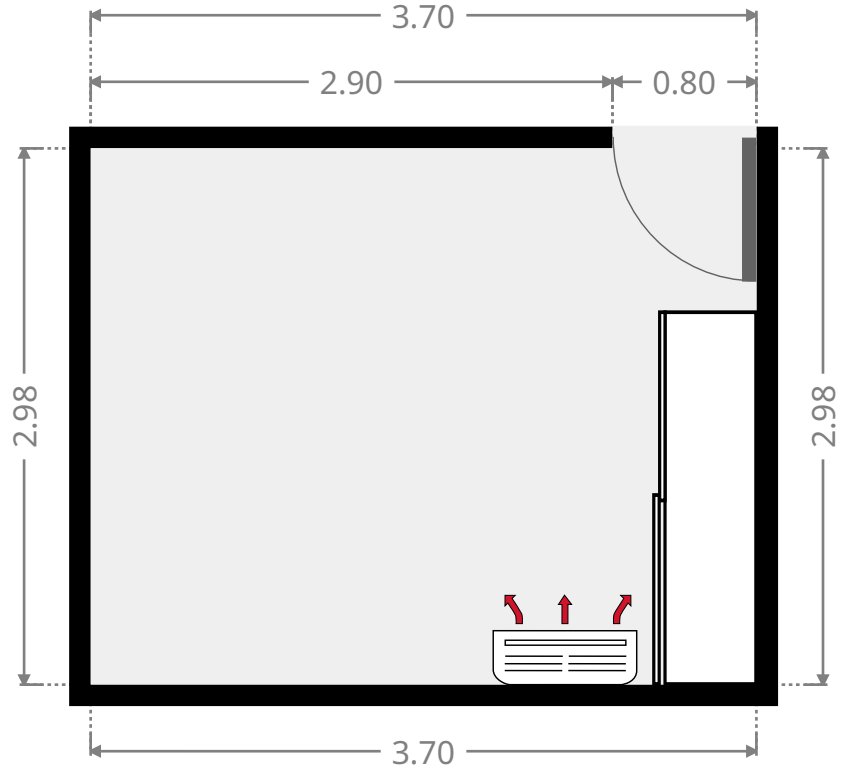
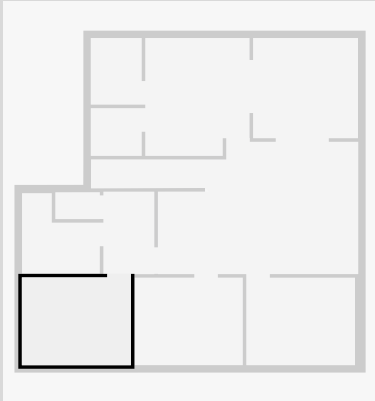

Bathroom

Width: 2.64 m
 Length: 2.73 m
 Area: 5.58 m²
 Perimeter: 10.74 m

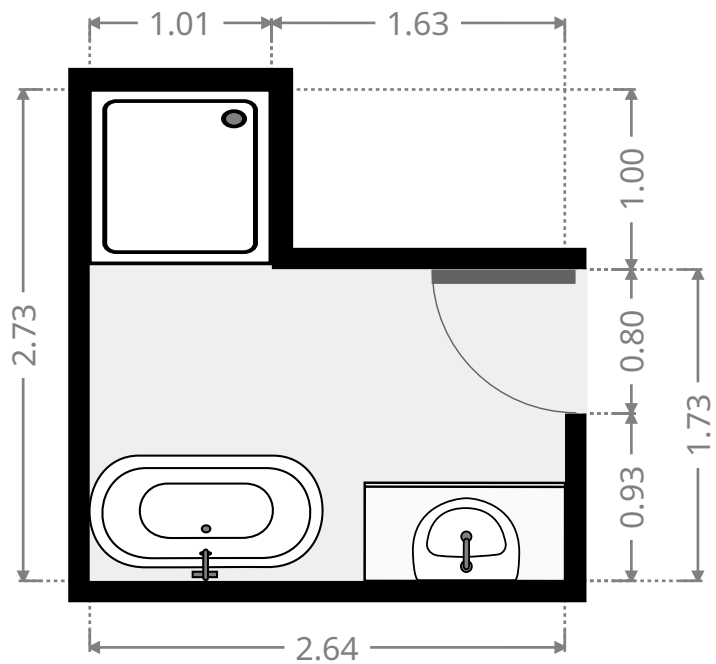
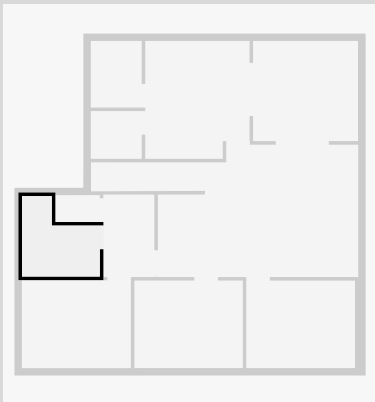

8 Eyre Court

Toilet / Half Bath

Width: 0.91 m
 Length: 1.51 m
 Area: 1.38 m²
 Perimeter: 4.84 m

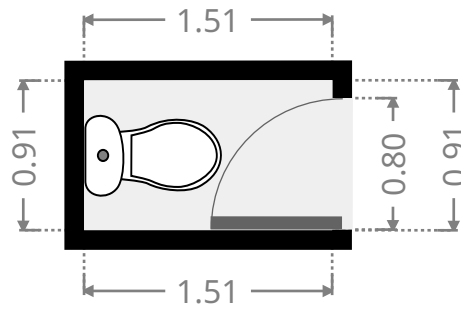
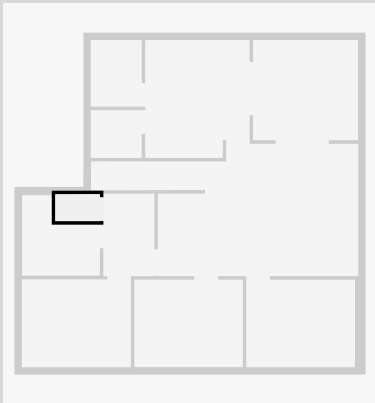

Outdoor Area

Width: 3.40 m
 Length: 3.56 m
 Area: 12.10 m²
 Perimeter: 13.92 m

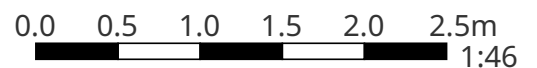
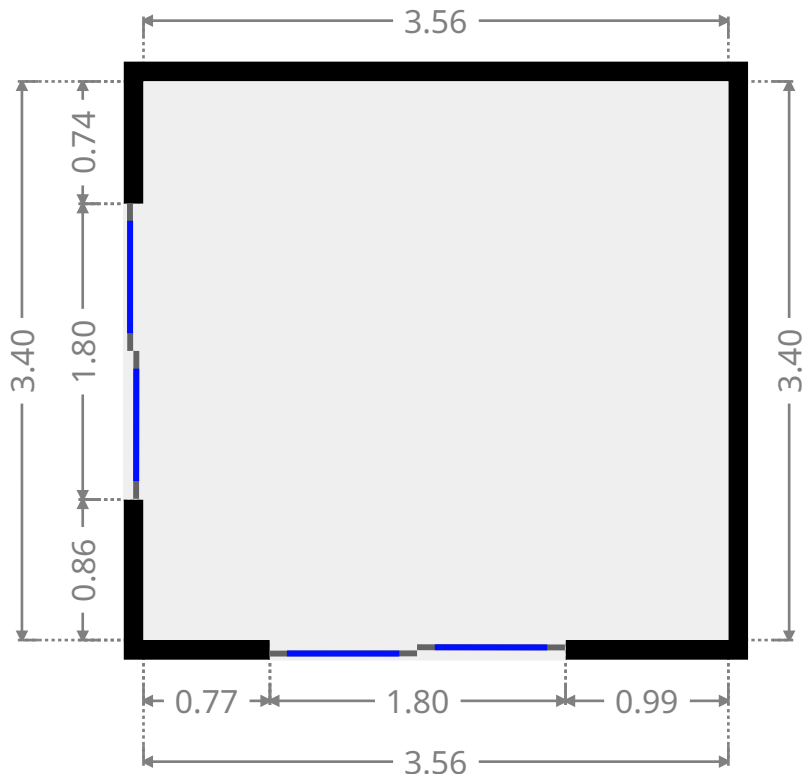
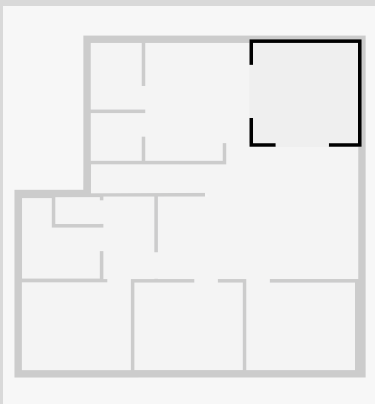

THIS FLOORPLAN IS PROVIDED WITHOUT WARRANTY OF ANY KIND. SENSOPIA DISCLAIMS ANY WARRANTY INCLUDING, WITHOUT LIMITATION, SATISFACTORY QUALITY OR ACCURACY OF DIMENSIONS.

8 Eyre Court

Master Bedroom

Width: 3.54 m
 Length: 4.00 m
 Area: 13.61 m²
 Perimeter: 15.08 m

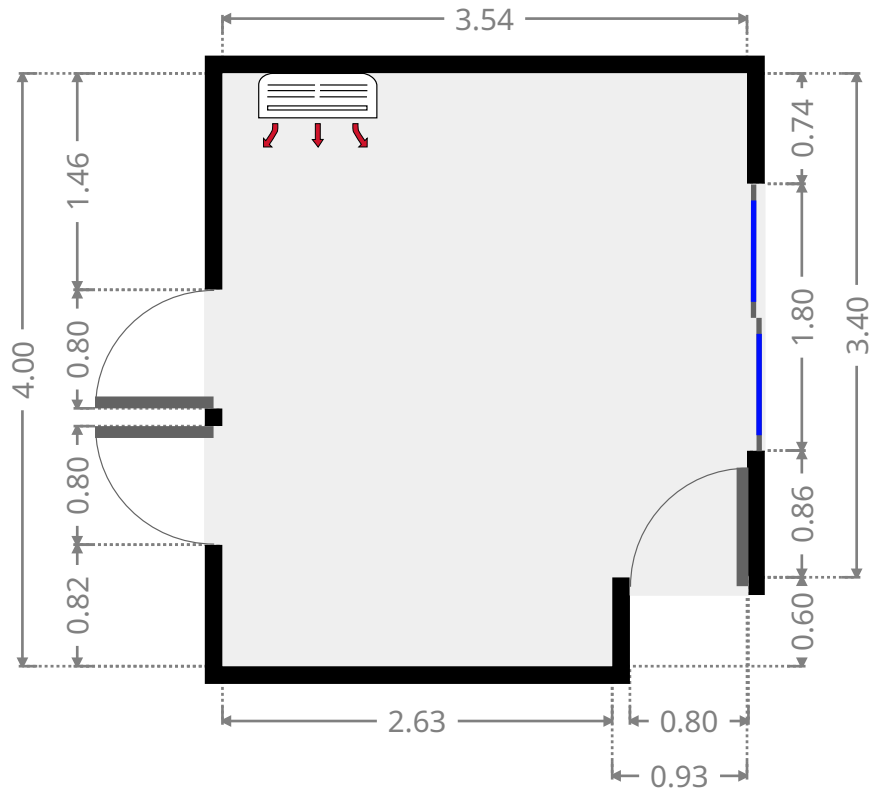
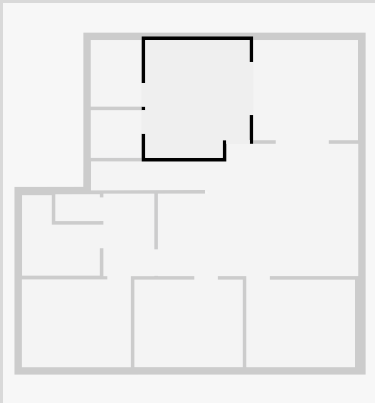

Bathroom

Width: 1.73 m
 Length: 2.26 m
 Area: 3.91 m²
 Perimeter: 7.98 m

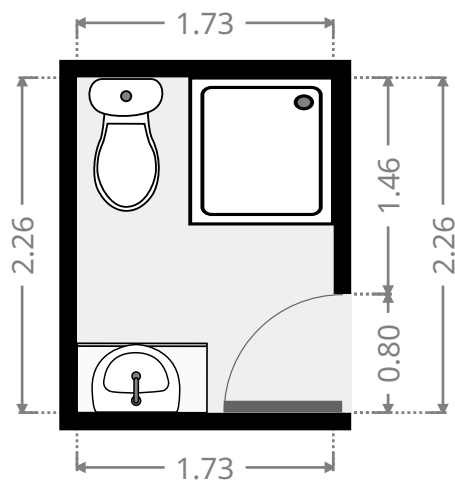
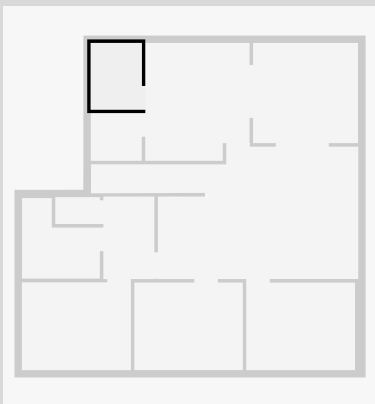

8 Eyre Court

Closet

Width: 1.62 m
 Length: 1.73 m
 Area: 2.80 m²
 Perimeter: 6.70 m

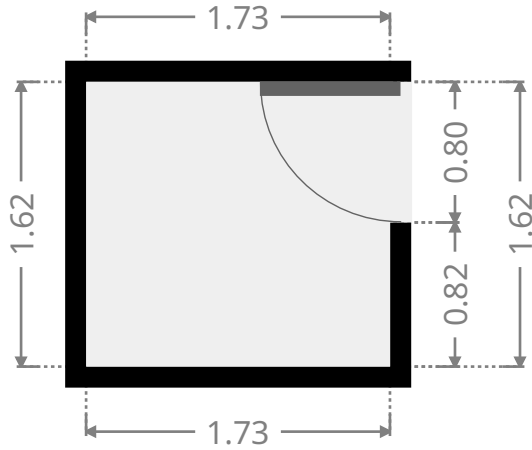
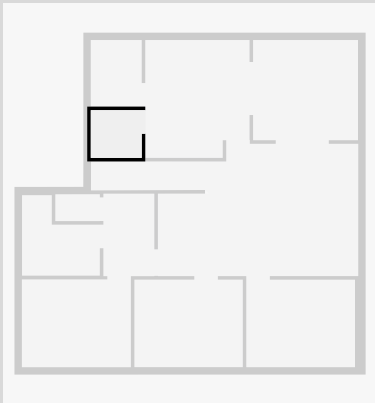

Stairway

Width: 0.99 m
 Length: 3.87 m
 Area: 3.78 m²
 Perimeter: 9.69 m

