

8 Edenbrook Drive

Created on
2020-11-19

Floors
1

▼ Ground Floor



FLOORS:1

▼ Hall
Ground Floor

WIDTH:7.22 m · LENGTH:13.66 m
AREA:45.25 m² · PERIMETER:41.75 m

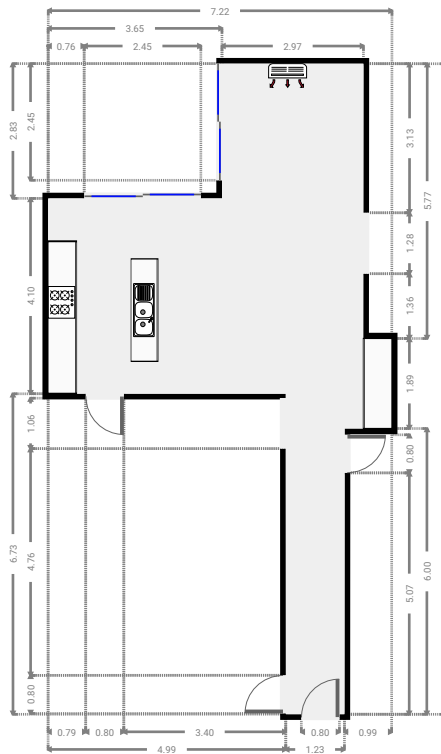
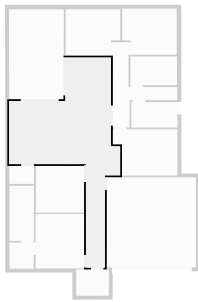

▼ Master Bedroom
Ground Floor

WIDTH:3.15 m · LENGTH:3.54 m
AREA:11.15 m² · PERIMETER:13.38 m

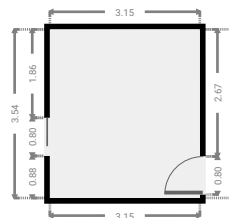

FLOORS:1

▼ **Closet**
Ground Floor

WIDTH:1.57 m · LENGTH:1.70 m
AREA:2.67 m² · PERIMETER:6.54 m

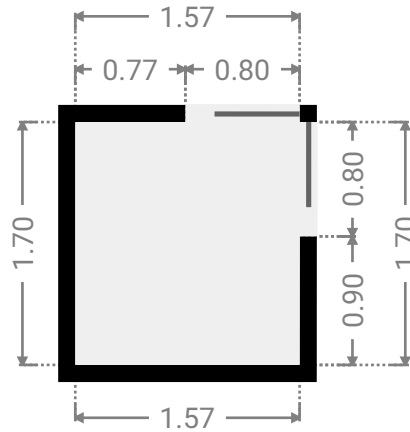
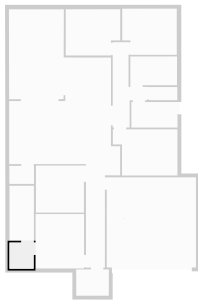

▼ **Bathroom**
Ground Floor

WIDTH:1.59 m · LENGTH:3.58 m
AREA:5.68 m² · PERIMETER:10.33 m

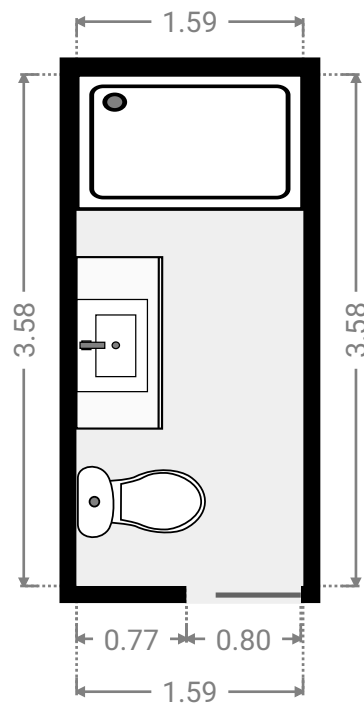
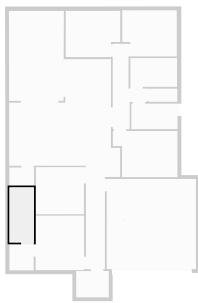

FLOORS:1

▼ **Living Room**
Ground Floor

WIDTH:3.12 m · LENGTH:3.06 m
AREA:9.55 m² · PERIMETER:12.36 m

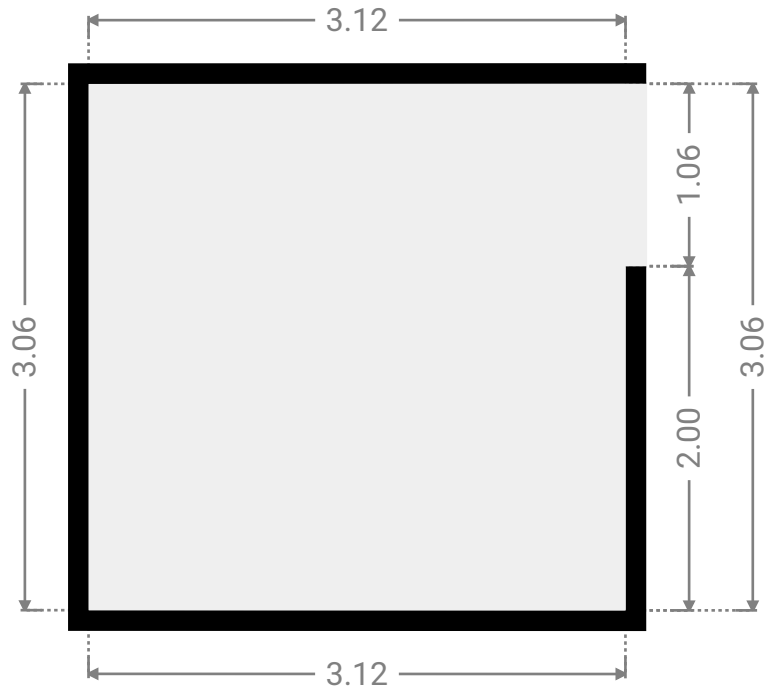
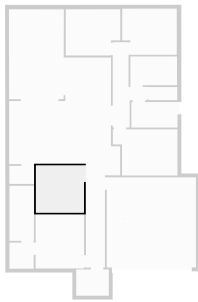

▼ **Closet**
Ground Floor

WIDTH:1.61 m · LENGTH:1.17 m
AREA:1.88 m² · PERIMETER:5.55 m

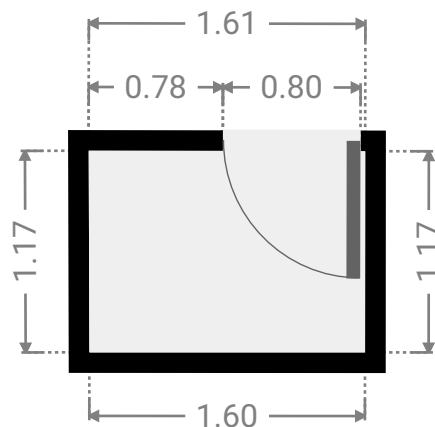
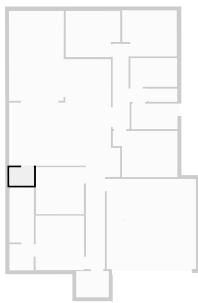

▼ **Hall**
Ground Floor

WIDTH:2.23 m · LENGTH:5.55 m
AREA:6.87 m² · PERIMETER:15.55 m

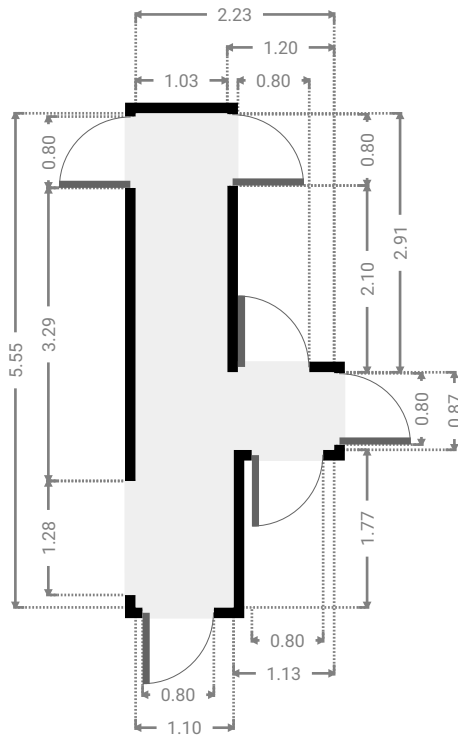

▼ **Bedroom**
Ground Floor

WIDTH:4.20 m · LENGTH:3.00 m
AREA:11.40 m² · PERIMETER:14.40 m

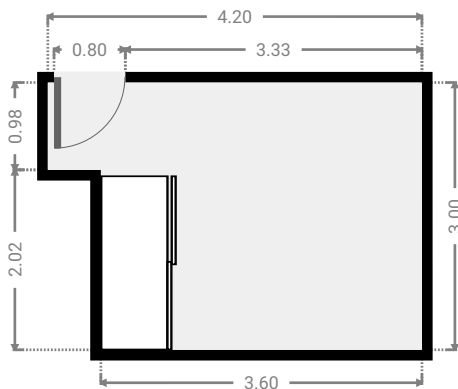
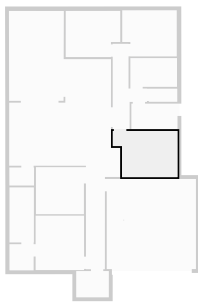

FLOORS:1

▼ **Laundry Room**
Ground Floor

WIDTH:3.00 m · LENGTH:1.66 m
AREA:4.98 m² · PERIMETER:9.32 m

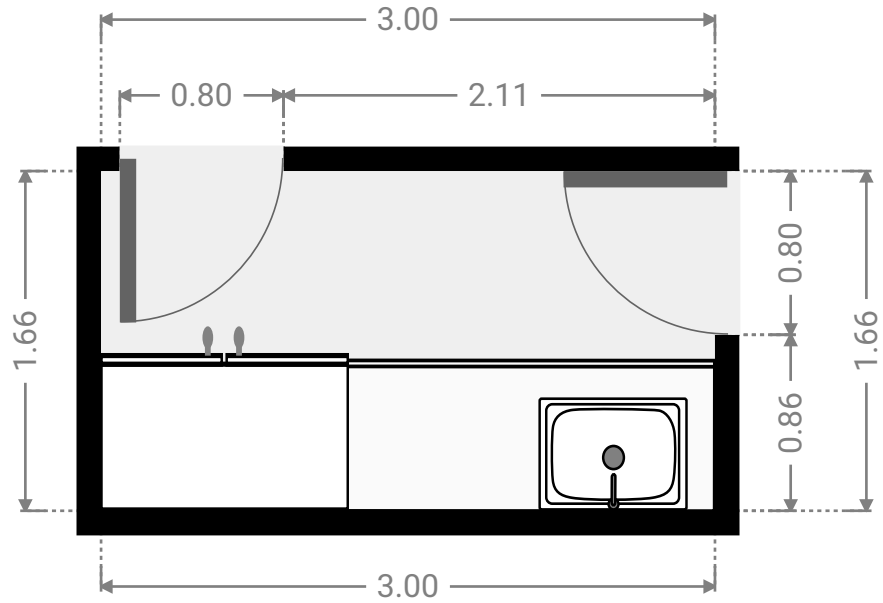
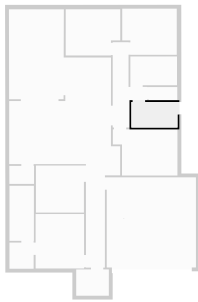

▼ **Toilet**
Ground Floor

WIDTH:1.85 m · LENGTH:0.85 m
AREA:1.58 m² · PERIMETER:5.40 m

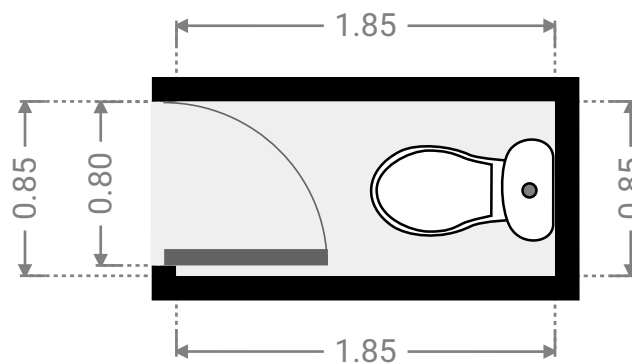
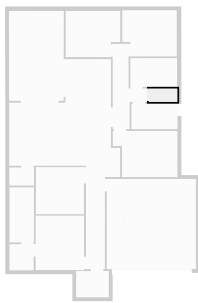

▼ **Bathroom**
Ground Floor

WIDTH:3.03 m · LENGTH:1.87 m
AREA:5.67 m² · PERIMETER:9.81 m

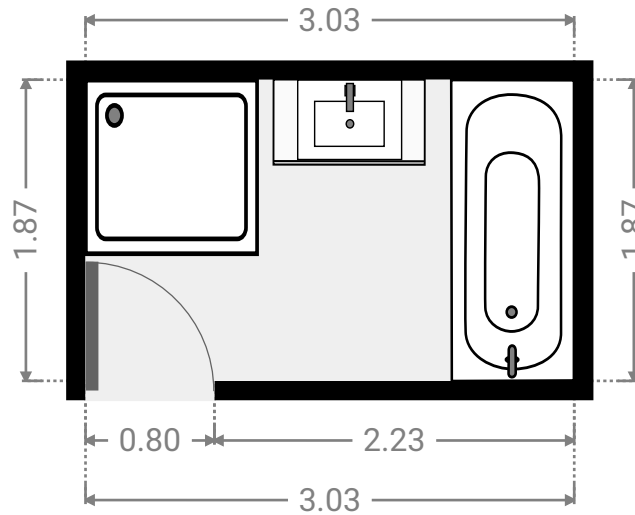
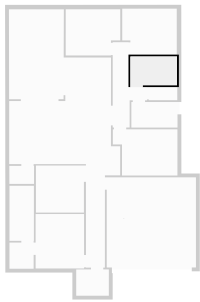

▼ **Bedroom**
Ground Floor

WIDTH:3.55 m · LENGTH:3.00 m
AREA:10.14 m² · PERIMETER:13.09 m

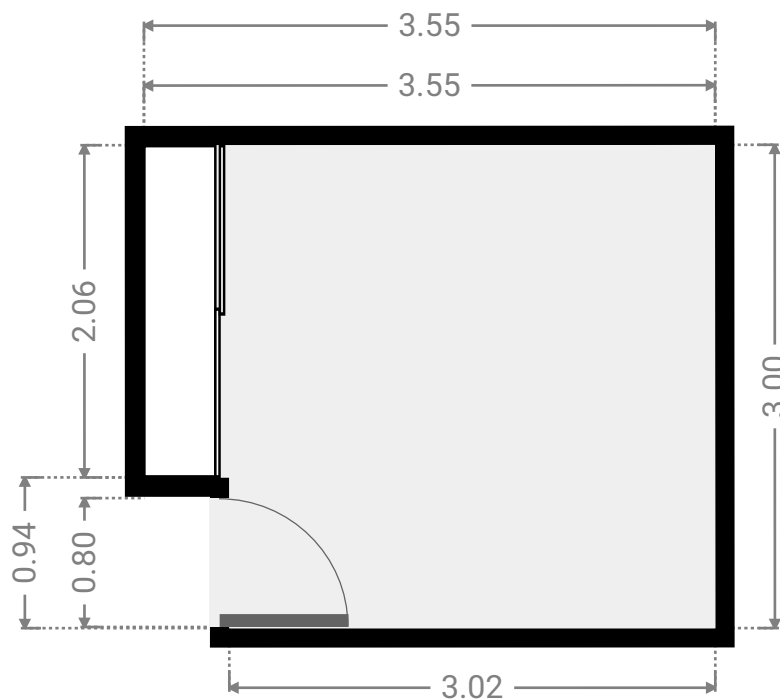
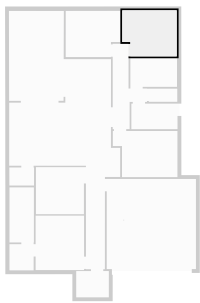

FLOORS:1

▼ **Bedroom**

Ground Floor

WIDTH:3.55 m · LENGTH:3.00 m
AREA:10.05 m² · PERIMETER:13.09 m

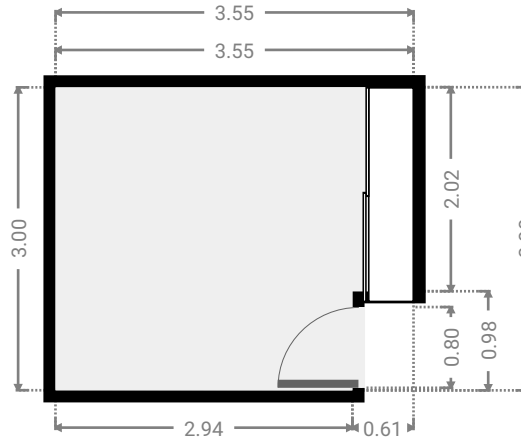

▼ **Garage**

Ground Floor

WIDTH:5.80 m · LENGTH:5.86 m
AREA:33.99 m² · PERIMETER:23.32 m

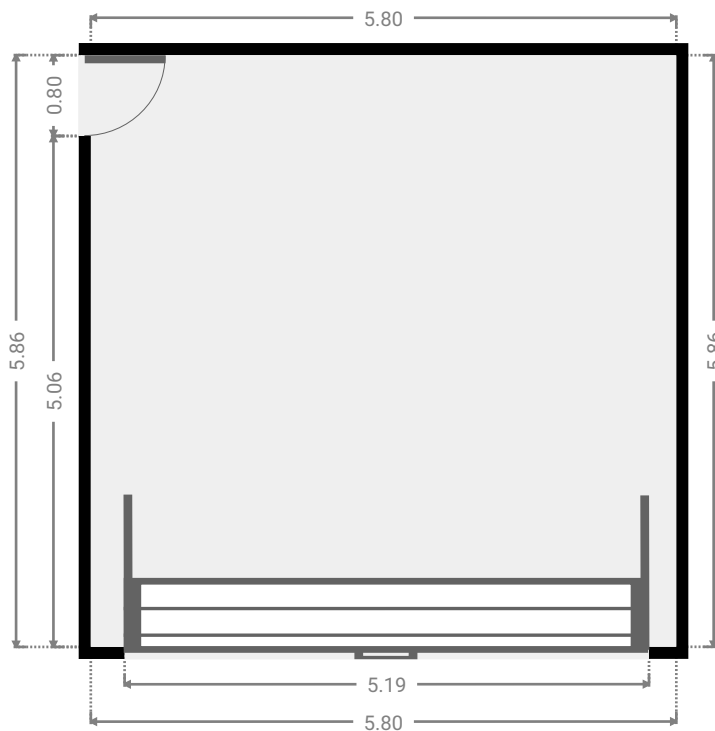
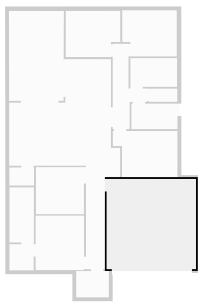

FLOORS:1

▼ Other
Ground Floor

WIDTH:3.57 m · LENGTH:5.85 m
AREA:20.78 m² · PERIMETER:18.80 m

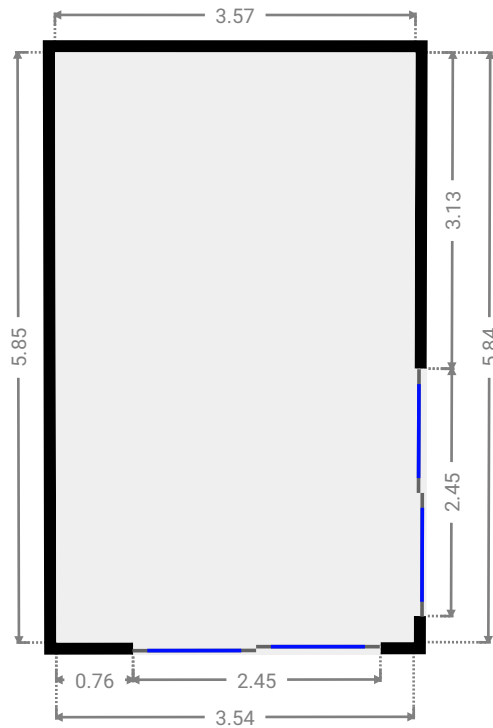
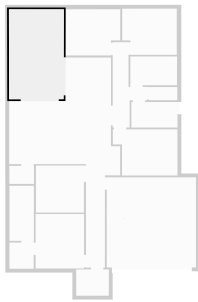

▼ Other
Ground Floor

WIDTH:2.12 m · LENGTH:1.71 m
AREA:3.62 m² · PERIMETER:7.65 m

