

8 DANKER Street

SUBMITTED BY

Ray White Rockhampton Casey
stockers@cqoz.com

CREATED ON

2022-05-24

Floors

2

▼ Ground Floor

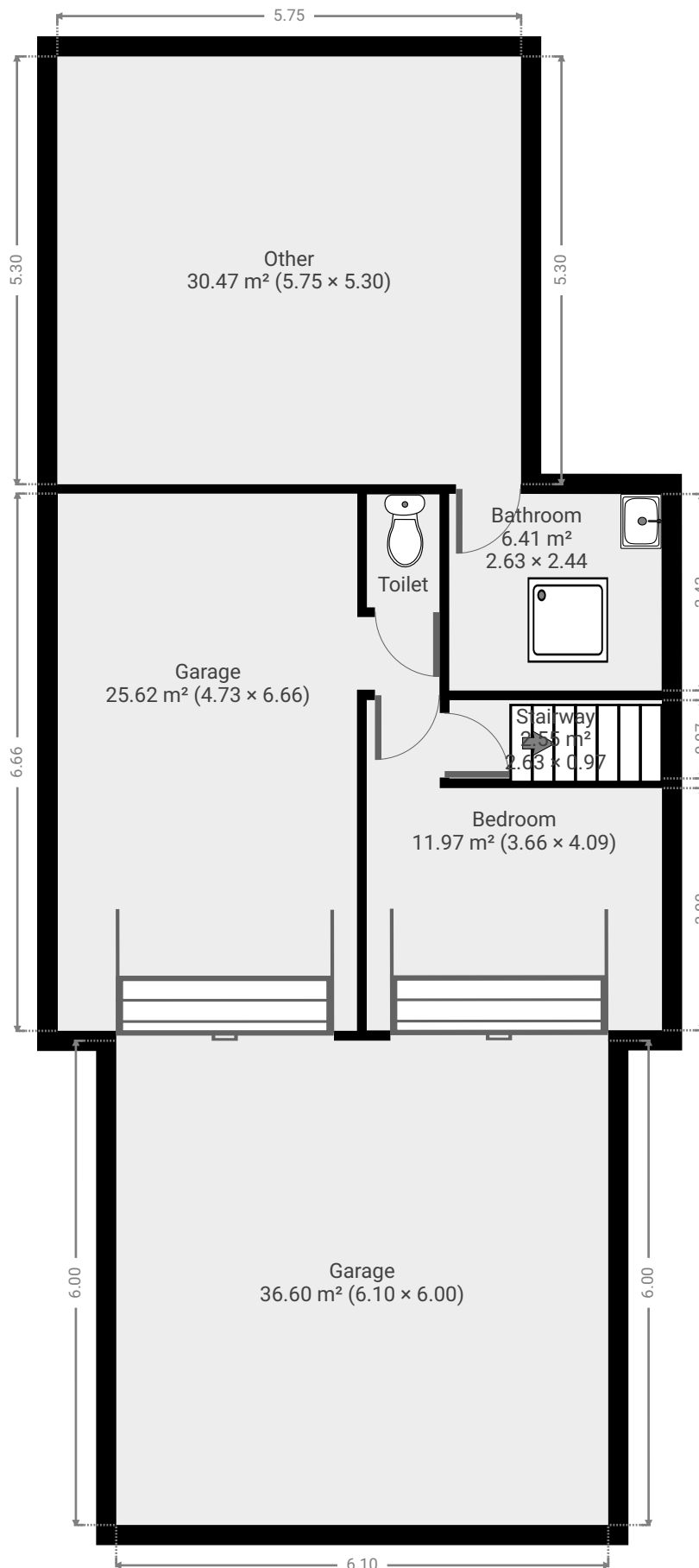

▼ **Bathroom**
Ground Floor

WIDTH: 2.63 m • LENGTH: 2.44 m
AREA: 6.41 m² • PERIMETER: 10.14 m

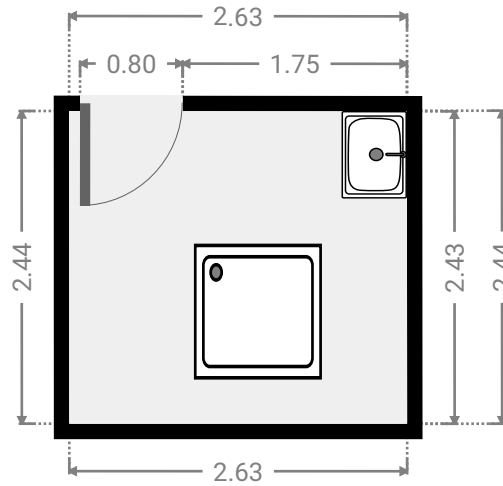
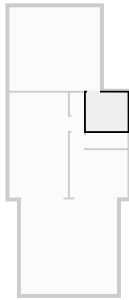

▼ **Bedroom**
Ground Floor

WIDTH: 3.66 m • LENGTH: 4.09 m
AREA: 11.97 m² • PERIMETER: 15.50 m

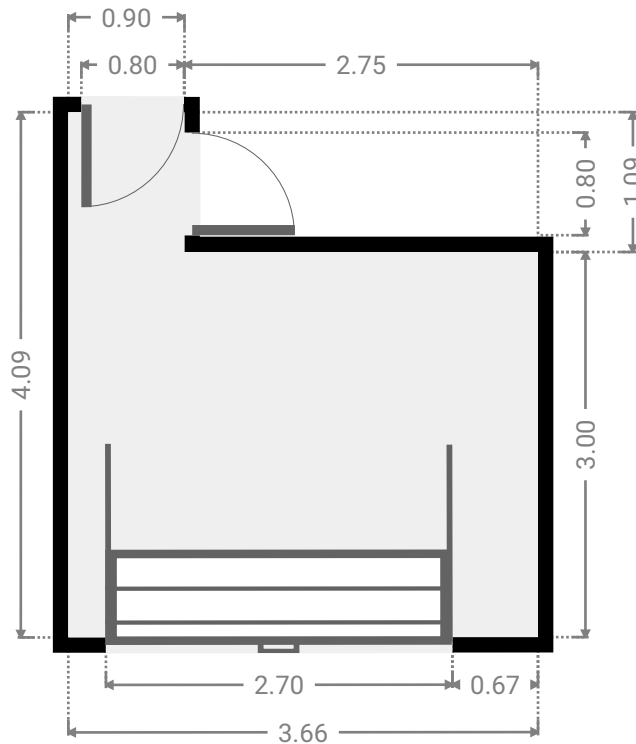
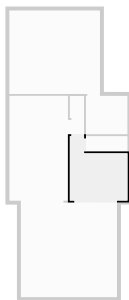

FLOORS: 2

▼ **Garage**
Ground Floor

WIDTH: 4.73 m • LENGTH: 6.68 m
AREA: 25.62 m² • PERIMETER: 22.78 m

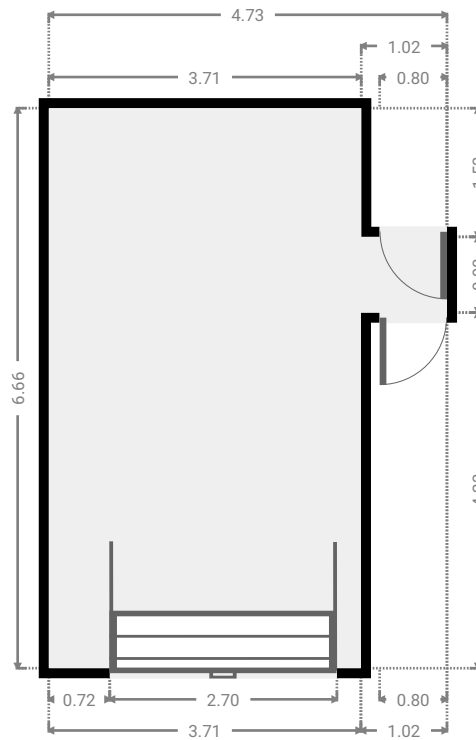
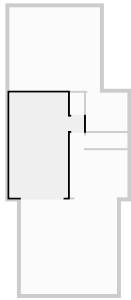

▼ **Garage**
Ground Floor

WIDTH: 6.10 m • LENGTH: 6.00 m
AREA: 36.60 m² • PERIMETER: 24.20 m

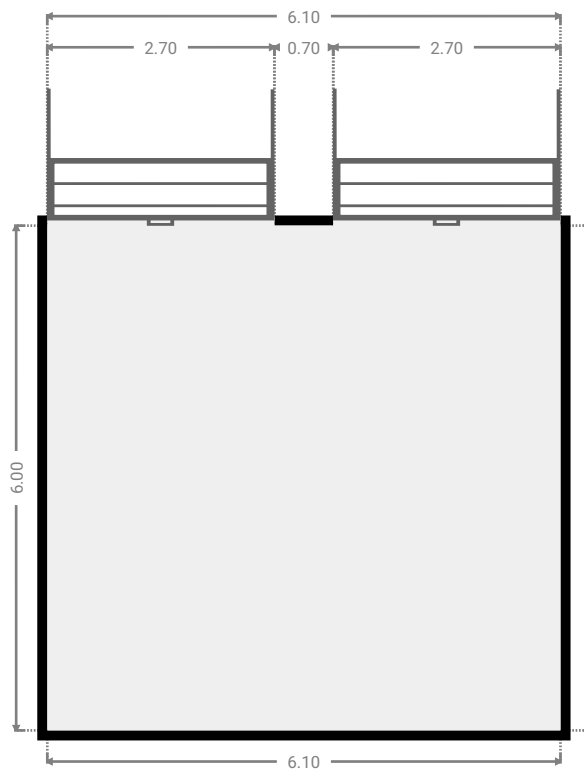
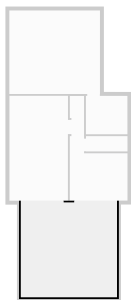

▼ **Other**
Ground Floor

WIDTH: 5.75 m • LENGTH: 5.30 m
AREA: 30.47 m² • PERIMETER: 22.10 m

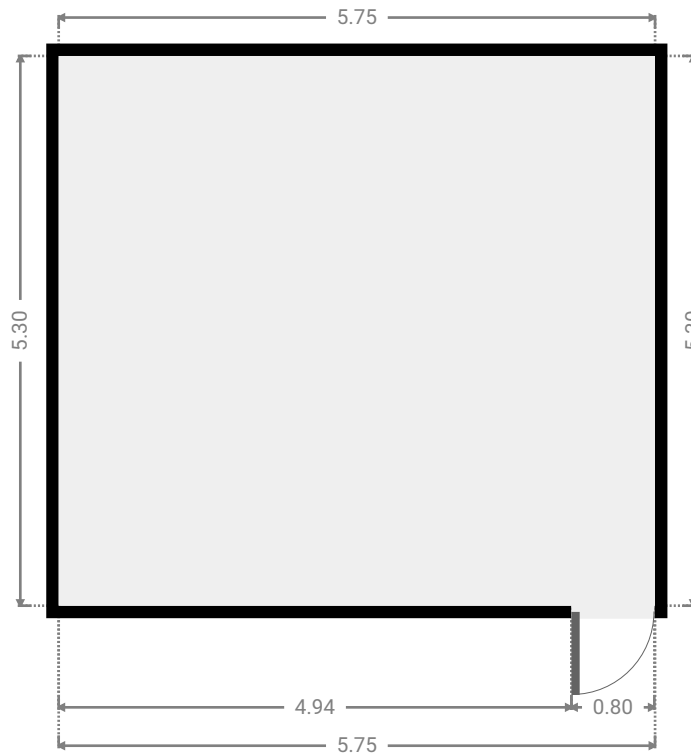
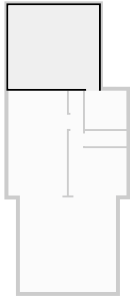

▼ **Stairway**
Ground Floor

WIDTH: 2.63 m • LENGTH: 0.97 m
AREA: 2.55 m² • PERIMETER: 7.21 m

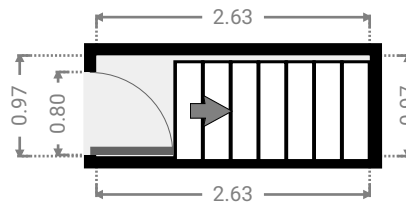
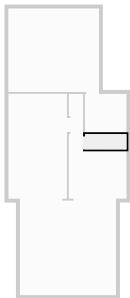

▼ Toilet
Ground Floor

WIDTH: 0.90 m • LENGTH: 1.40 m
AREA: 1.26 m² • PERIMETER: 4.60 m

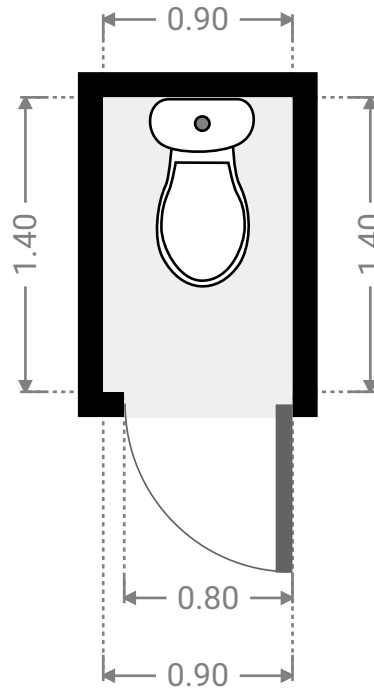
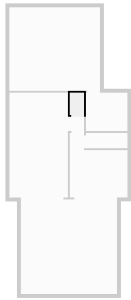

▼ 1st Floor

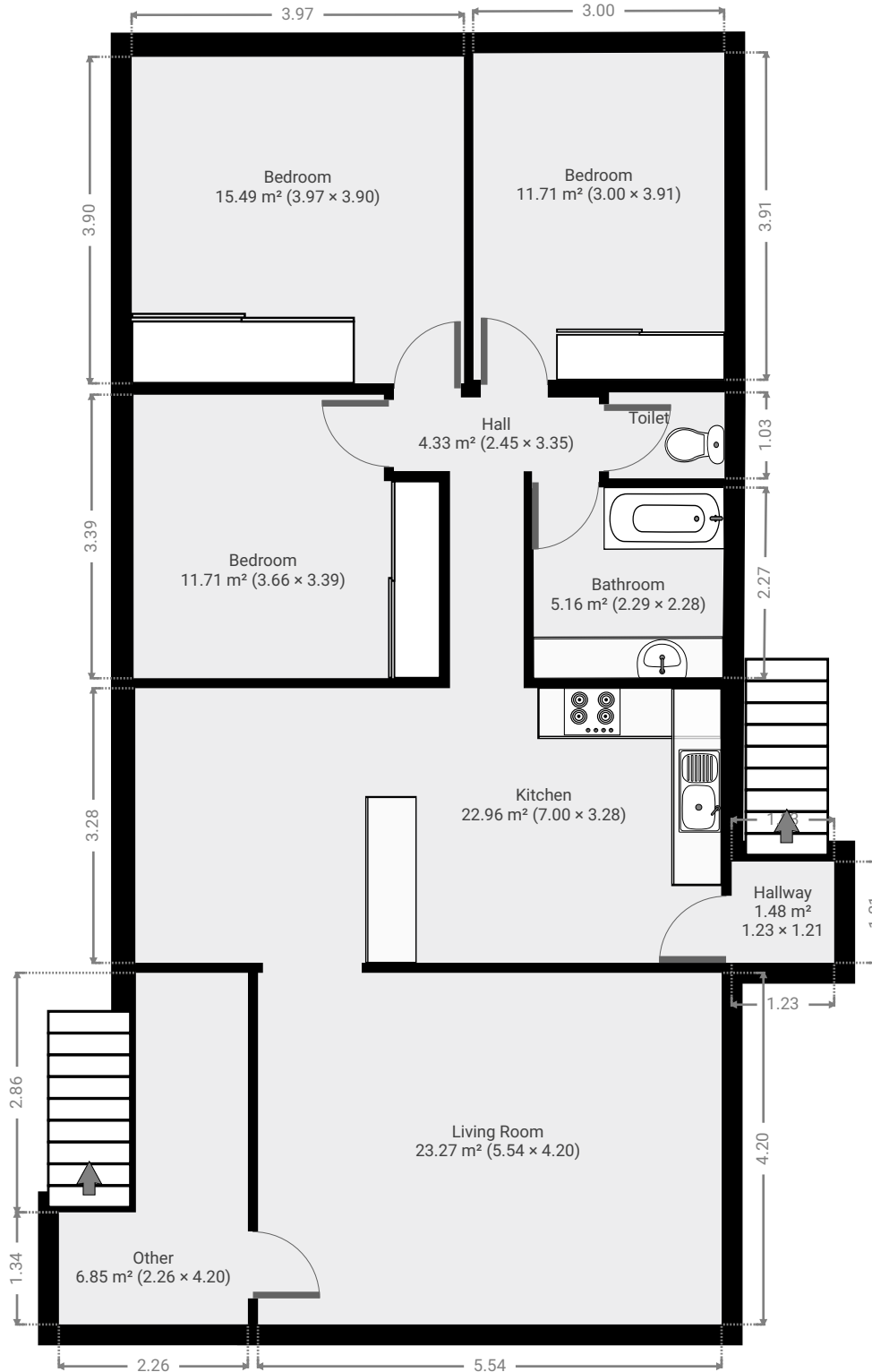

▼ **Bathroom**
1st Floor

WIDTH: 2.28 m • LENGTH: 2.29 m
AREA: 5.16 m² • PERIMETER: 9.09 m

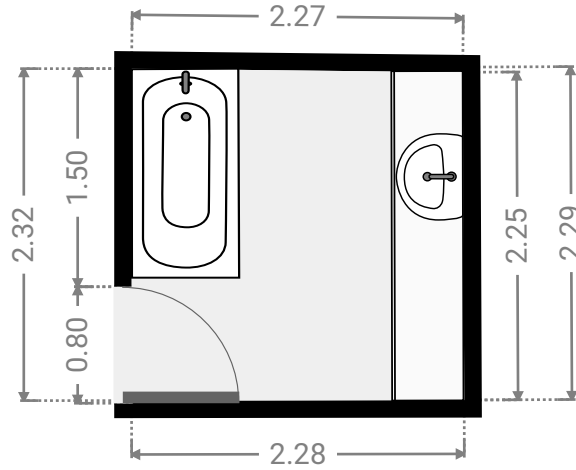
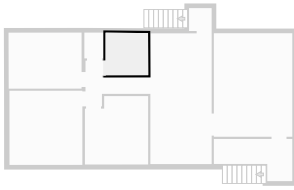

▼ **Bedroom**
1st Floor

WIDTH: 3.39 m • LENGTH: 3.66 m
AREA: 11.71 m² • PERIMETER: 14.10 m

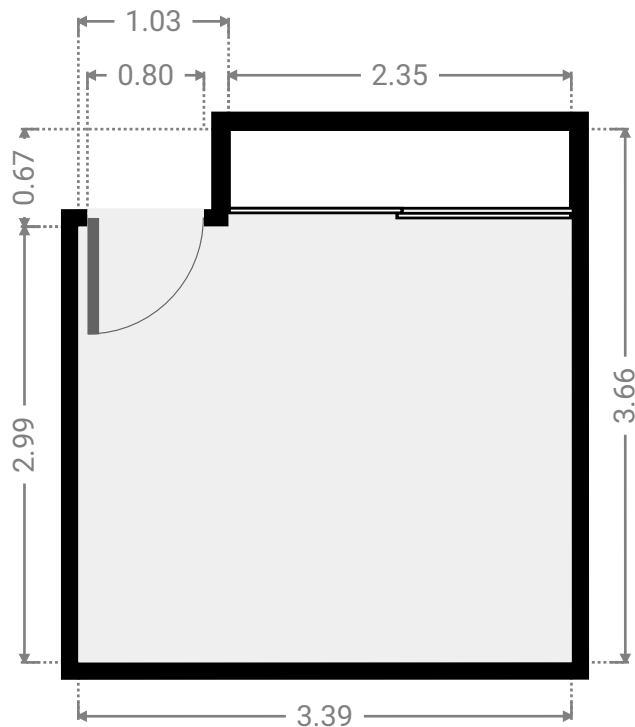

▼ Bedroom
1st Floor

WIDTH: 3.90 m • LENGTH: 3.97 m
AREA: 15.49 m² • PERIMETER: 15.74 m

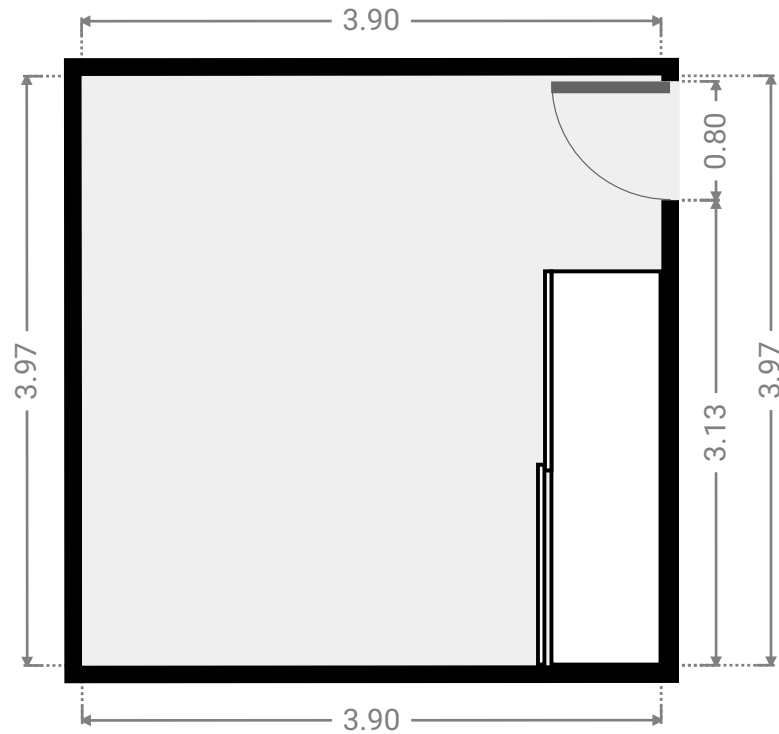

▼ Bedroom
1st Floor

WIDTH: 3.91 m • LENGTH: 3.00 m
AREA: 11.71 m² • PERIMETER: 13.81 m

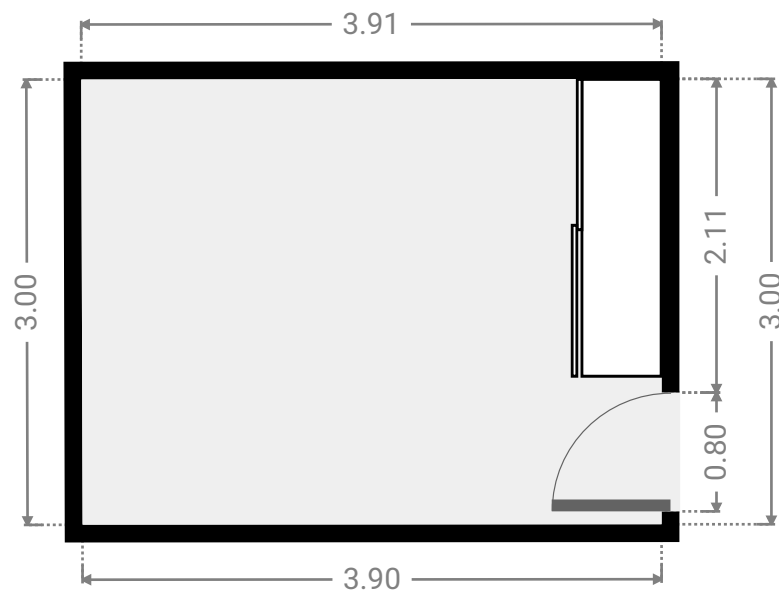
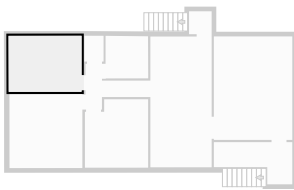

▼ Hall
1st Floor

WIDTH: 3.35 m • LENGTH: 2.45 m
AREA: 4.33 m² • PERIMETER: 11.61 m

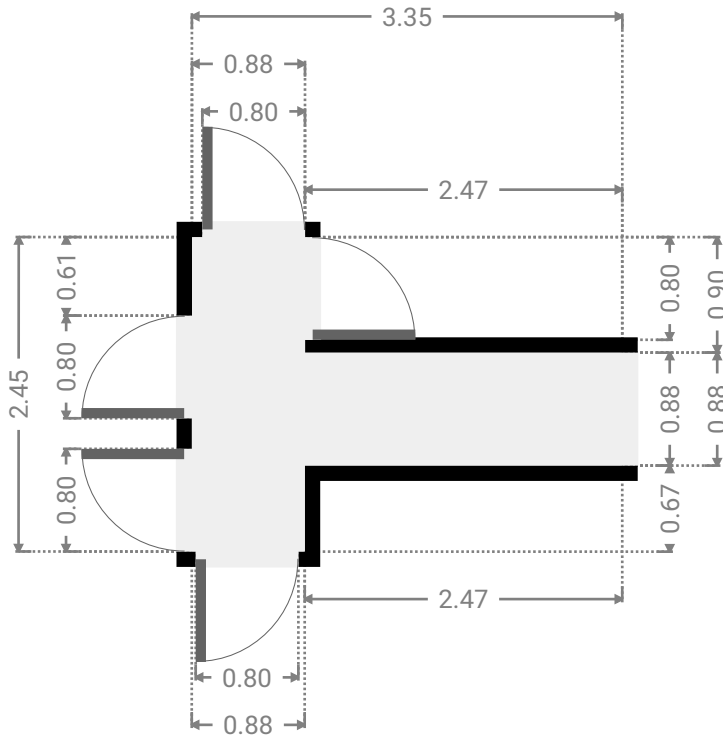
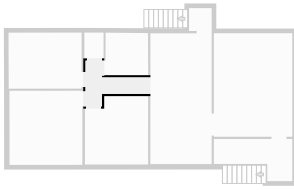

▼ Hallway
1st Floor

WIDTH: 1.21 m • LENGTH: 1.23 m
AREA: 1.48 m² • PERIMETER: 4.87 m

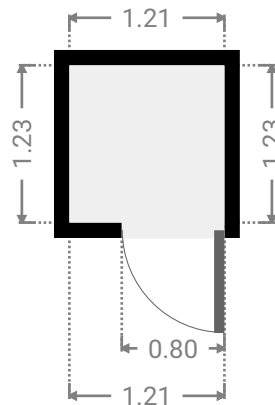
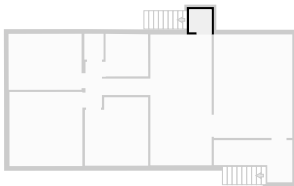

▼ **Kitchen**
1st Floor

WIDTH: 3.28 m • LENGTH: 7.00 m
AREA: 22.96 m² • PERIMETER: 20.56 m

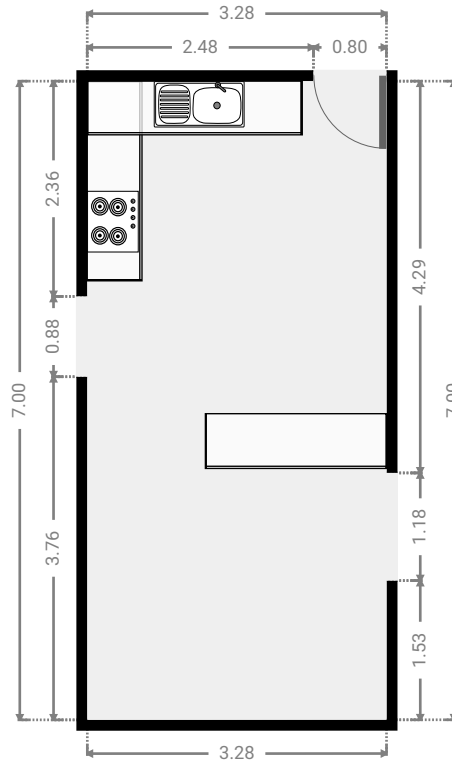
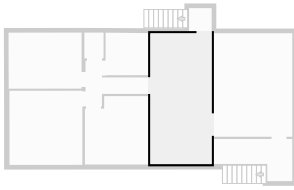

▼ **Living Room**
1st Floor

WIDTH: 4.20 m • LENGTH: 5.54 m
AREA: 23.27 m² • PERIMETER: 19.48 m

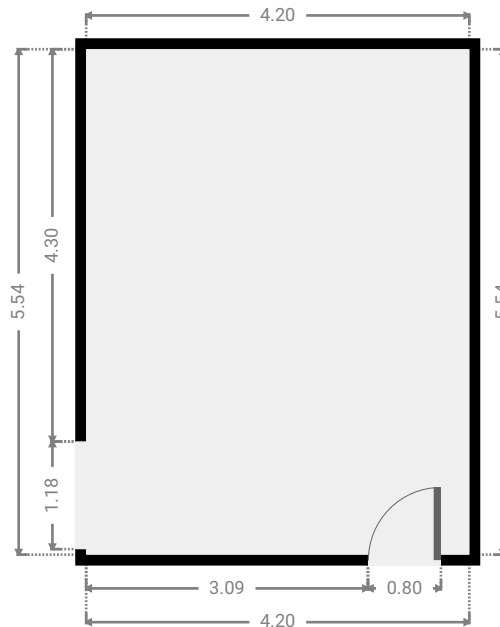
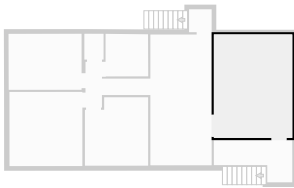

▼ **Other**
1st Floor

WIDTH: 4.20 m • LENGTH: 2.26 m
AREA: 6.85 m² • PERIMETER: 12.92 m

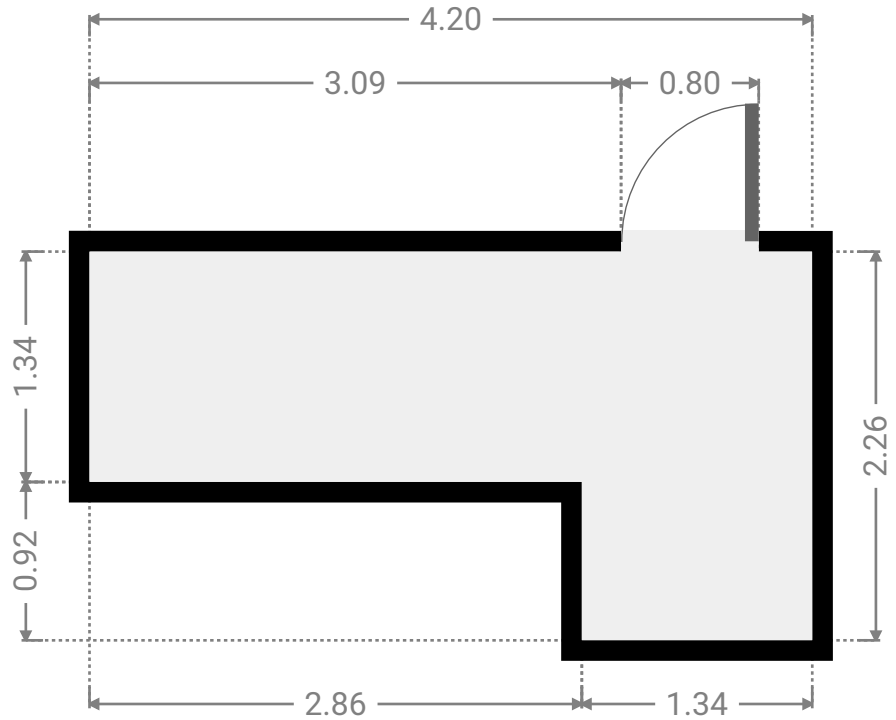

▼ **Toilet**
1st Floor

WIDTH: 1.03 m • LENGTH: 1.38 m
AREA: 1.42 m² • PERIMETER: 4.81 m

