

78 Murray Street

Ground Floor

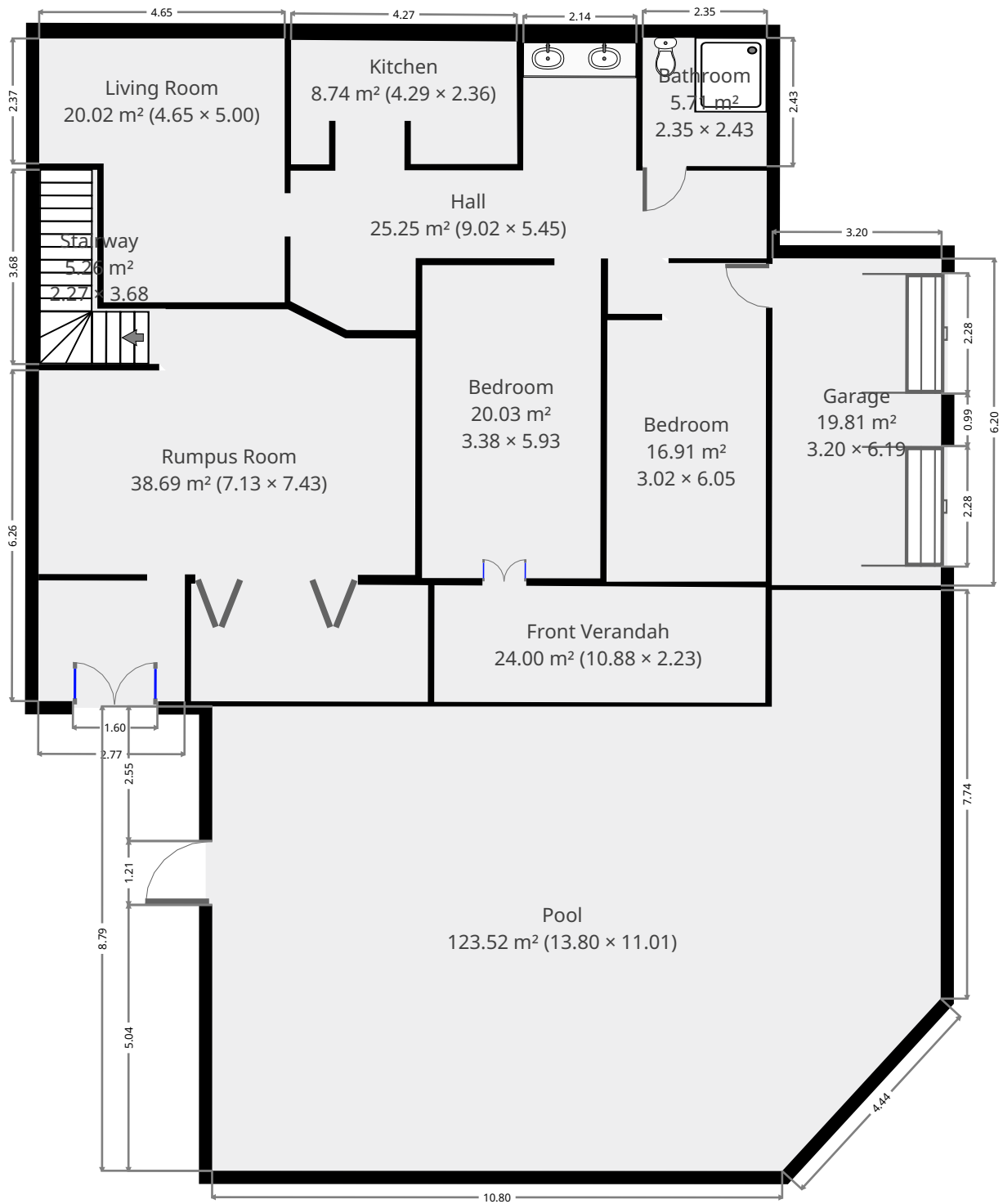

THIS FLOORPLAN IS PROVIDED WITHOUT WARRANTY OF ANY KIND. SENSOPIA DISCLAIMS ANY WARRANTY INCLUDING, WITHOUT LIMITATION, SATISFACTORY QUALITY OR ACCURACY OF DIMENSIONS.



78 Murray Street

Rumpus Room

Width: 7.13 m
 Length: 7.43 m
 Area: 38.69 m²
 Perimeter: 28.71 m

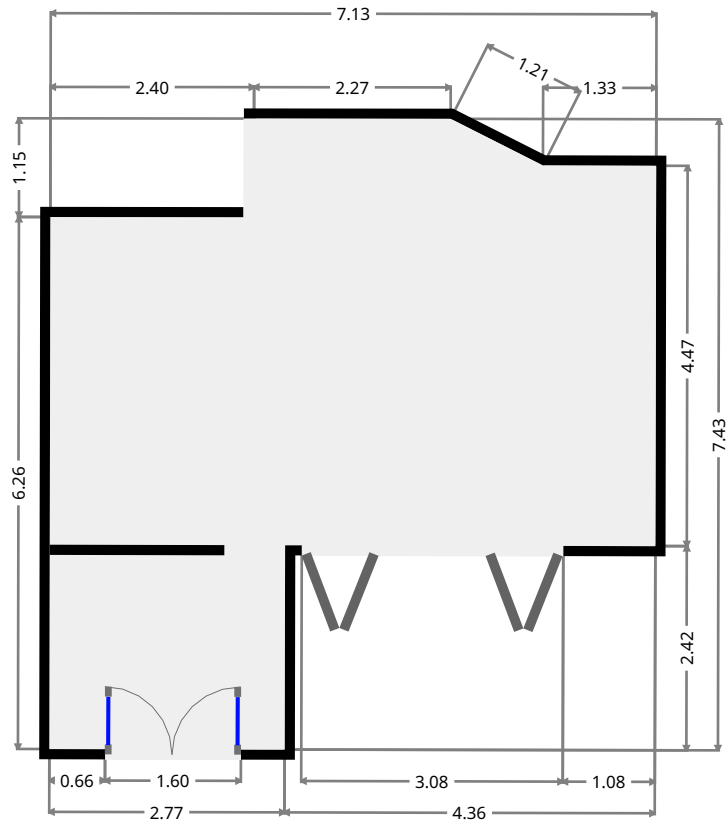
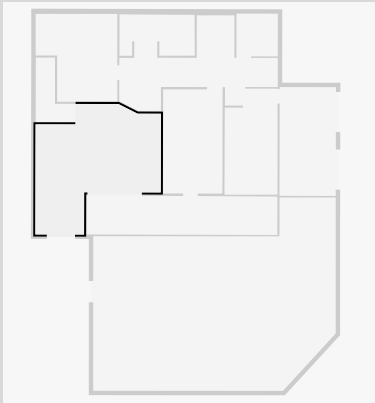

Hall

Width: 5.45 m
 Length: 9.02 m
 Area: 25.25 m²
 Perimeter: 32.24 m

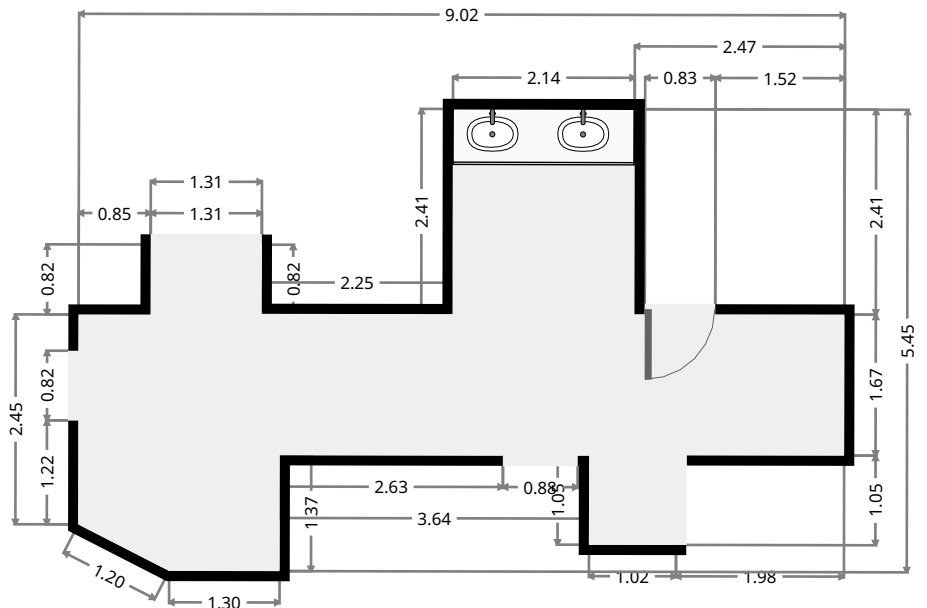
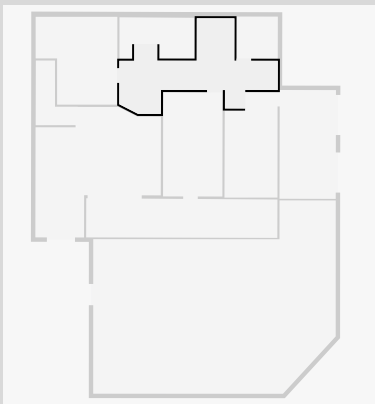

THIS FLOORPLAN IS PROVIDED WITHOUT WARRANTY OF ANY KIND. SENSOPIA DISCLAIMS ANY WARRANTY INCLUDING, WITHOUT LIMITATION, SATISFACTORY QUALITY OR ACCURACY OF DIMENSIONS.

78 Murray Street

Bathroom

Width: 2.35 m
Length: 2.43 m
Area: 5.71 m²
Perimeter: 9.56 m

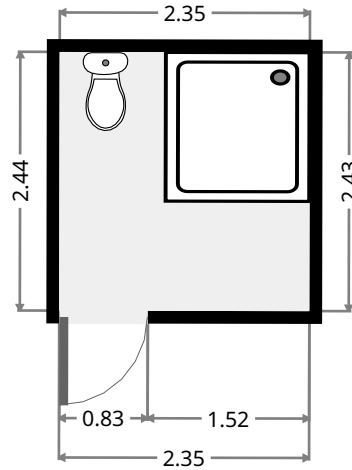
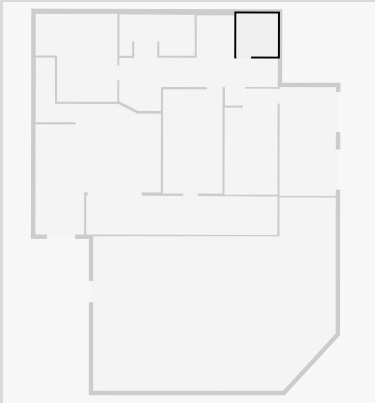

Bedroom

Width: 3.38 m
Length: 5.93 m
Area: 20.03 m²
Perimeter: 18.61 m

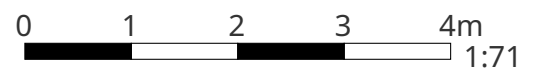
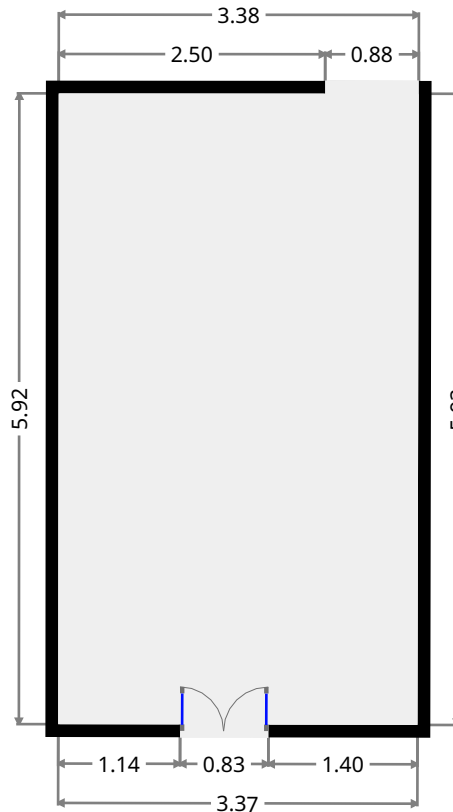
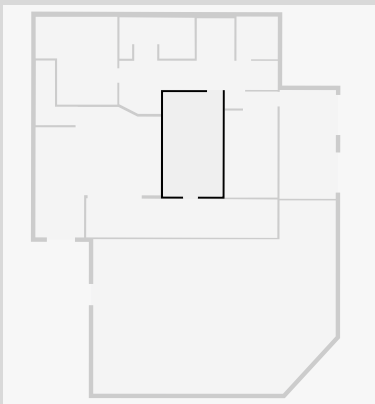

78 Murray Street

Bedroom

Width: 3.02 m
Length: 6.05 m
Area: 16.91 m²
Perimeter: 18.09 m

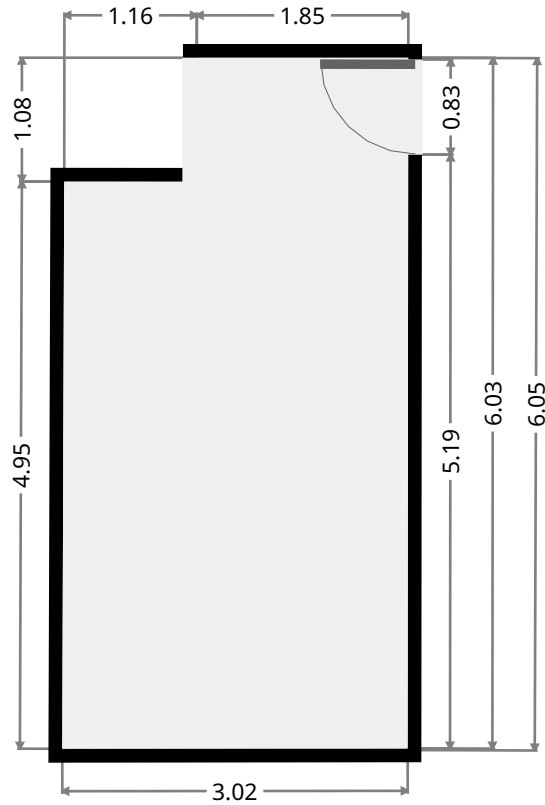
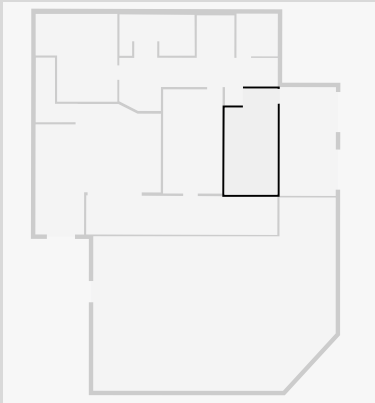

Living Room

Width: 4.65 m
Length: 5.00 m
Area: 20.02 m²
Perimeter: 19.29 m

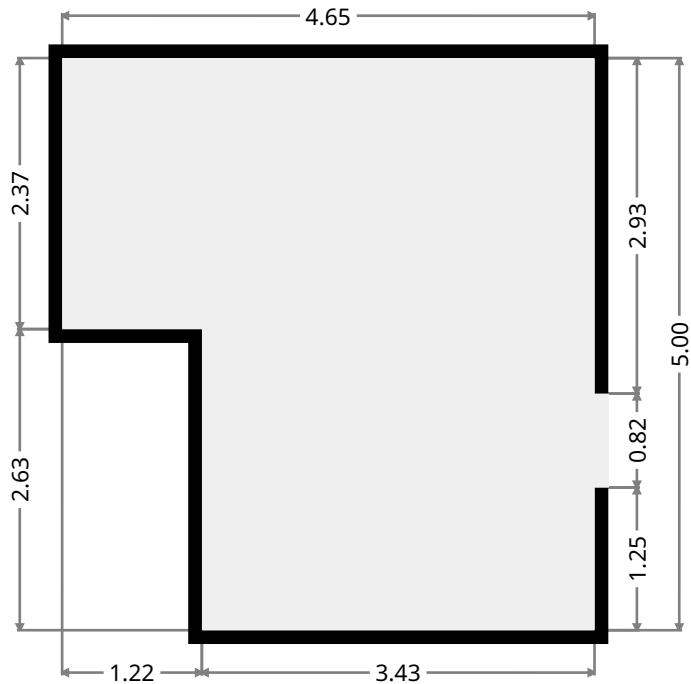
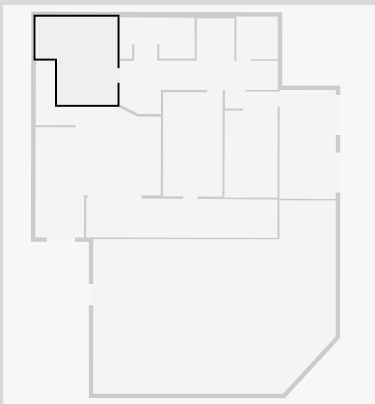

78 Murray Street

Kitchen

Width: 2.36 m
 Length: 4.29 m
 Area: 8.74 m²
 Perimeter: 14.88 m

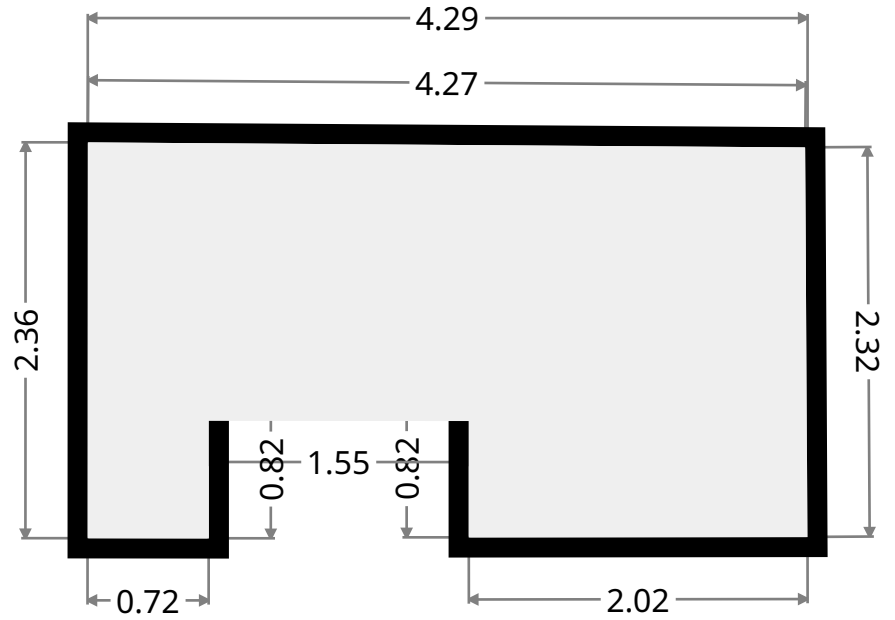
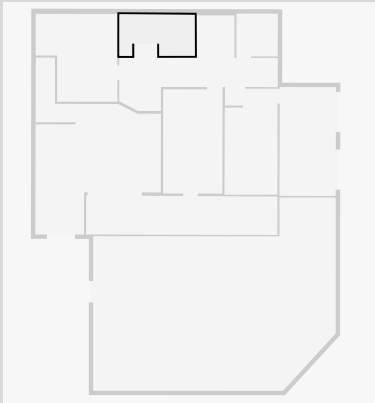

Stairway

Width: 2.27 m
 Length: 3.68 m
 Area: 5.26 m²
 Perimeter: 11.89 m

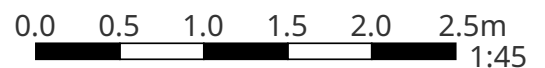
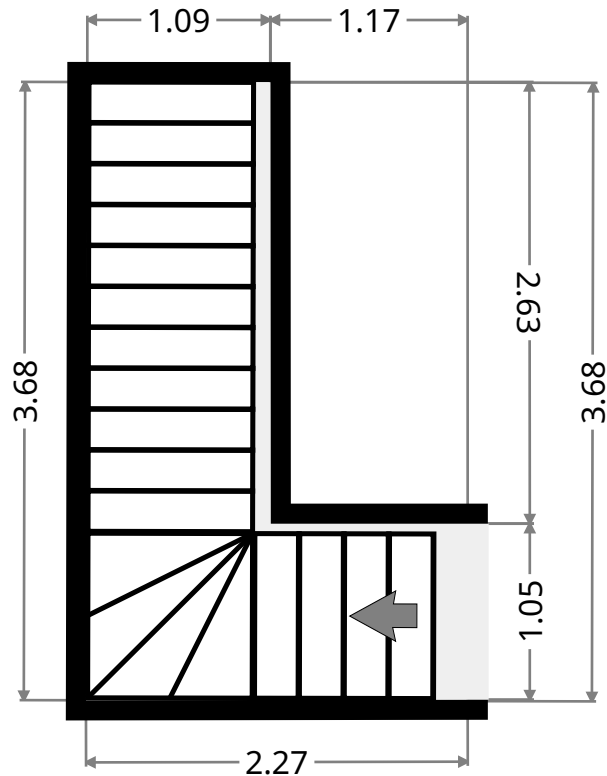
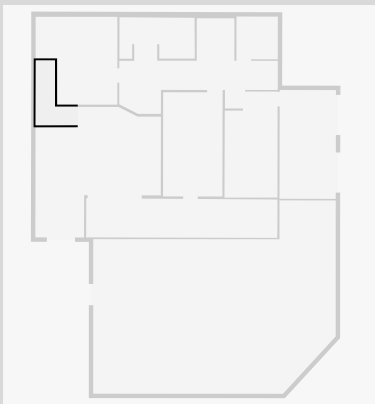

THIS FLOORPLAN IS PROVIDED WITHOUT WARRANTY OF ANY KIND. SENSOPIA DISCLAIMS ANY WARRANTY INCLUDING, WITHOUT LIMITATION, SATISFACTORY QUALITY OR ACCURACY OF DIMENSIONS.

78 Murray Street

Front Verandah

Width:	2.23 m
Length:	10.88 m
Area	24.00 m ²
Perimeter	26.17 m

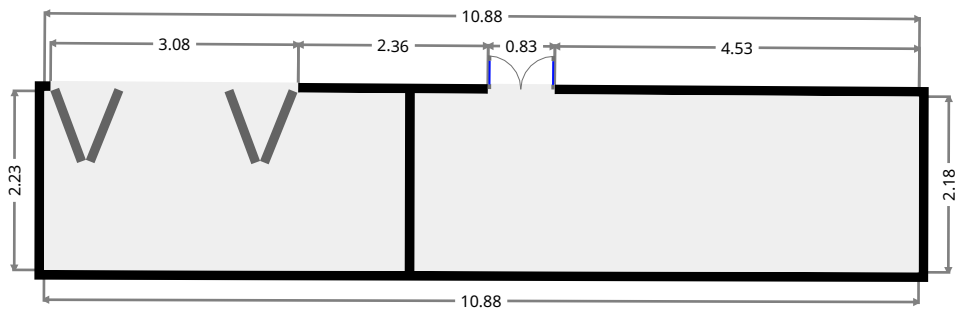
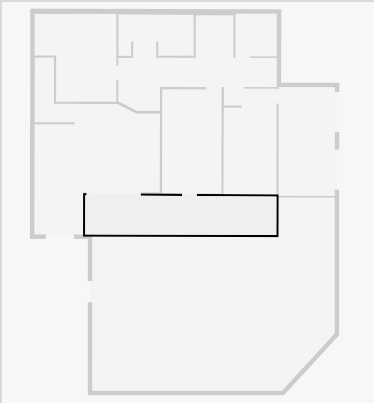

78 Murray Street

Pool

Width: 11.01 m
Length: 13.80 m
Area: 123.52 m²
Perimeter: 47.77 m

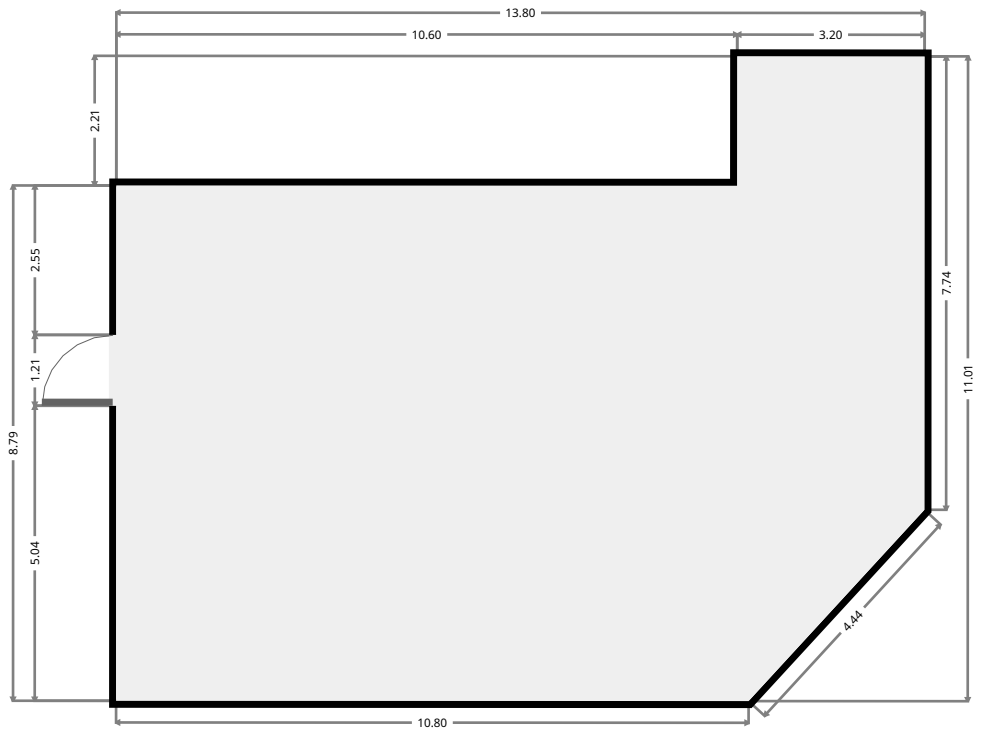
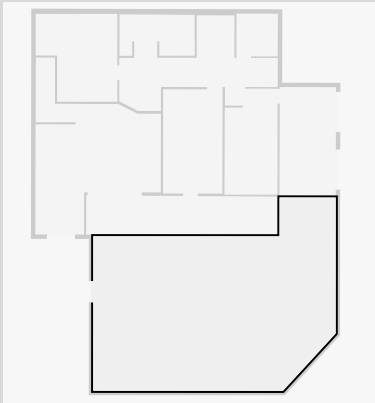

78 Murray Street

Garage

Width: 3.20 m
Length: 6.19 m
Area: 19.81 m²
Perimeter: 18.78 m

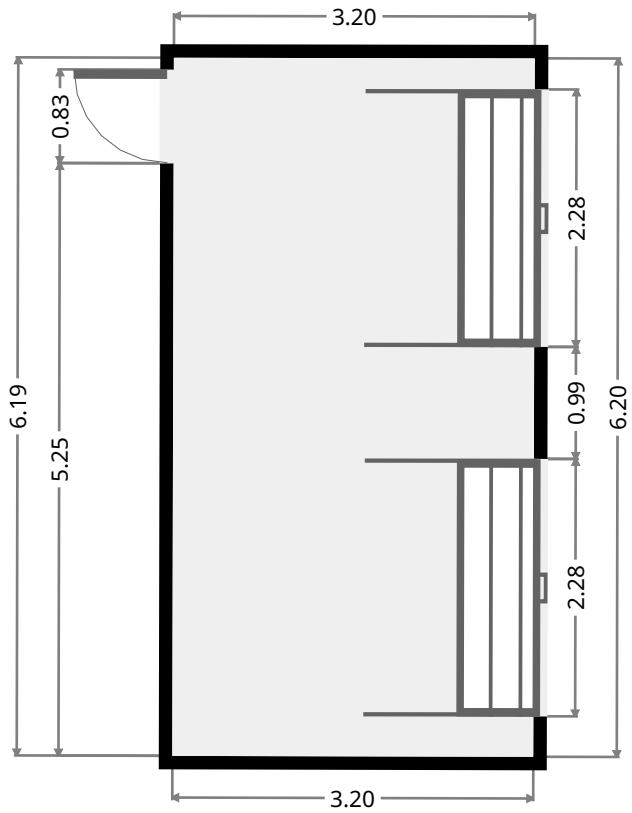
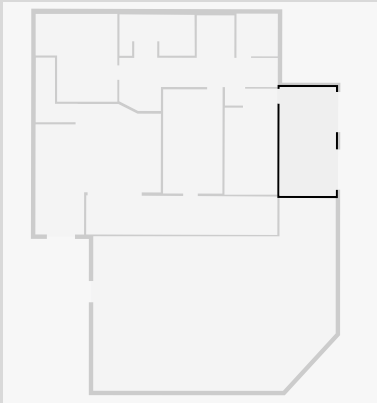

78 Murray Street

1st Floor

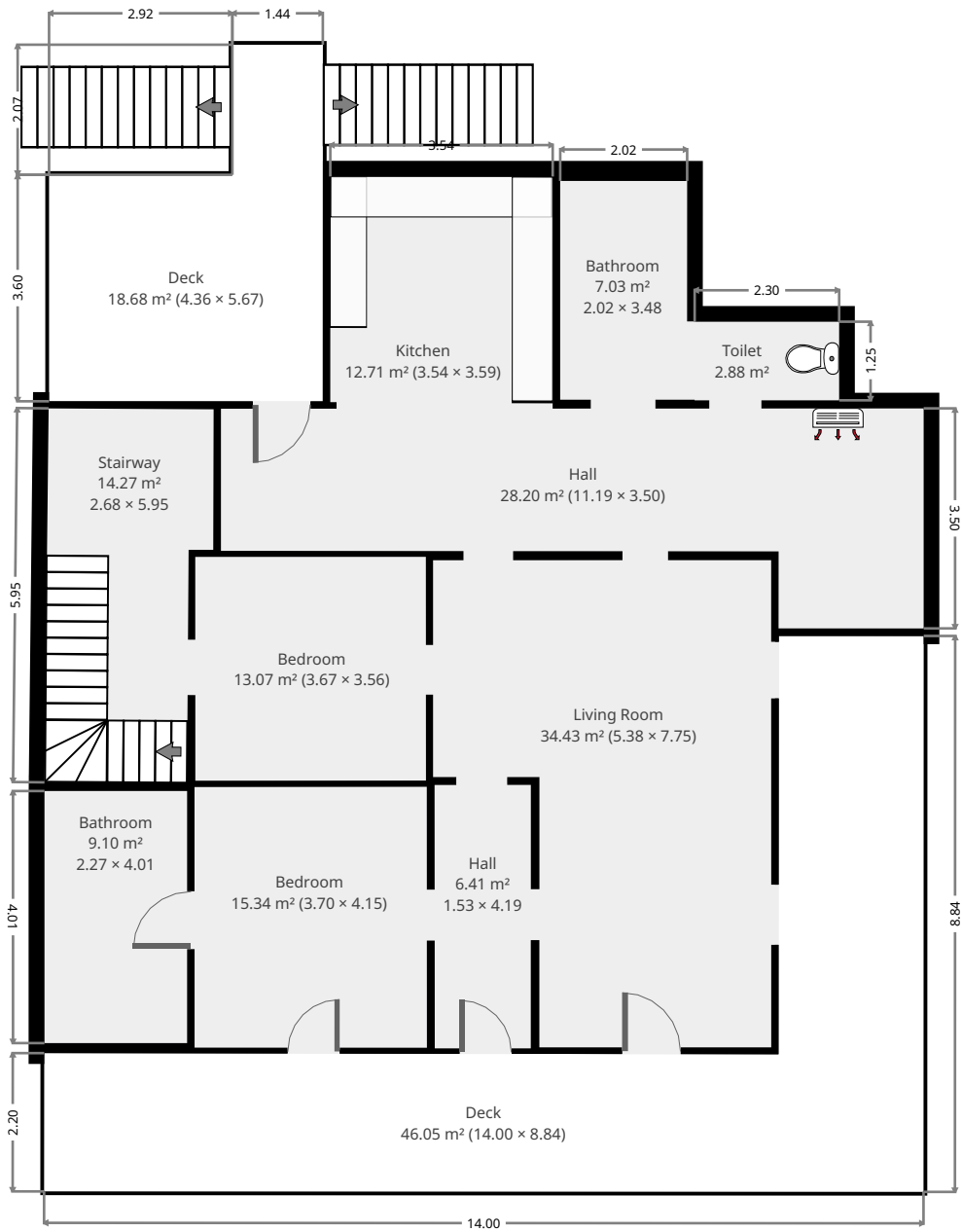

THIS FLOORPLAN IS PROVIDED WITHOUT WARRANTY OF ANY KIND. SENSOPIA DISCLAIMS ANY WARRANTY INCLUDING, WITHOUT LIMITATION, SATISFACTORY QUALITY OR ACCURACY OF DIMENSIONS.



78 Murray Street

Living Room

Width: 5.38 m
 Length: 7.75 m
 Area: 34.43 m²
 Perimeter: 26.27 m

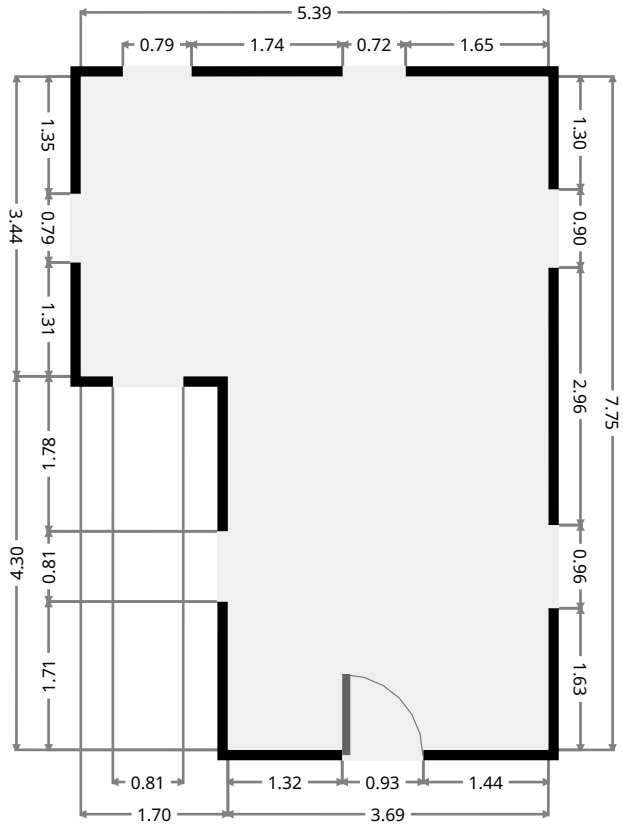
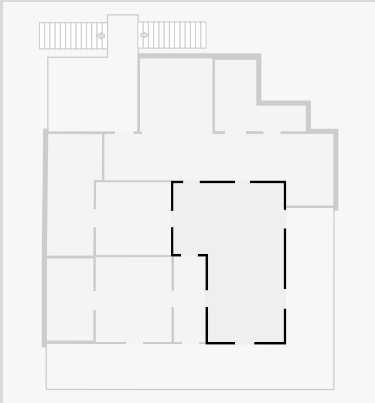

Hall

Width: 1.53 m
 Length: 4.19 m
 Area: 6.41 m²
 Perimeter: 11.44 m

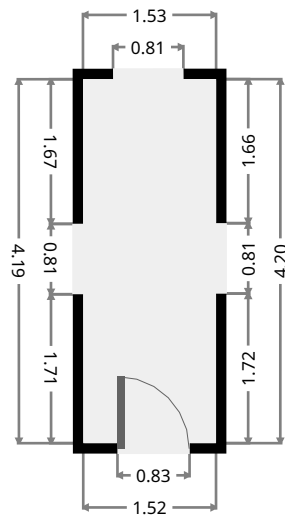
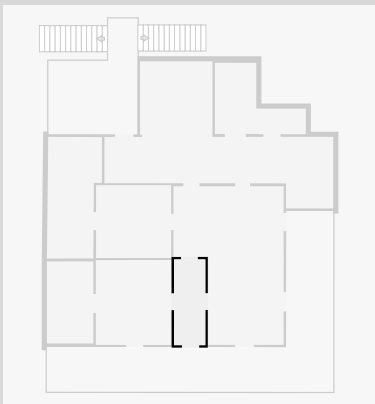

THIS FLOORPLAN IS PROVIDED WITHOUT WARRANTY OF ANY KIND. SENSOPIA DISCLAIMS ANY WARRANTY INCLUDING, WITHOUT LIMITATION, SATISFACTORY QUALITY OR ACCURACY OF DIMENSIONS.

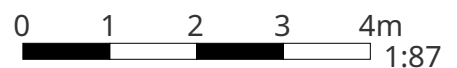

78 Murray Street

Bedroom

Width: 3.70 m
 Length: 4.15 m
 Area: 15.34 m²
 Perimeter: 15.69 m

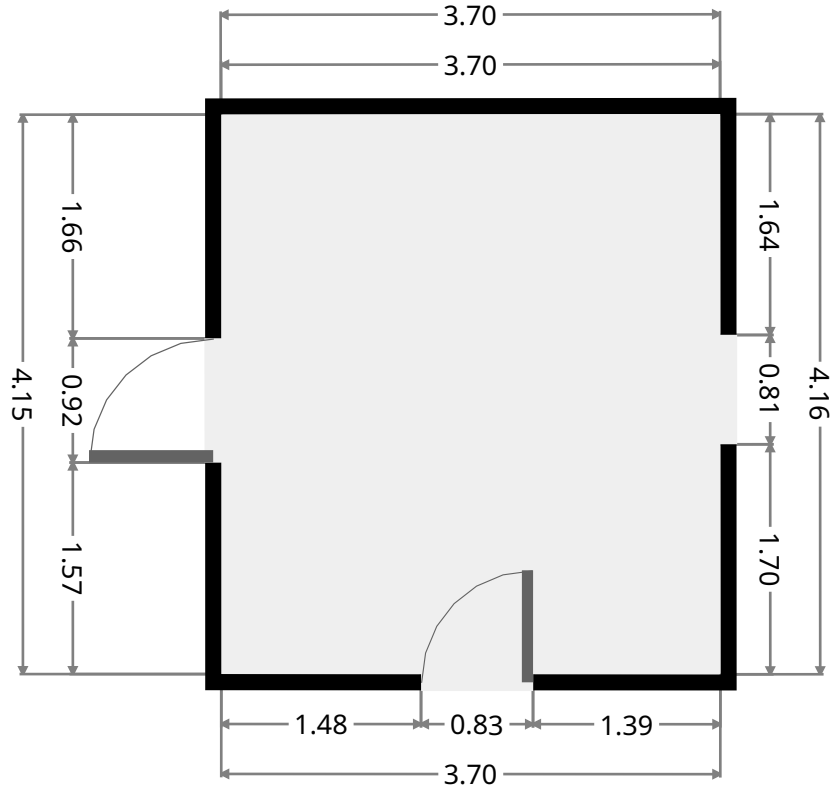
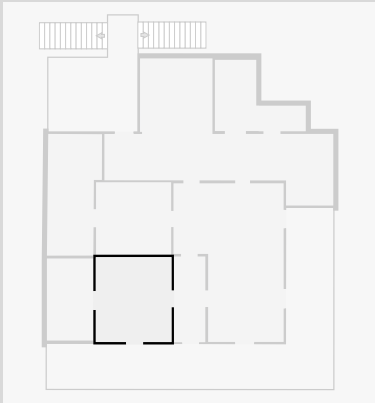

Bathroom

Width: 2.27 m
 Length: 4.01 m
 Area: 9.10 m²
 Perimeter: 12.56 m

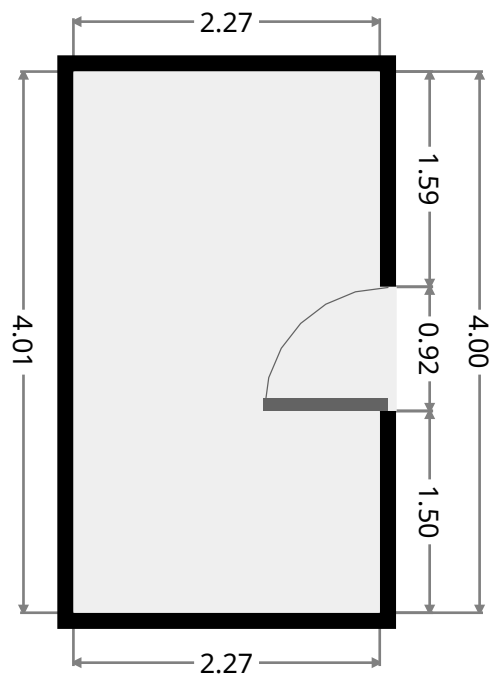
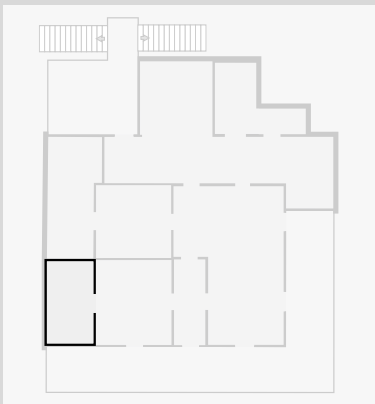

78 Murray Street

Bedroom

Width: 3.56 m
 Length: 3.67 m
 Area: 13.07 m²
 Perimeter: 14.46 m

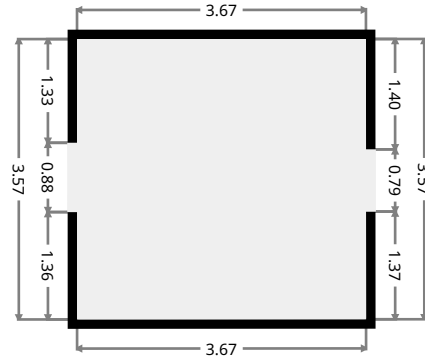
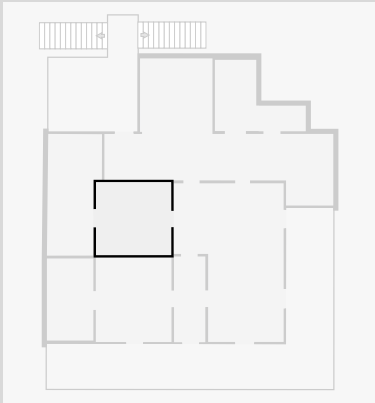

Hall

Width: 3.50 m
 Length: 11.19 m
 Area: 28.20 m²
 Perimeter: 29.36 m

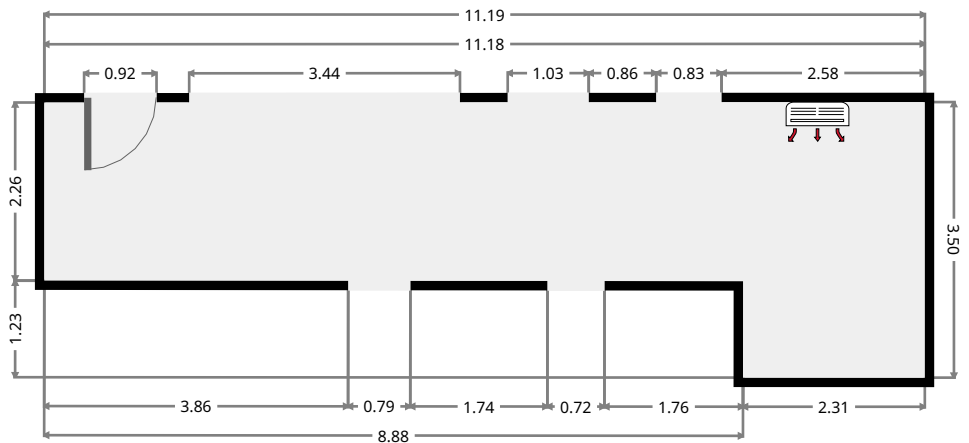
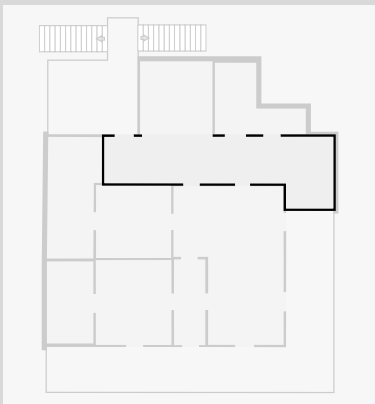

THIS FLOORPLAN IS PROVIDED WITHOUT WARRANTY OF ANY KIND. SENSOPIA DISCLAIMS ANY WARRANTY INCLUDING, WITHOUT LIMITATION, SATISFACTORY QUALITY OR ACCURACY OF DIMENSIONS.



78 Murray Street

Toilet / Half Bath

Width: 1.25 m
 Length: 2.30 m
 Area: 2.88 m²
 Perimeter: 7.10 m

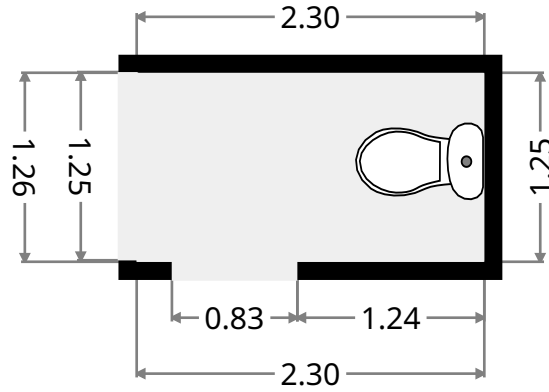
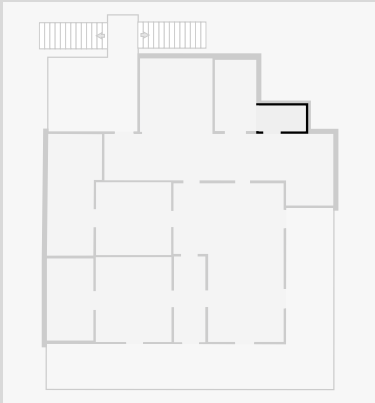

Bathroom

Width: 2.02 m
 Length: 3.48 m
 Area: 7.03 m²
 Perimeter: 11.00 m

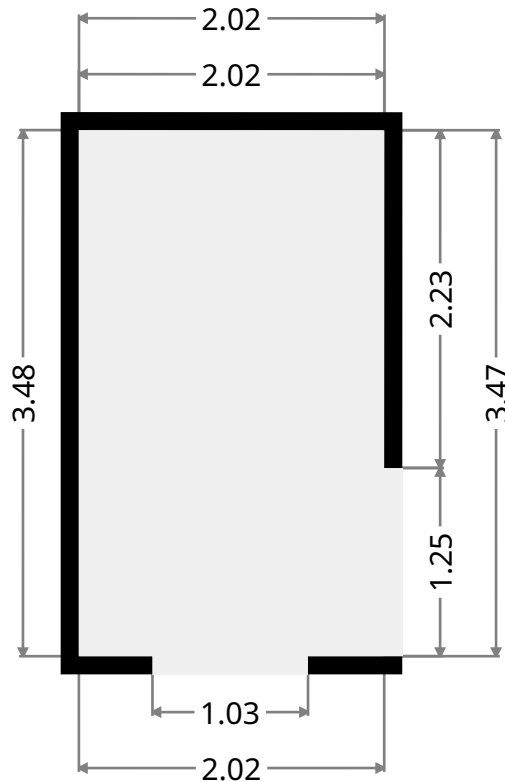
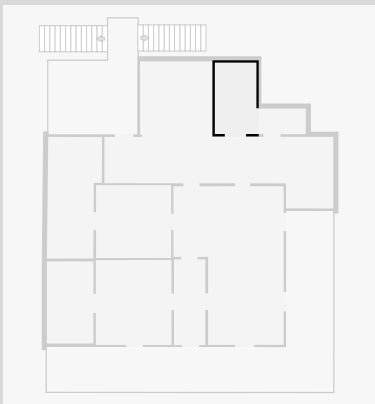

78 Murray Street

Kitchen

Width: 3.54 m
Length: 3.59 m
Area: 12.71 m²
Perimeter: 14.26 m

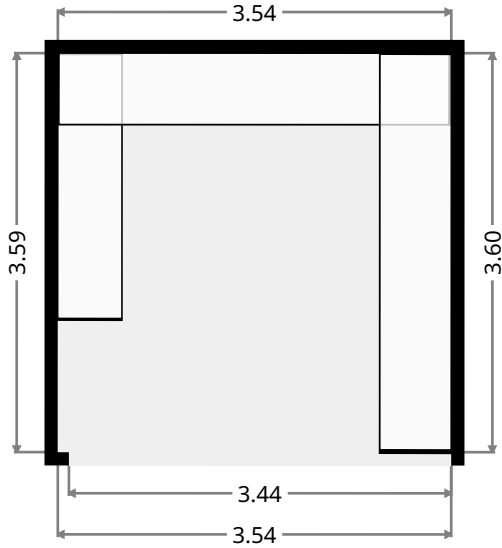
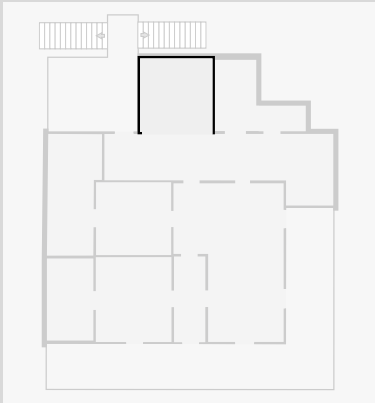

Stairway

Width: 2.68 m
Length: 5.95 m
Area: 14.27 m²
Perimeter: 17.17 m

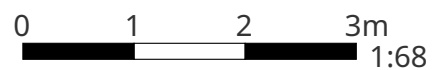
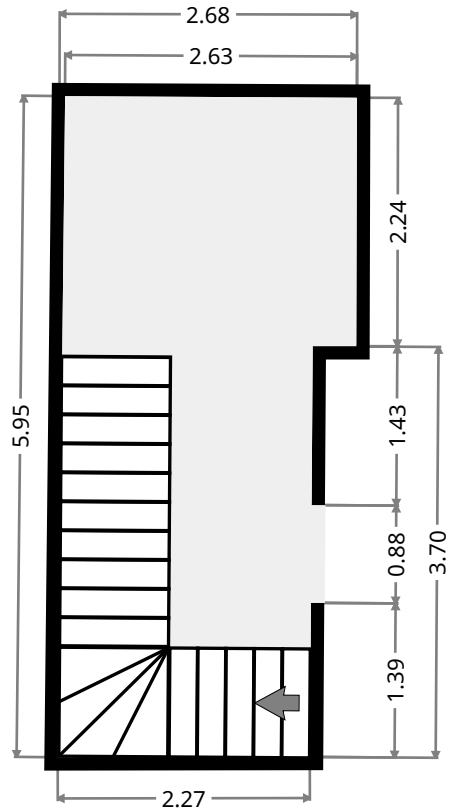
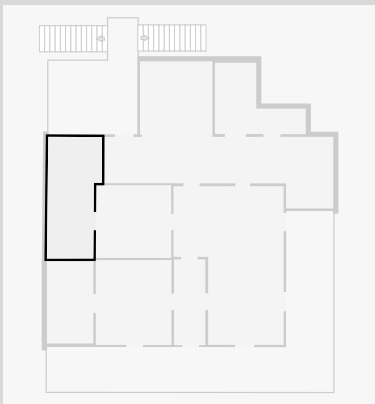

THIS FLOORPLAN IS PROVIDED WITHOUT WARRANTY OF ANY KIND. SENSOPIA DISCLAIMS ANY WARRANTY INCLUDING, WITHOUT LIMITATION, SATISFACTORY QUALITY OR ACCURACY OF DIMENSIONS.

78 Murray Street

Deck

Width: 4.36 m
 Length: 5.67 m
 Area: 18.68 m²
 Perimeter: 20.06 m

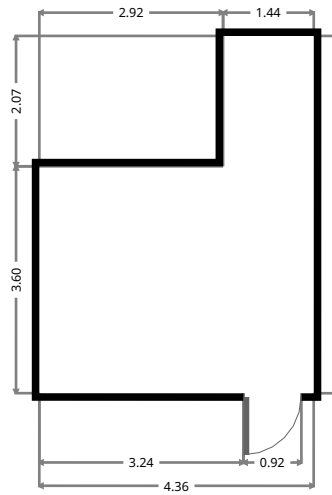
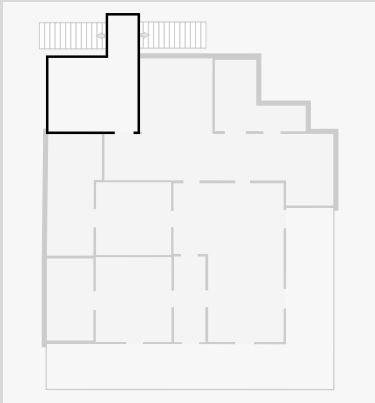

Deck

Width: 8.84 m
 Length: 14.00 m
 Area: 46.05 m²
 Perimeter: 45.69 m

