

75 Talford Street

Created on
2021-01-11

Floors 1

▼ Ground Floor

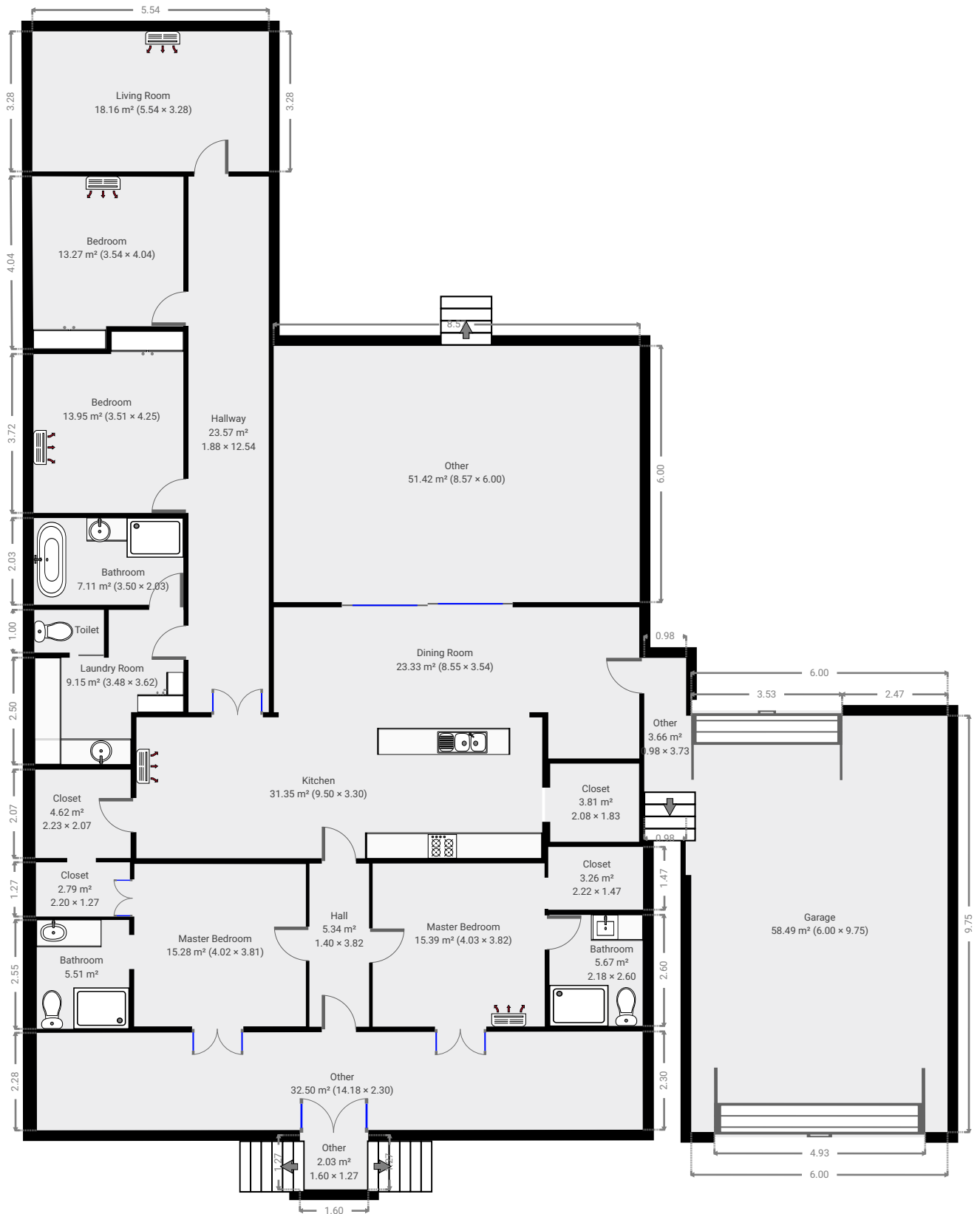

▼ Other
Ground Floor

WIDTH:8.57 m · LENGTH:6.00 m
AREA:51.42 m² · PERIMETER:29.14 m

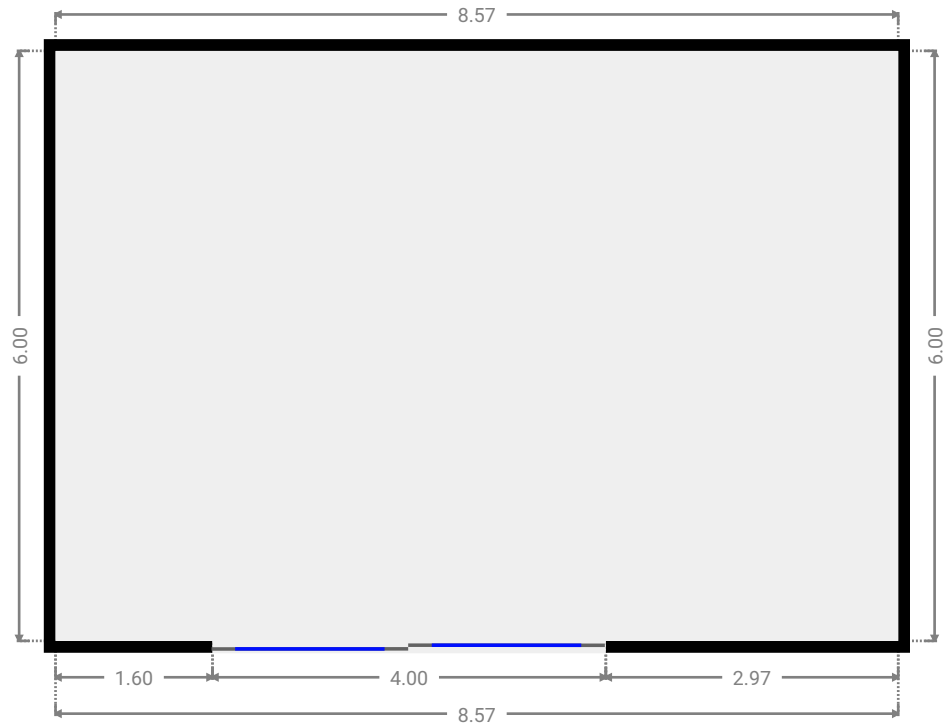
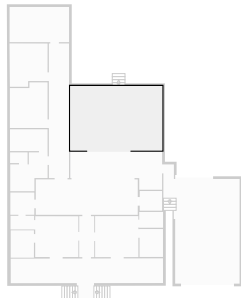

▼ Other
Ground Floor

WIDTH:1.60 m · LENGTH:1.27 m
AREA:2.03 m² · PERIMETER:5.74 m

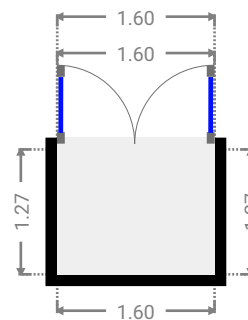

▼ **Other**
Ground Floor

WIDTH:14.18 m · LENGTH:2.30 m
AREA:32.50 m² · PERIMETER:32.95 m

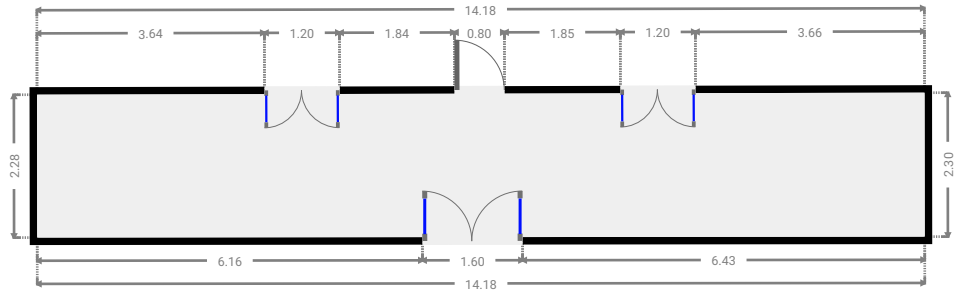
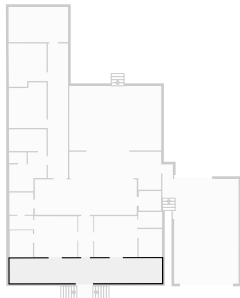

▼ **Garage**
Ground Floor

WIDTH:6.00 m · LENGTH:9.75 m
AREA:58.49 m² · PERIMETER:31.50 m

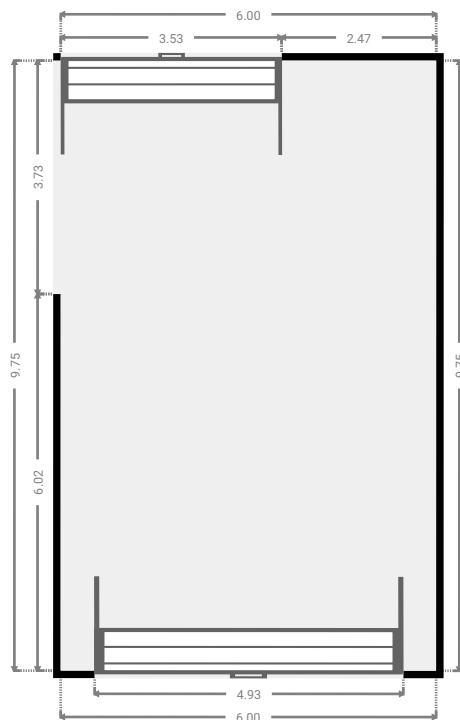
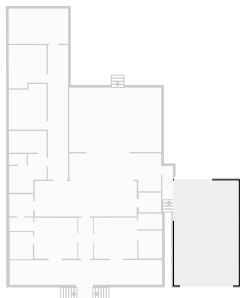

▼ **Other**
Ground Floor

WIDTH:0.98 m · LENGTH:3.73 m
AREA:3.66 m² · PERIMETER:9.42 m

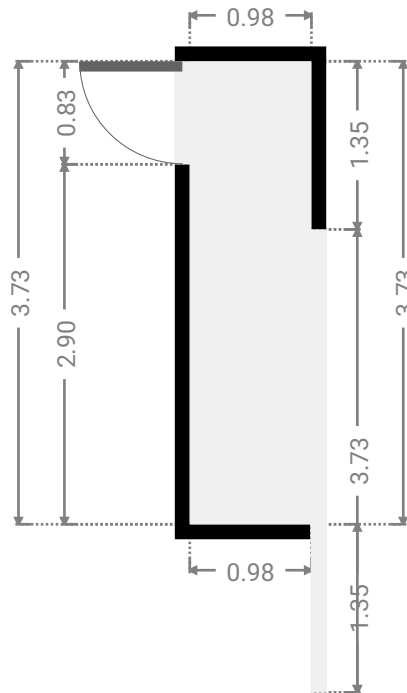
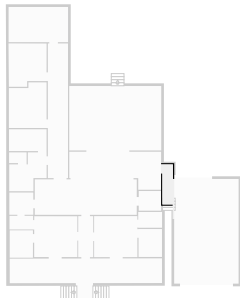

▼ **Living Room**
Ground Floor

WIDTH:5.54 m · LENGTH:3.28 m
AREA:18.16 m² · PERIMETER:17.64 m

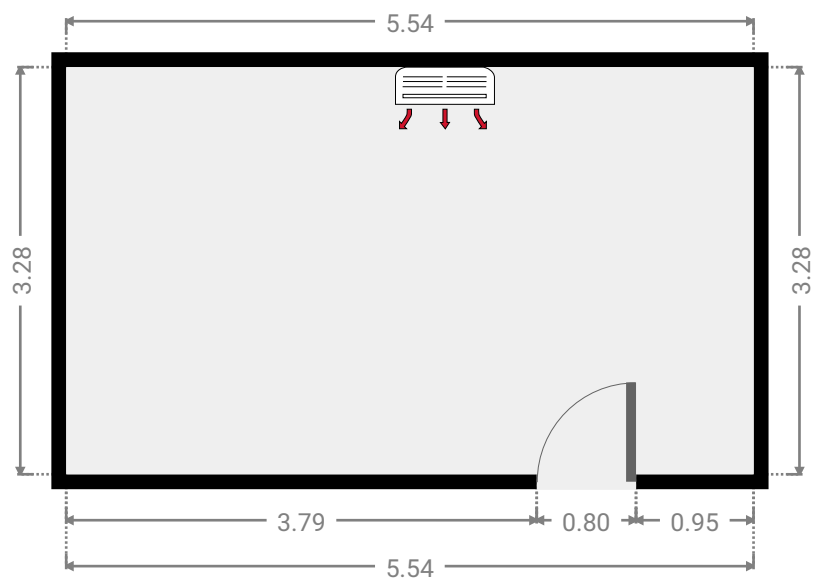
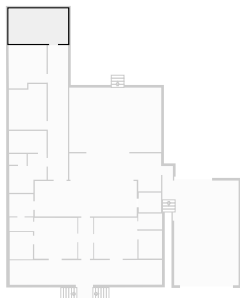

▼ **Bedroom**
Ground Floor

WIDTH:3.54 m · LENGTH:4.04 m
AREA:13.27 m² · PERIMETER:15.12 m

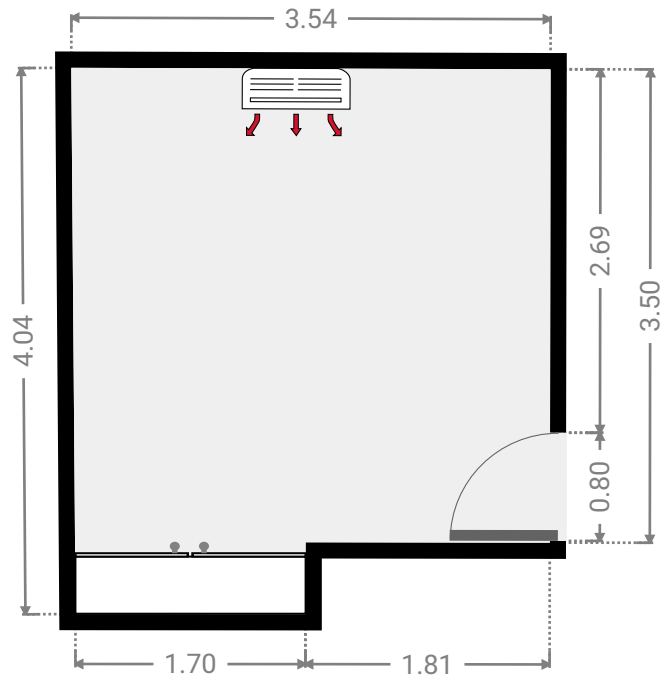
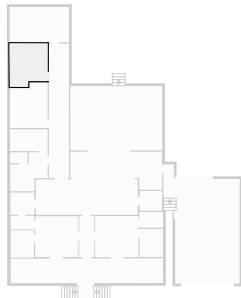

▼ **Bedroom**
Ground Floor

WIDTH:3.51 m · LENGTH:4.25 m
AREA:13.95 m² · PERIMETER:15.52 m

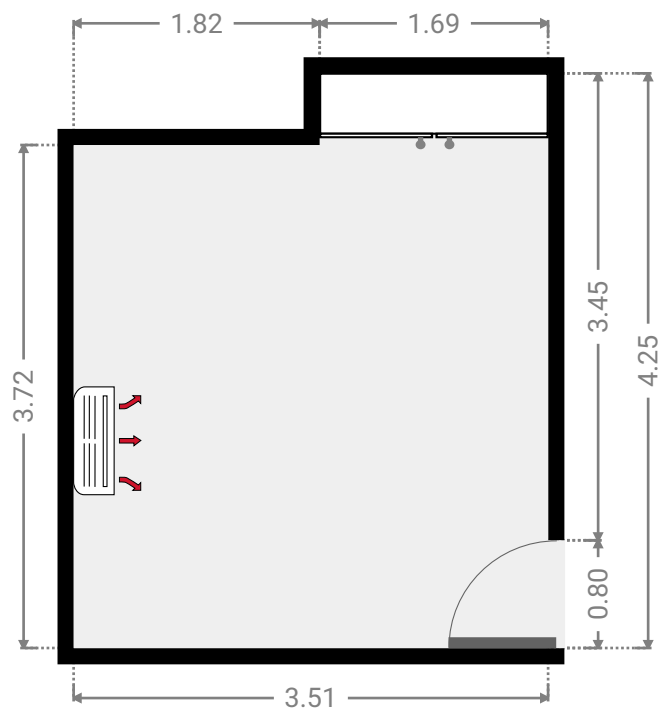
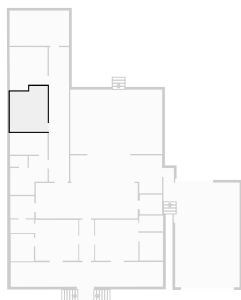

▼ **Bathroom**
Ground Floor

WIDTH:3.50 m · LENGTH:2.03 m
AREA:7.11 m² · PERIMETER:11.06 m

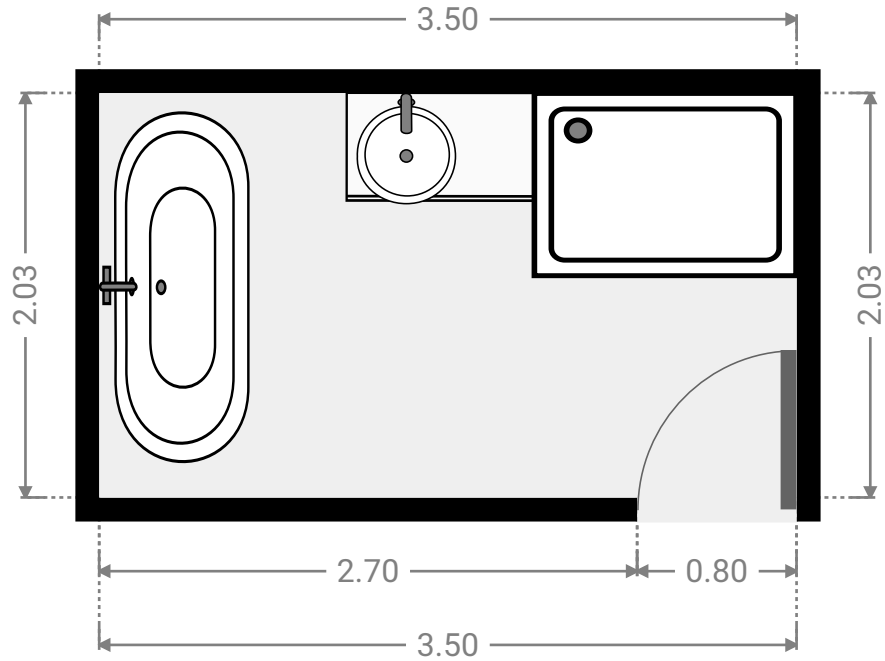
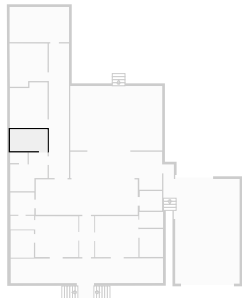

▼ **Toilet**
Ground Floor

WIDTH:1.63 m · LENGTH:1.00 m
AREA:1.63 m² · PERIMETER:5.26 m

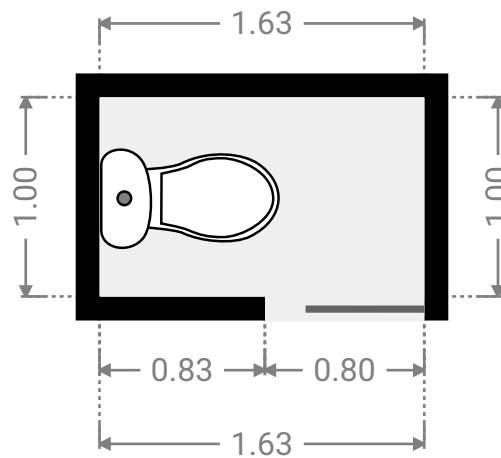
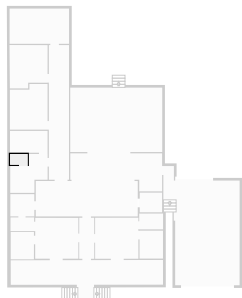

▼ Laundry Room
Ground Floor

WIDTH:3.48 m · LENGTH:3.62 m
AREA:9.15 m² · PERIMETER:14.20 m

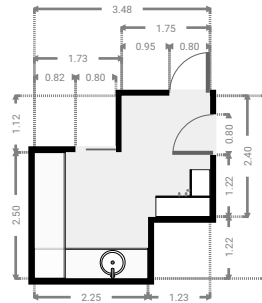
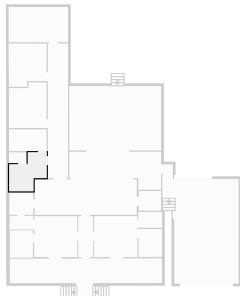

▼ Hallway
Ground Floor

WIDTH:1.88 m · LENGTH:12.54 m
AREA:23.57 m² · PERIMETER:28.84 m

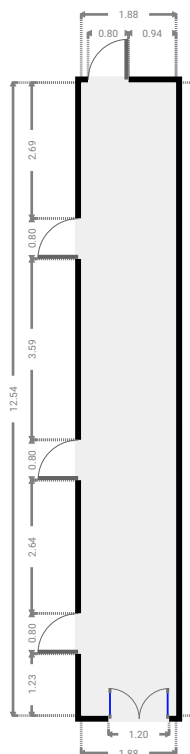
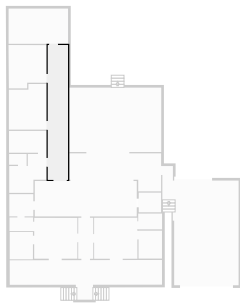

▼ **Hall**
Ground Floor

WIDTH:1.40 m · LENGTH:3.82 m
AREA:5.34 m² · PERIMETER:10.44 m

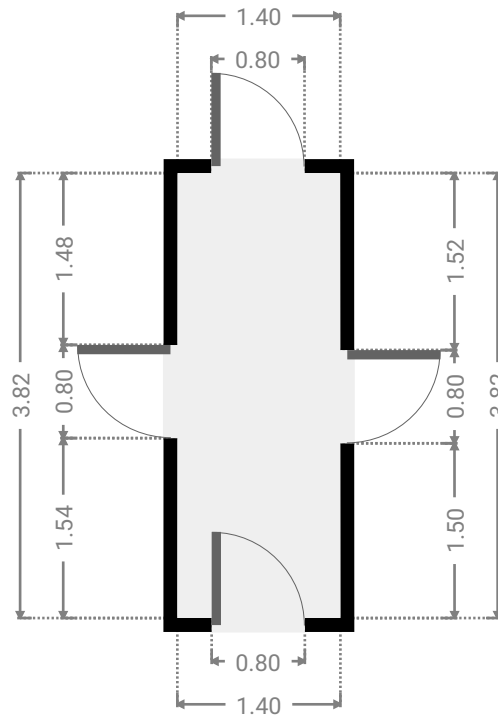
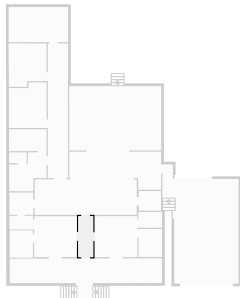

▼ **Closet**
Ground Floor

WIDTH:2.08 m · LENGTH:1.83 m
AREA:3.81 m² · PERIMETER:7.82 m

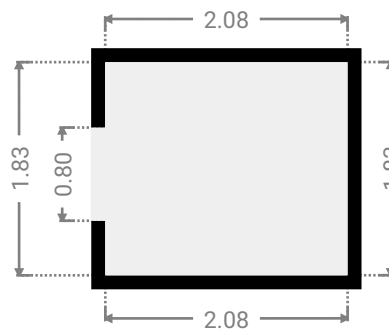
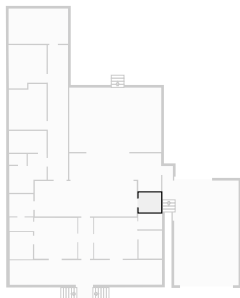

▼ Dining Room
Ground Floor

WIDTH:8.55 m · LENGTH:3.54 m
AREA:23.33 m² · PERIMETER:24.19 m

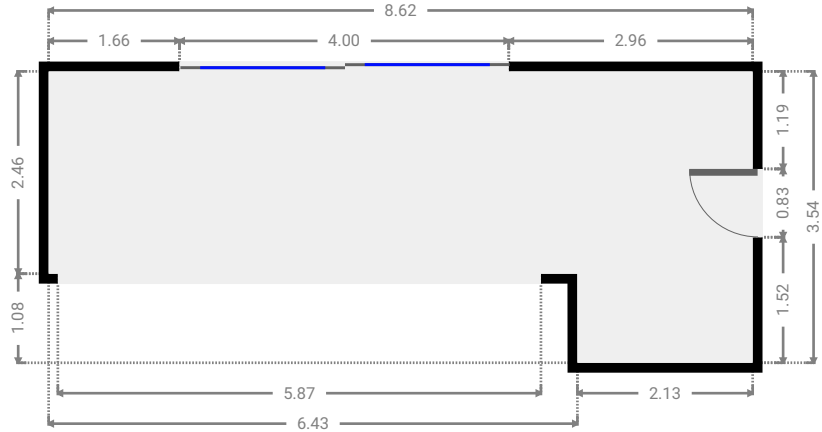
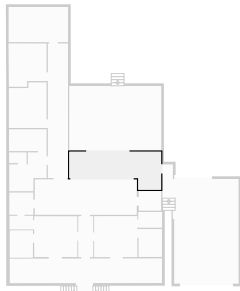

▼ Kitchen
Ground Floor

WIDTH:9.50 m · LENGTH:3.30 m
AREA:31.35 m² · PERIMETER:25.60 m

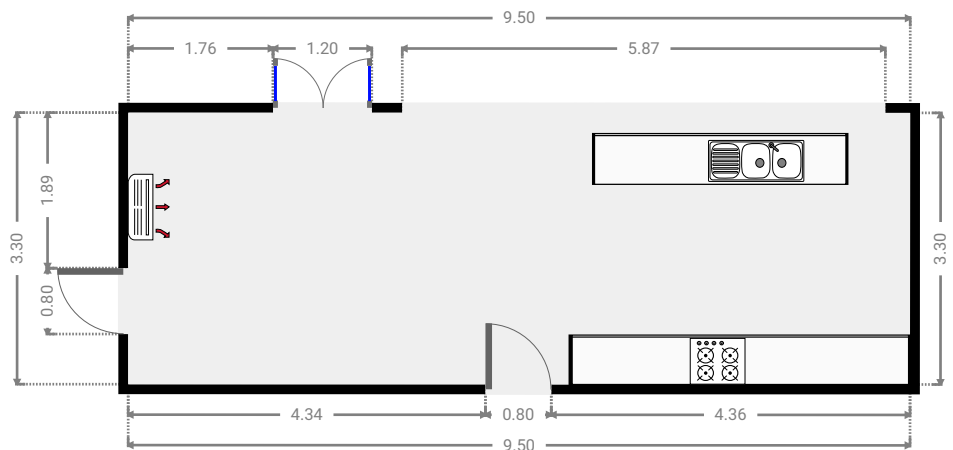
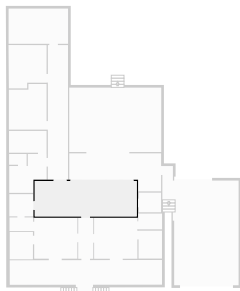

▼ Closet
Ground Floor

WIDTH:2.23 m · LENGTH:2.07 m
AREA:4.62 m² · PERIMETER:8.60 m

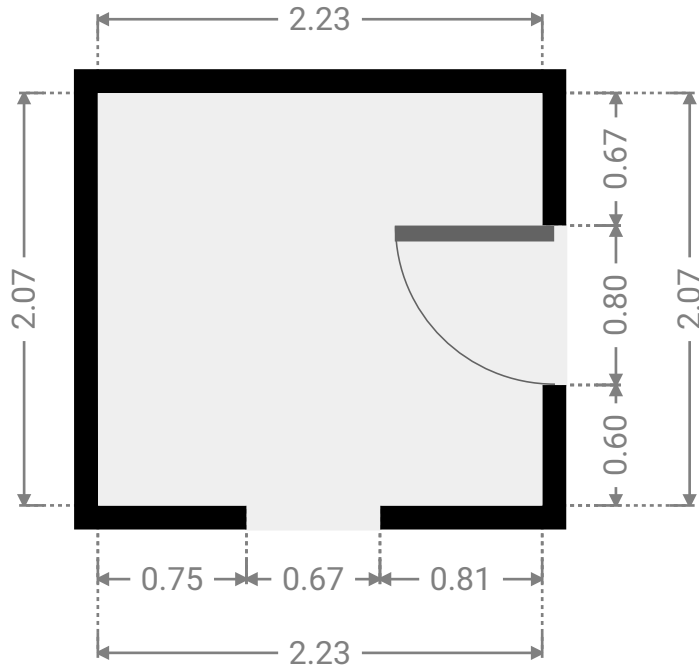
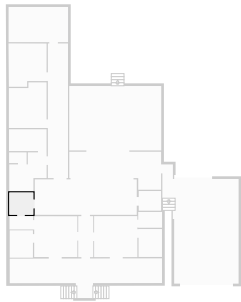

▼ Closet
Ground Floor

WIDTH:2.20 m · LENGTH:1.27 m
AREA:2.79 m² · PERIMETER:6.94 m

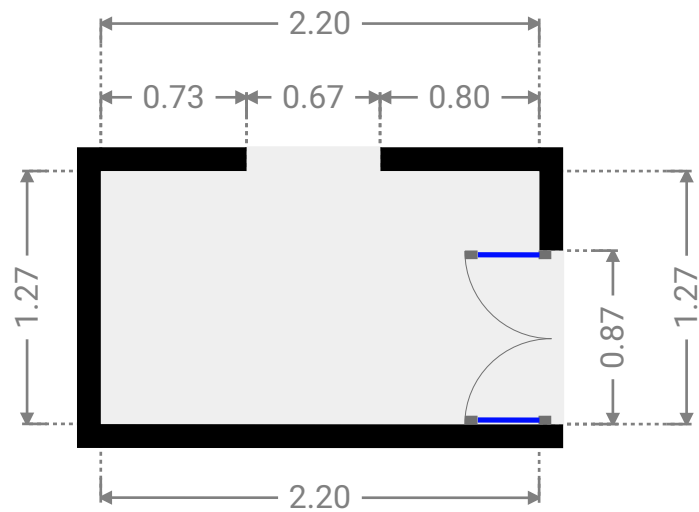
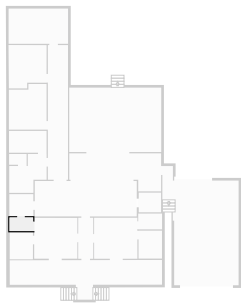

▼ Bathroom
Ground Floor

WIDTH:2.16 m · LENGTH:2.55 m
AREA:5.51 m² · PERIMETER:9.42 m

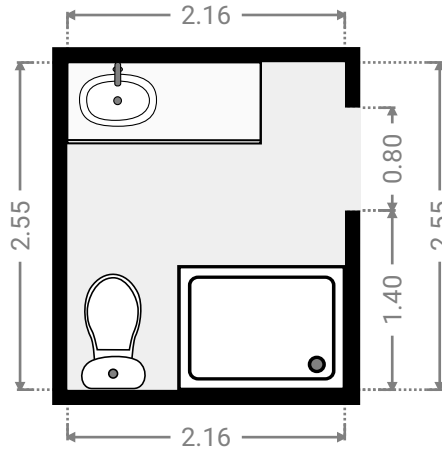
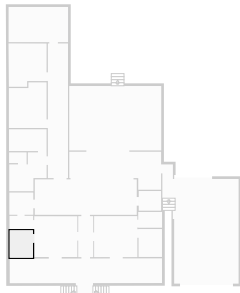

▼ Master Bedroom
Ground Floor

WIDTH:4.02 m · LENGTH:3.81 m
AREA:15.28 m² · PERIMETER:15.64 m

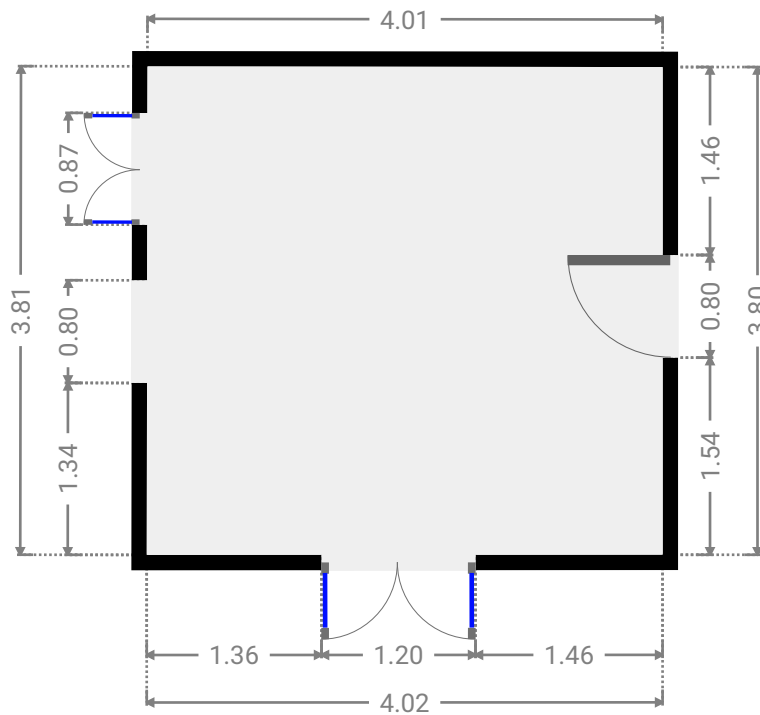
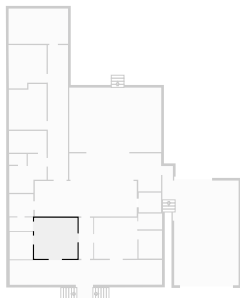

▼ **Closet**
Ground Floor

WIDTH:2.22 m · LENGTH:1.47 m
AREA:3.26 m² · PERIMETER:7.38 m

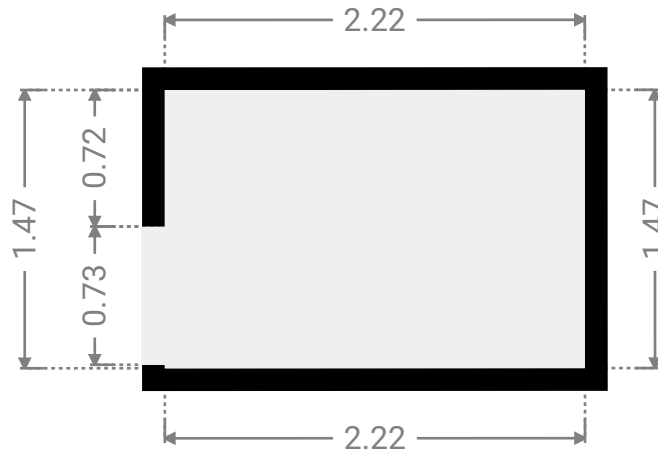
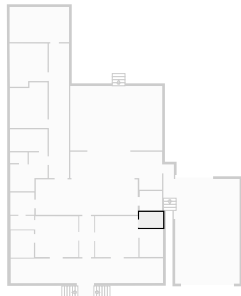

▼ **Bathroom**
Ground Floor

WIDTH:2.18 m · LENGTH:2.60 m
AREA:5.67 m² · PERIMETER:9.56 m

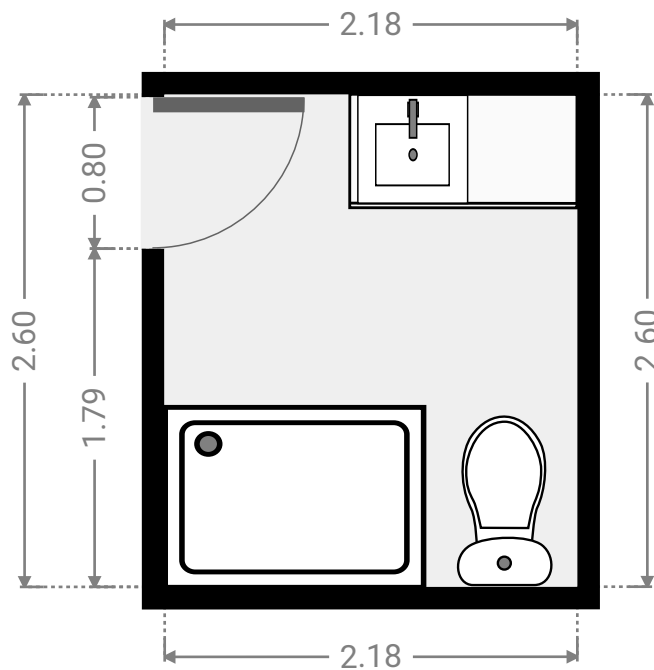
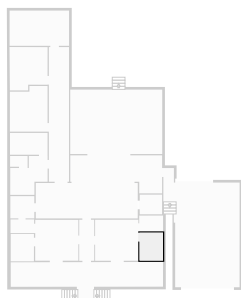

▼ Master Bedroom
Ground Floor

WIDTH:4.03 m · LENGTH:3.82 m
AREA:15.39 m² · PERIMETER:15.70 m

