

75 KINGFISHER PARADE

SUBMITTED BY
Ray White Rockhampton Casey
stockers@cqoz.com

CREATED ON
2022-07-12

Floors
1

FLOORS: 1

▼ **Bathroom**
Ground Floor

WIDTH: 1.67 m • LENGTH: 3.16 m
AREA: 5.10 m² • PERIMETER: 9.52 m

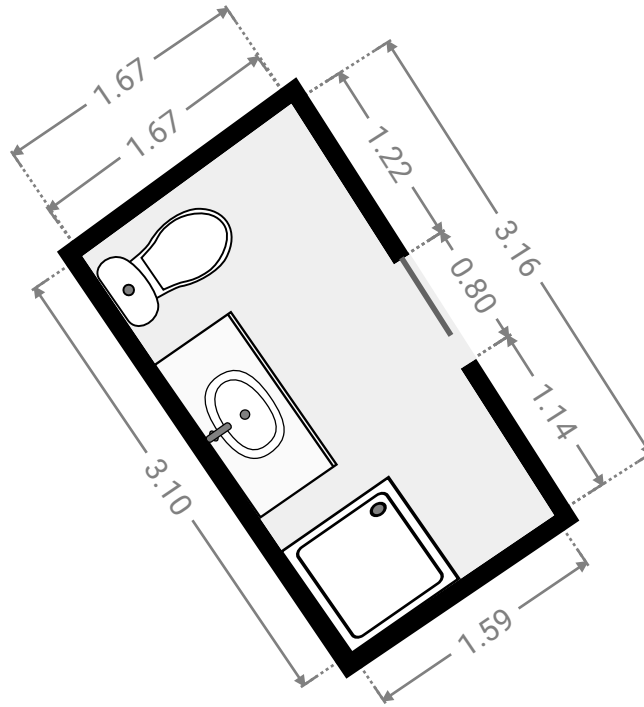
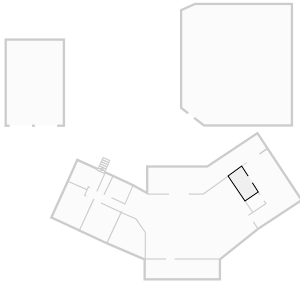

▼ **Bathroom**
Ground Floor

WIDTH: 2.34 m • LENGTH: 2.01 m
AREA: 4.62 m² • PERIMETER: 8.62 m

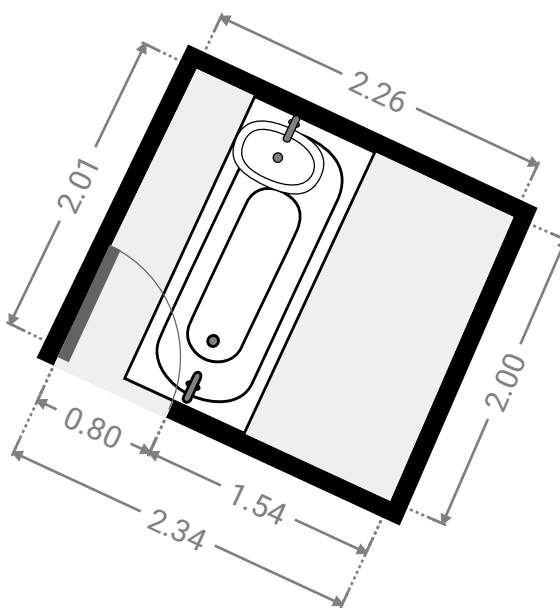
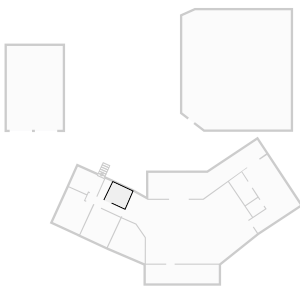

▼ **Bedroom**
Ground Floor

WIDTH: 3.15 m • LENGTH: 4.13 m
AREA: 12.20 m² • PERIMETER: 14.49 m

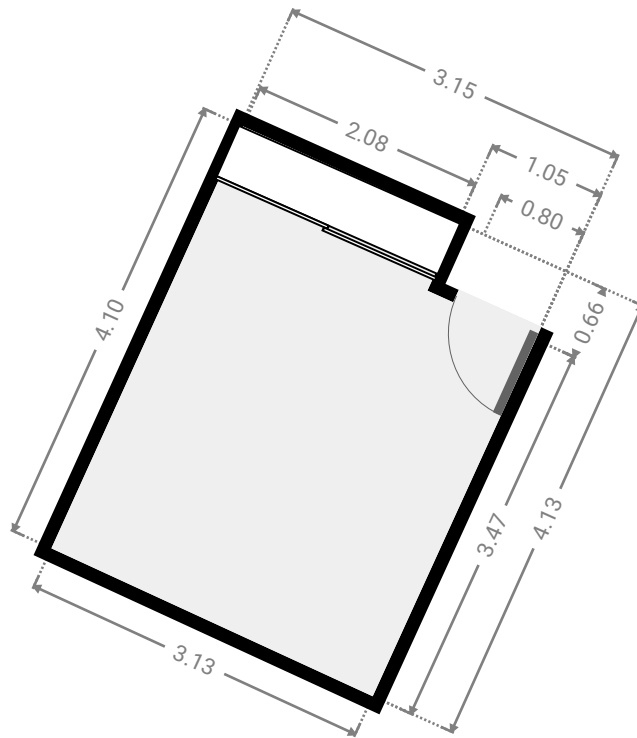
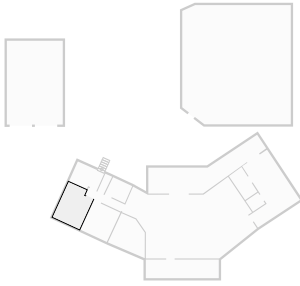

▼ **Bedroom**
Ground Floor

WIDTH: 3.14 m • LENGTH: 3.47 m
AREA: 10.87 m² • PERIMETER: 13.21 m

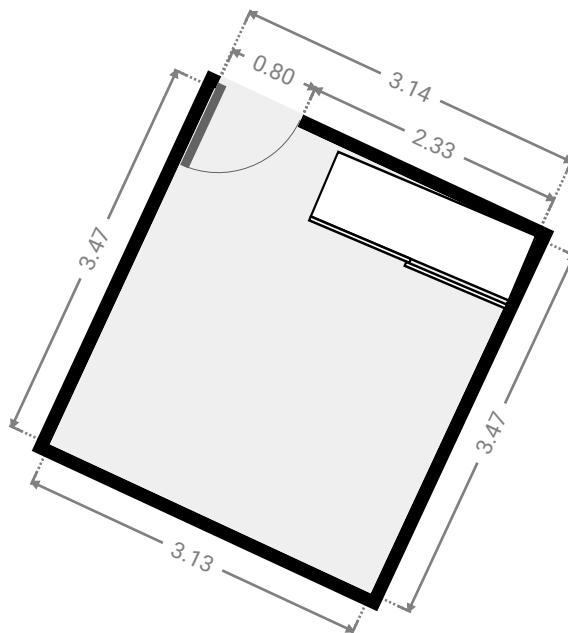
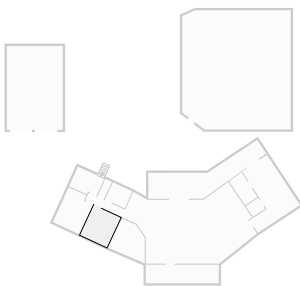

FLOORS: 1

▼ Bedroom Ground Floor

WIDTH: 4.30 m • LENGTH: 3.46 m
AREA: 11.63 m² • PERIMETER: 13.89 m

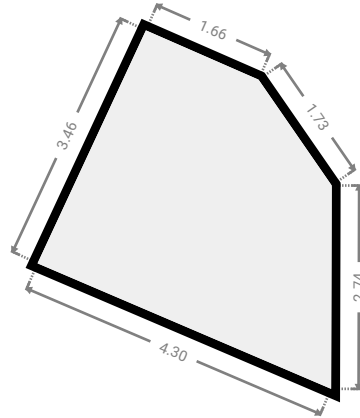
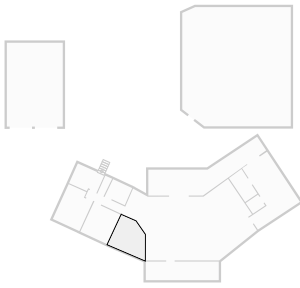

▼ Garage Ground Floor

WIDTH: 6.00 m • LENGTH: 9.00 m
AREA: 54.00 m² • PERIMETER: 30.00 m

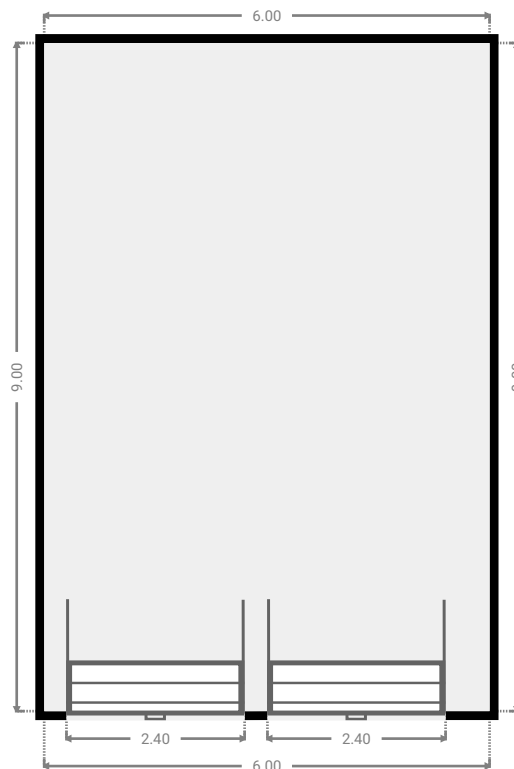
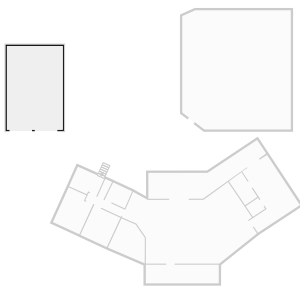

▼ **Hall**
Ground Floor

WIDTH: 4.23 m • LENGTH: 0.87 m
AREA: 3.68 m² • PERIMETER: 10.20 m

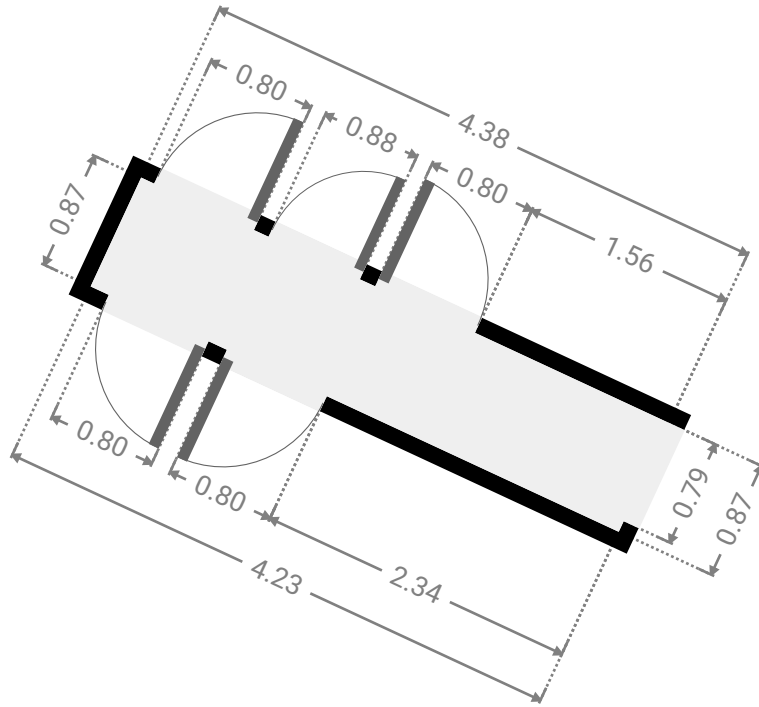
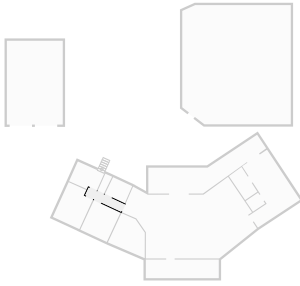

▼ **Laundry Room**
Ground Floor

WIDTH: 3.11 m • LENGTH: 2.32 m
AREA: 6.86 m² • PERIMETER: 10.88 m

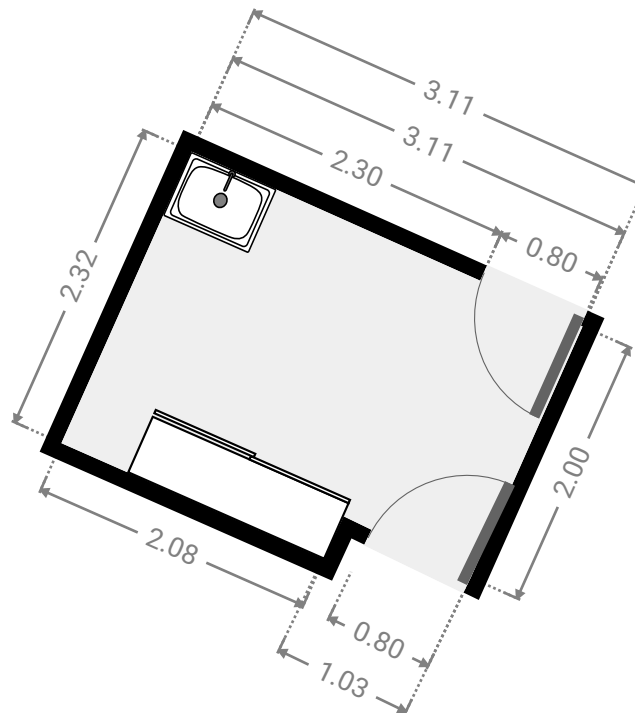
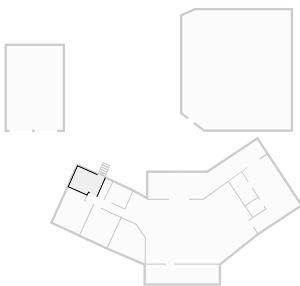

FLOORS: 1

▼ Living Room Ground Floor

WIDTH: 14.49 m • LENGTH: 8.76 m
AREA: 82.63 m² • PERIMETER: 40.22 m

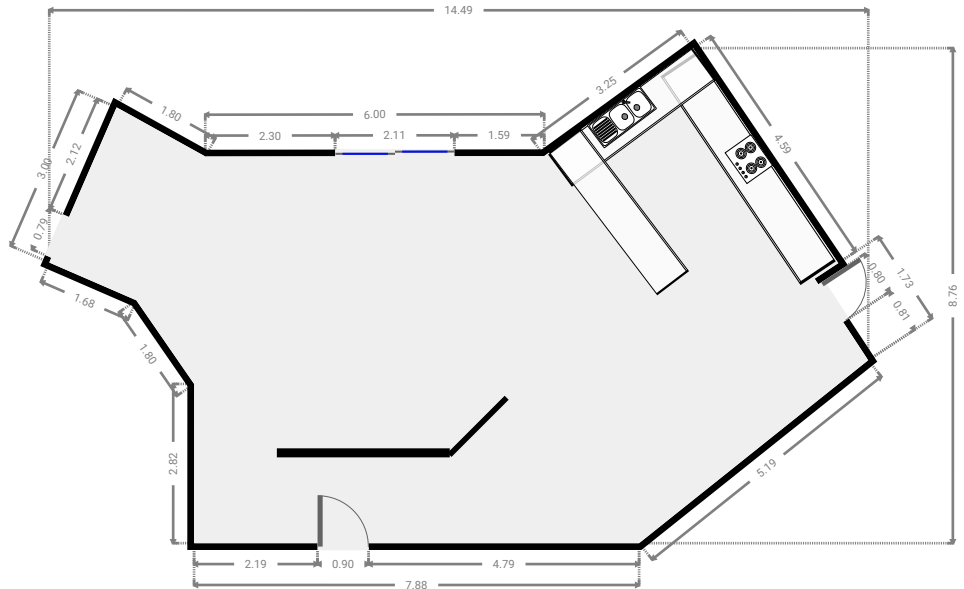
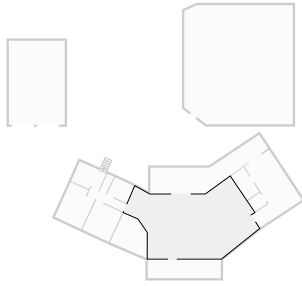

▼ Other Ground Floor

WIDTH: 12.65 m • LENGTH: 6.30 m
AREA: 30.77 m² • PERIMETER: 31.49 m

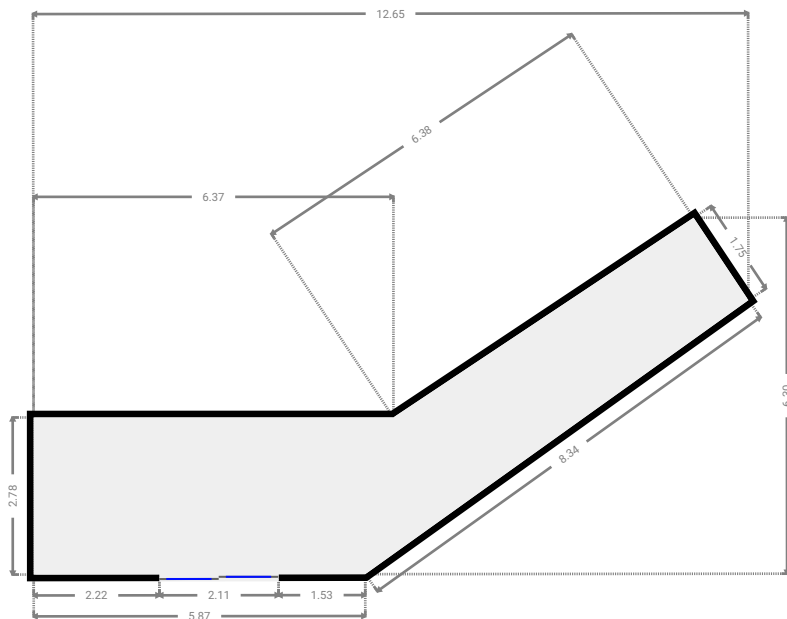
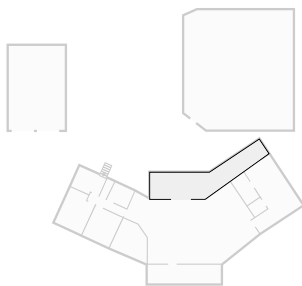

FLOORS: 1

▼ Other Ground Floor

WIDTH: 11.65 m • LENGTH: 12.80 m
AREA: 146.54 m² • PERIMETER: 47.21 m

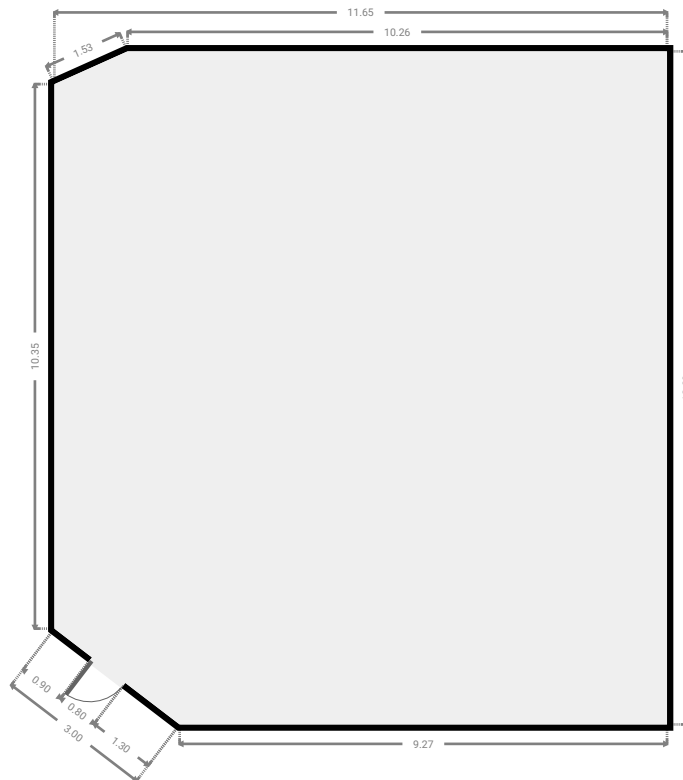
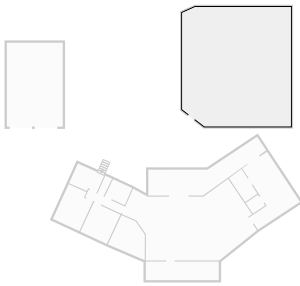

▼ Other Ground Floor

WIDTH: 7.84 m • LENGTH: 2.00 m
AREA: 15.67 m² • PERIMETER: 19.67 m

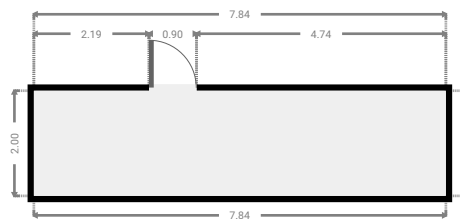
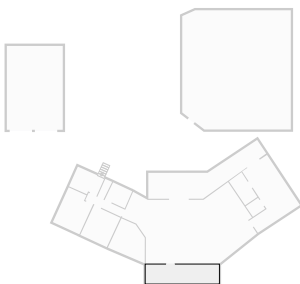

▼ Primary Bedroom Ground Floor

WIDTH: 5.42 m • LENGTH: 6.44 m
AREA: 24.21 m² • PERIMETER: 23.67 m

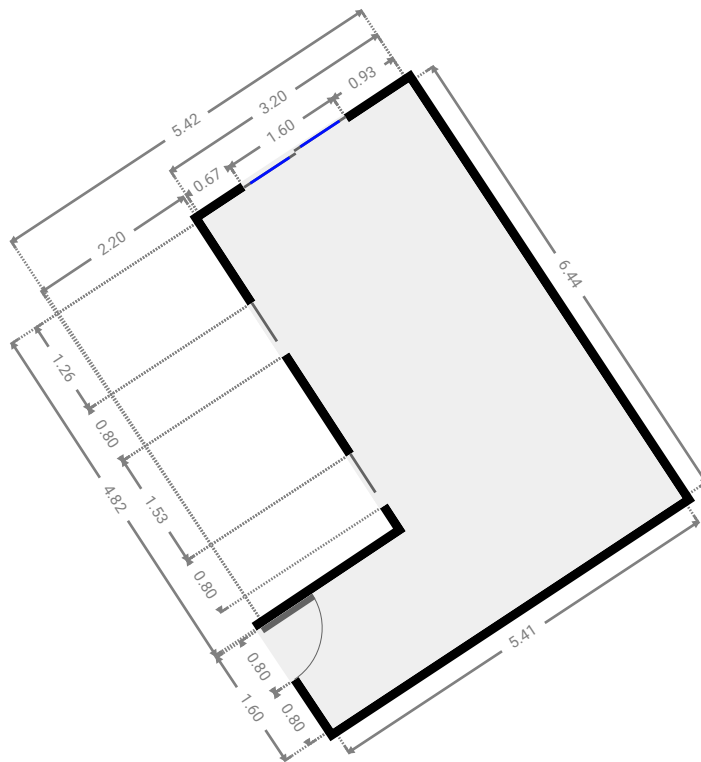
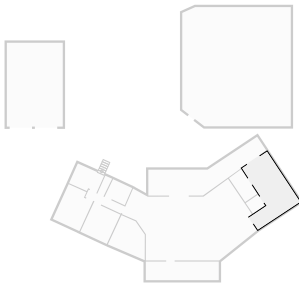

▼ Closet Ground Floor

WIDTH: 1.60 m • LENGTH: 1.40 m
AREA: 2.20 m² • PERIMETER: 5.95 m

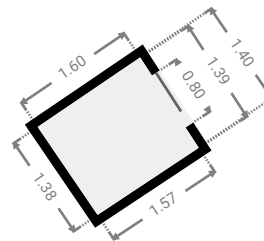
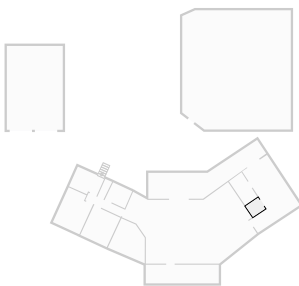

▼ Toilet
Ground Floor

WIDTH: 0.80 m • LENGTH: 2.01 m
AREA: 1.53 m² • PERIMETER: 5.53 m

