

# 74 Varisity Crescent

**SUBMITTED BY**

Ray White Rockhampton Casey  
stockers@cqoz.com

---

**CREATED ON**

2021-11-29

---

**Floors**

1

---

FLOORS: 1

## ▼ Ground Floor

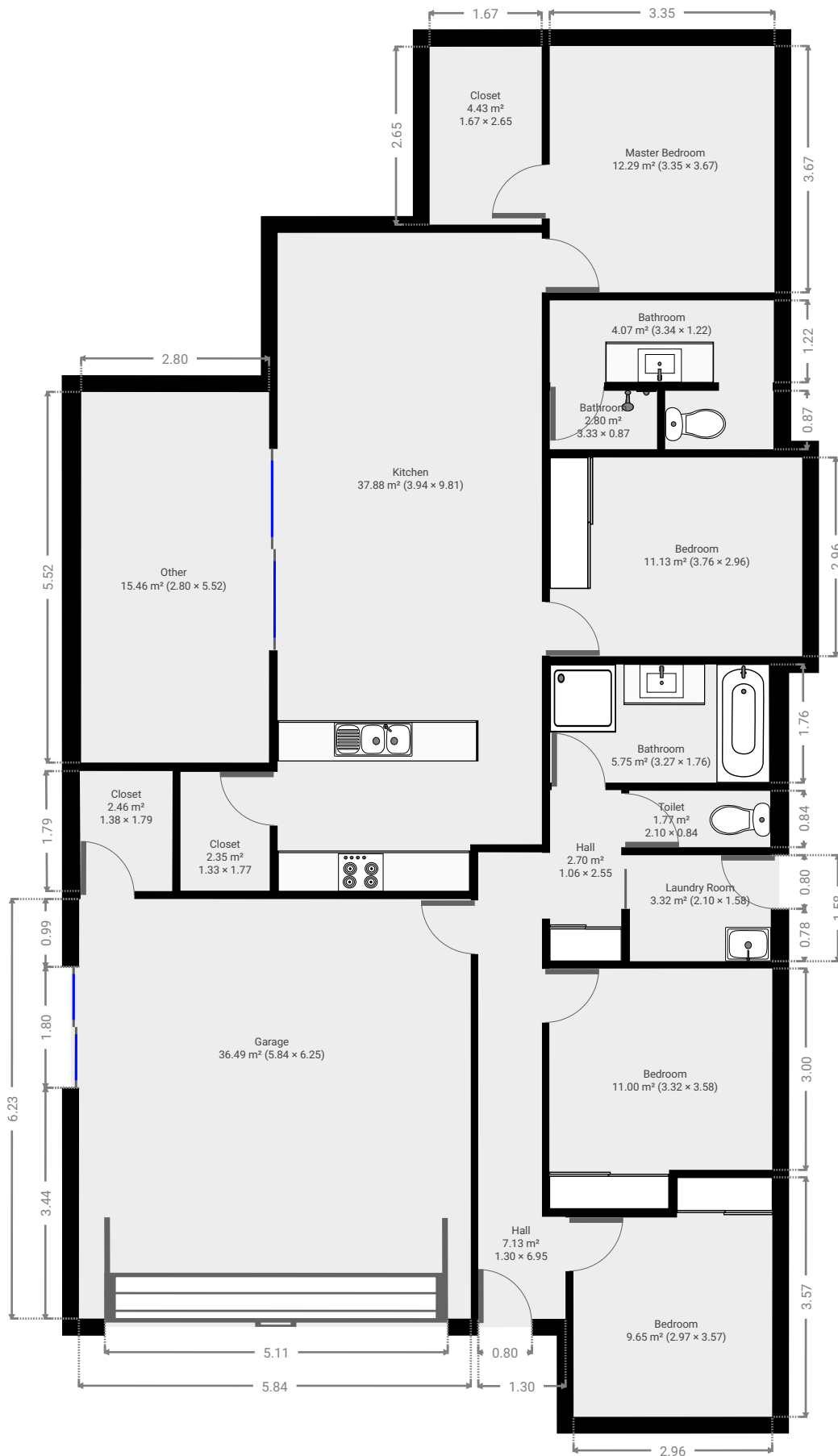

THIS FLOORPLAN IS PROVIDED WITHOUT WARRANTY OF ANY KIND. SENSOPIA DISCLAIMS ANY WARRANTY INCLUDING, WITHOUT LIMITATION, SATISFACTORY QUALITY OR ACCURACY OF DIMENSIONS.

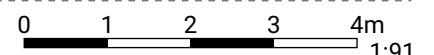

FLOORS: 1

▼ **Closet**  
Ground Floor

WIDTH: 1.33 m • LENGTH: 1.77 m  
AREA: 2.35 m<sup>2</sup> • PERIMETER: 6.20 m

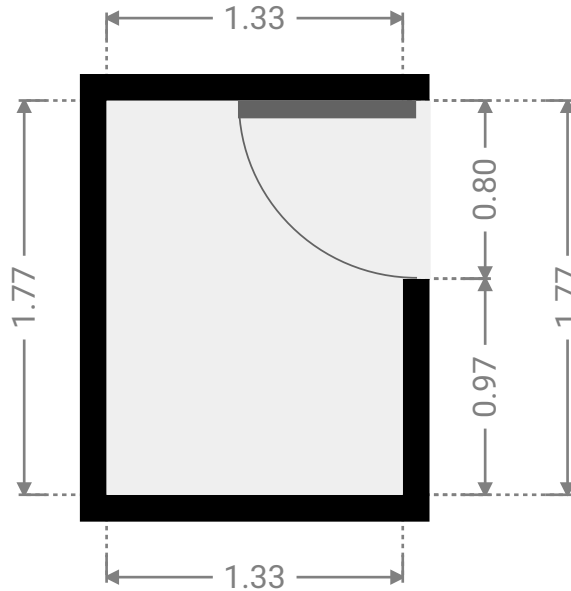
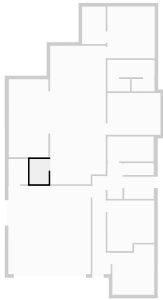

▼ **Closet**  
Ground Floor

WIDTH: 1.38 m • LENGTH: 1.79 m  
AREA: 2.46 m<sup>2</sup> • PERIMETER: 6.33 m

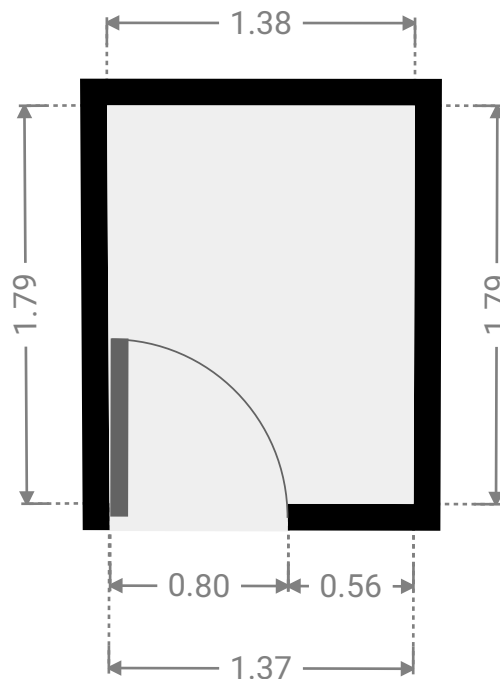
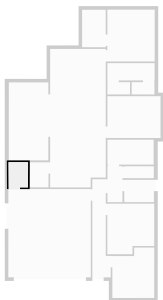

FLOORS: 1

## ▼ Garage Ground Floor

WIDTH: 5.84 m • LENGTH: 6.25 m  
AREA: 36.49 m<sup>2</sup> • PERIMETER: 24.18 m

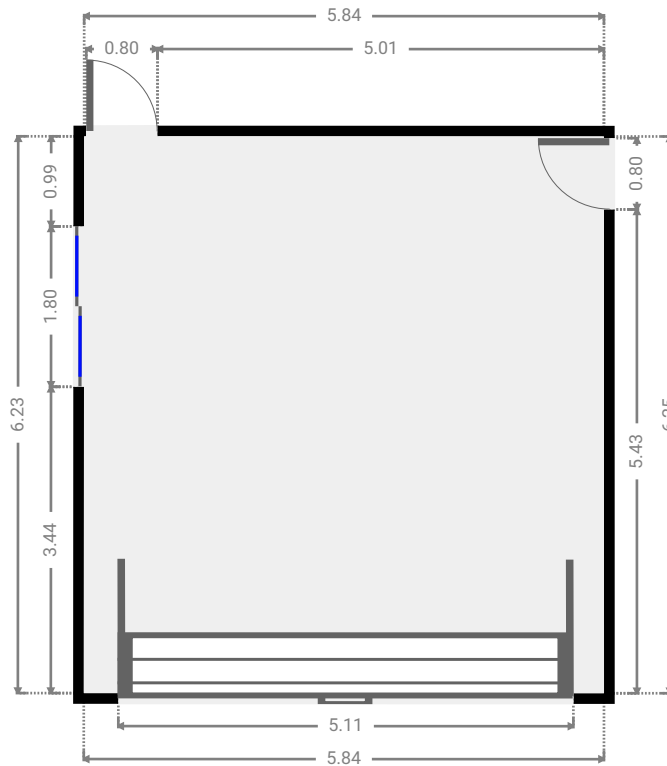
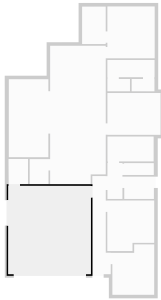

## ▼ Other Ground Floor

WIDTH: 2.80 m • LENGTH: 5.52 m  
AREA: 15.46 m<sup>2</sup> • PERIMETER: 16.64 m

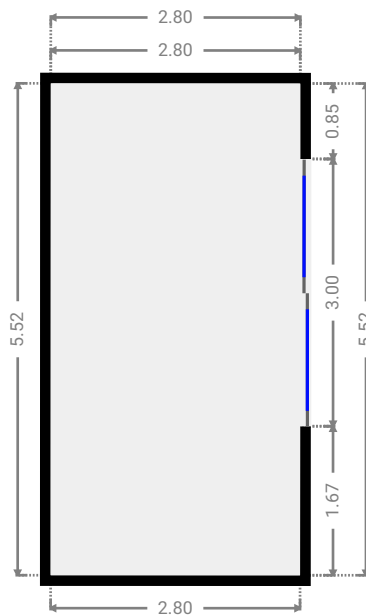
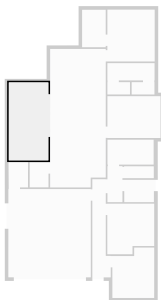

FLOORS: 1

▼ **Closet**  
Ground Floor

WIDTH: 1.67 m • LENGTH: 2.65 m  
AREA: 4.43 m<sup>2</sup> • PERIMETER: 8.64 m

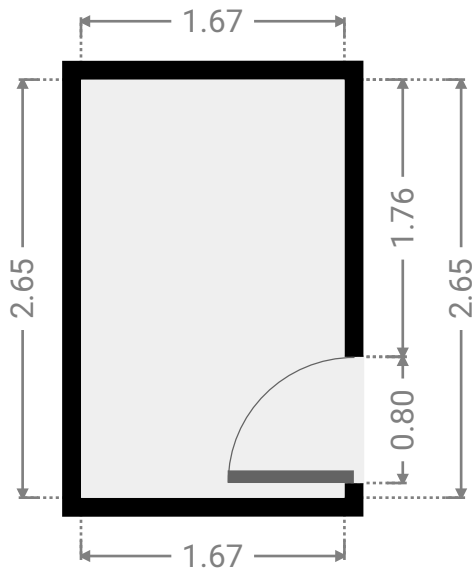

▼ **Master Bedroom**  
Ground Floor

WIDTH: 3.35 m • LENGTH: 3.67 m  
AREA: 12.29 m<sup>2</sup> • PERIMETER: 14.04 m

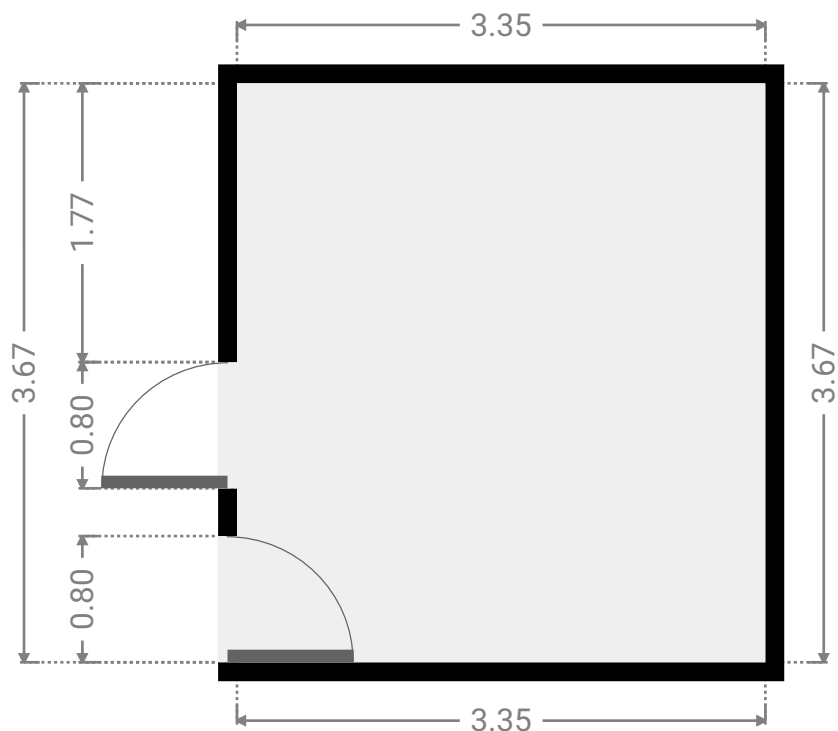

FLOORS: 1

▼ **Bathroom**  
Ground Floor

WIDTH: 3.33 m • LENGTH: 0.87 m  
AREA: 2.80 m<sup>2</sup> • PERIMETER: 10.15 m

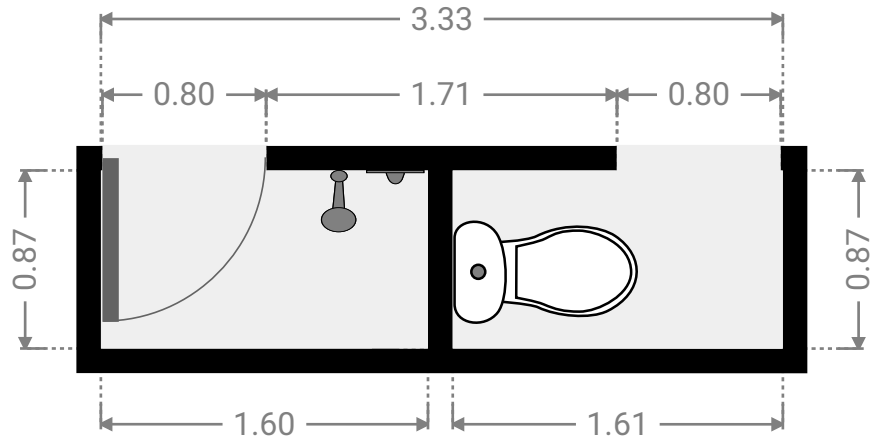
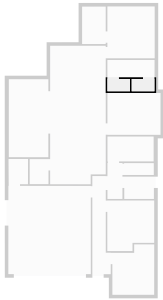

▼ **Bathroom**  
Ground Floor

WIDTH: 3.34 m • LENGTH: 1.22 m  
AREA: 4.07 m<sup>2</sup> • PERIMETER: 9.12 m

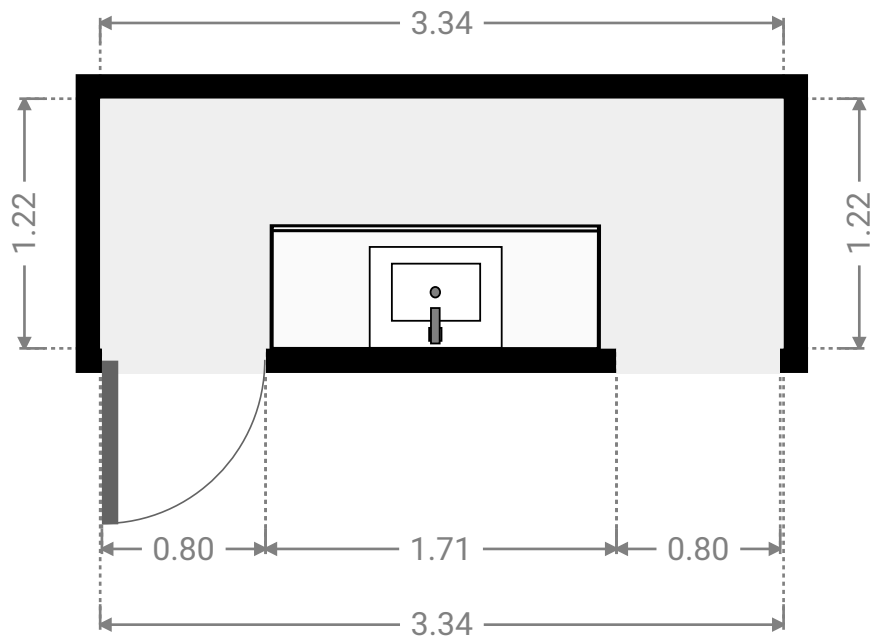

FLOORS: 1

## ▼ Bedroom Ground Floor

WIDTH: 3.76 m • LENGTH: 2.96 m  
AREA: 11.13 m<sup>2</sup> • PERIMETER: 13.44 m

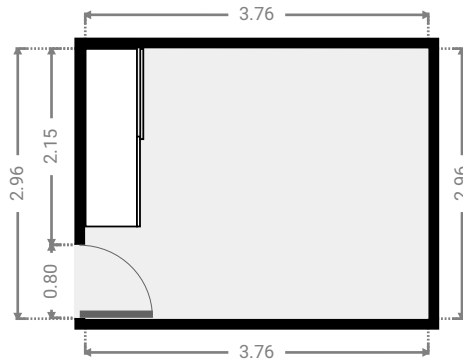
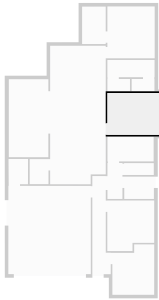

## ▼ Hall Ground Floor

WIDTH: 1.30 m • LENGTH: 6.95 m  
AREA: 7.13 m<sup>2</sup> • PERIMETER: 16.50 m

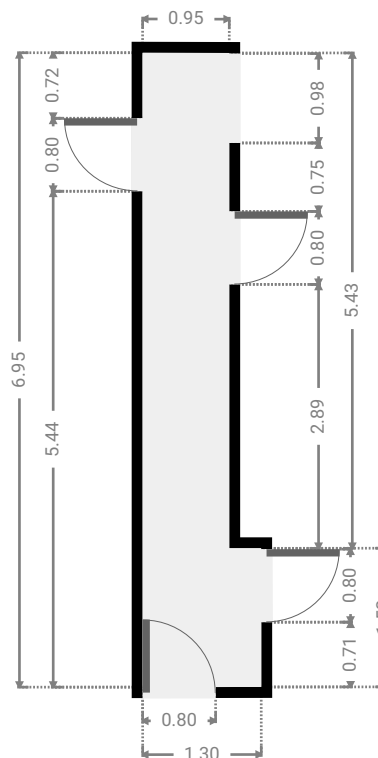

FLOORS: 1

## ▼ Kitchen Ground Floor

WIDTH: 3.94 m • LENGTH: 9.81 m  
AREA: 37.88 m<sup>2</sup> • PERIMETER: 27.50 m

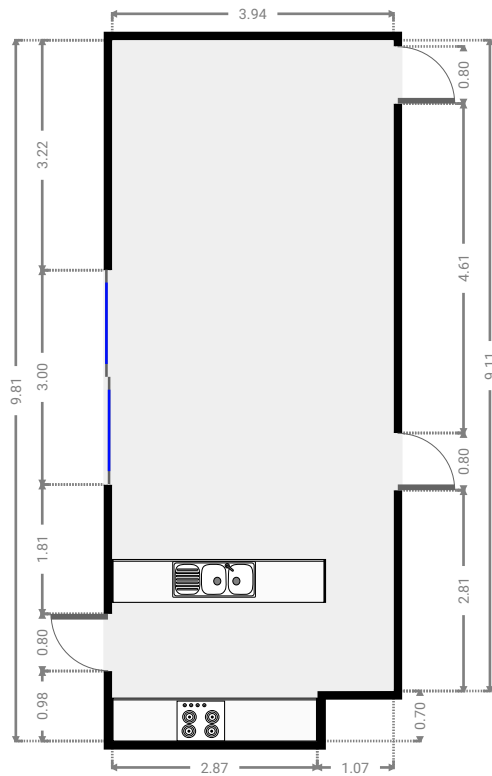
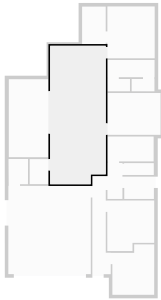

## ▼ Bathroom Ground Floor

WIDTH: 3.27 m • LENGTH: 1.76 m  
AREA: 5.75 m<sup>2</sup> • PERIMETER: 10.06 m

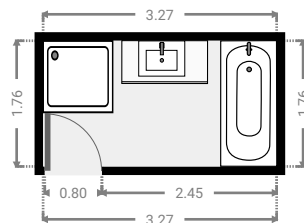
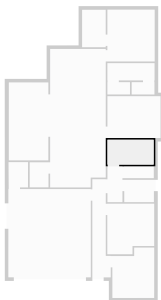



## ▼ Toilet Ground Floor

WIDTH: 2.10 m • LENGTH: 0.84 m  
AREA: 1.77 m<sup>2</sup> • PERIMETER: 5.88 m

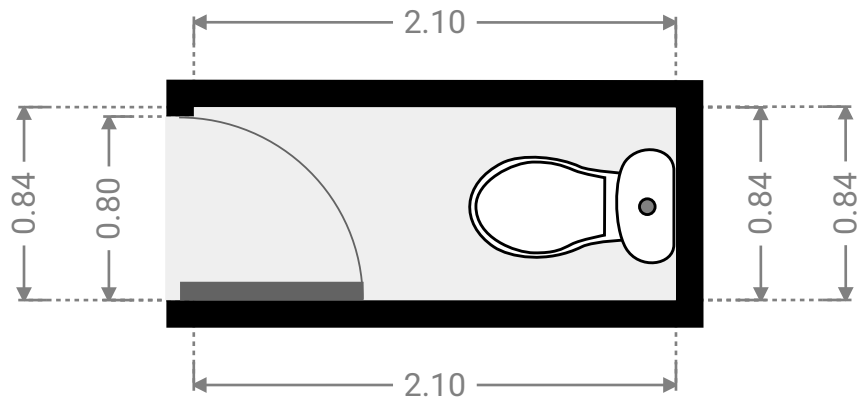
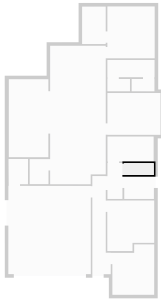

## ▼ Laundry Room Ground Floor

WIDTH: 2.10 m • LENGTH: 1.58 m  
AREA: 3.32 m<sup>2</sup> • PERIMETER: 7.36 m

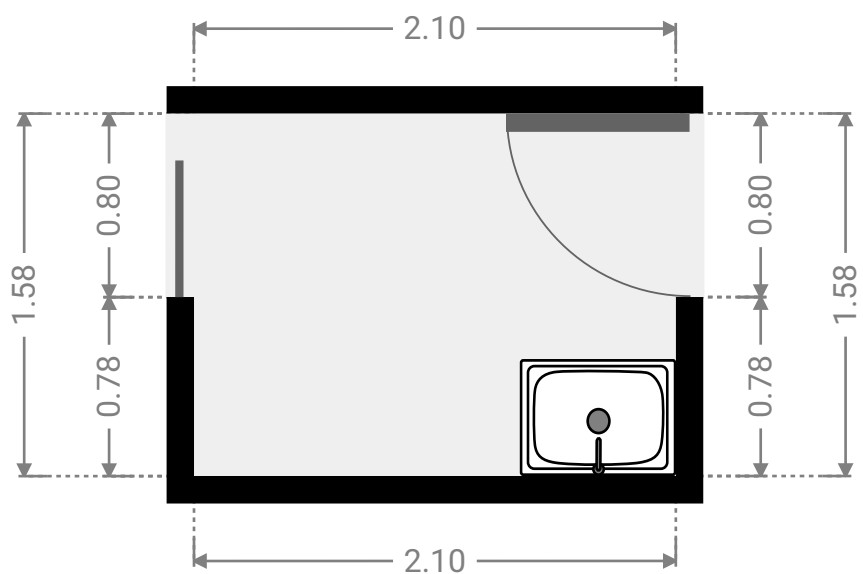
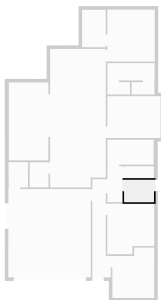

FLOORS: 1

▼ **Hall**  
Ground Floor

WIDTH: 1.06 m • LENGTH: 2.55 m  
AREA: 2.70 m<sup>2</sup> • PERIMETER: 7.22 m

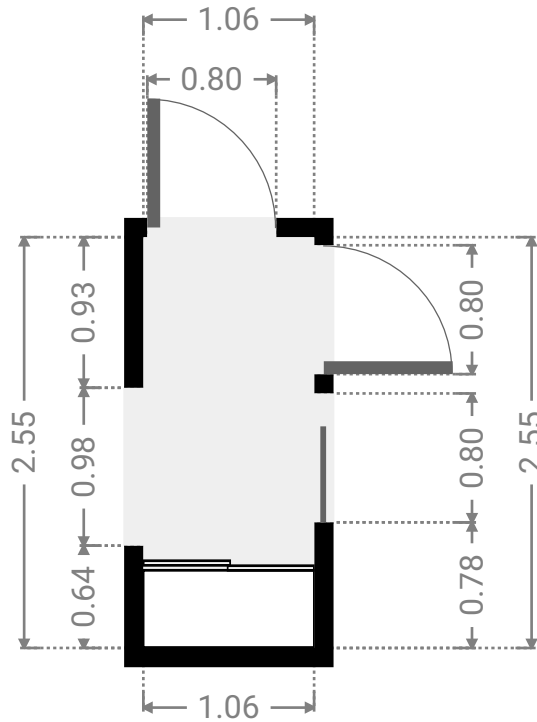
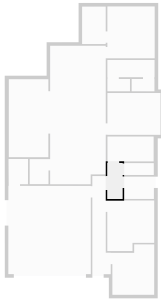

▼ **Bedroom**  
Ground Floor

WIDTH: 3.32 m • LENGTH: 3.58 m  
AREA: 11.00 m<sup>2</sup> • PERIMETER: 13.81 m

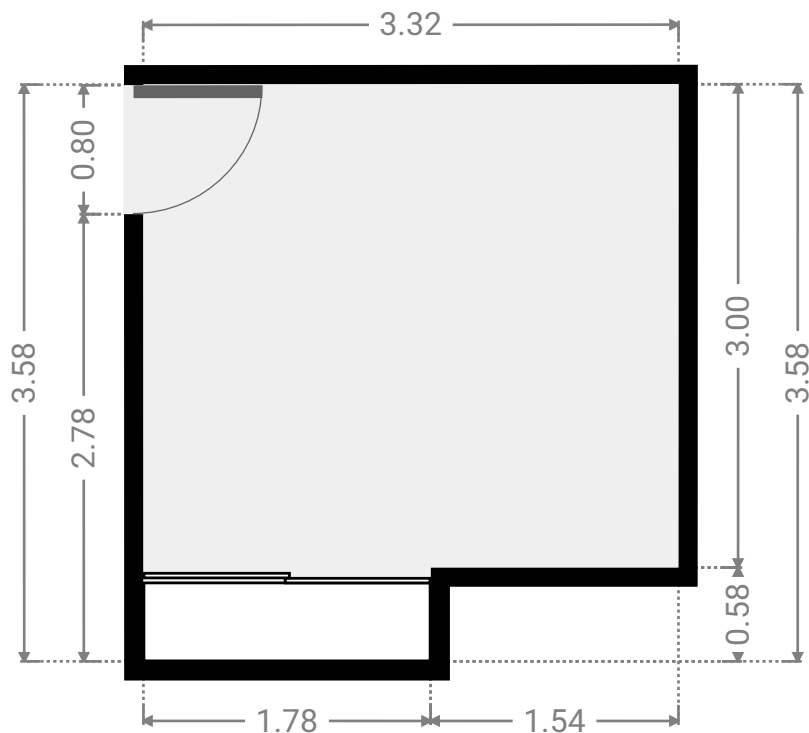
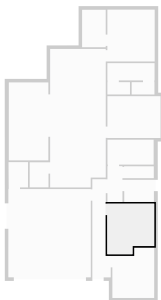

FLOORS: 1

## ▼ Bedroom Ground Floor

WIDTH: 2.97 m • LENGTH: 3.57 m  
AREA: 9.65 m<sup>2</sup> • PERIMETER: 13.06 m

