

73 Hamilton Avenue

Created on
2021-09-02

Floors
2

▼ Ground Floor

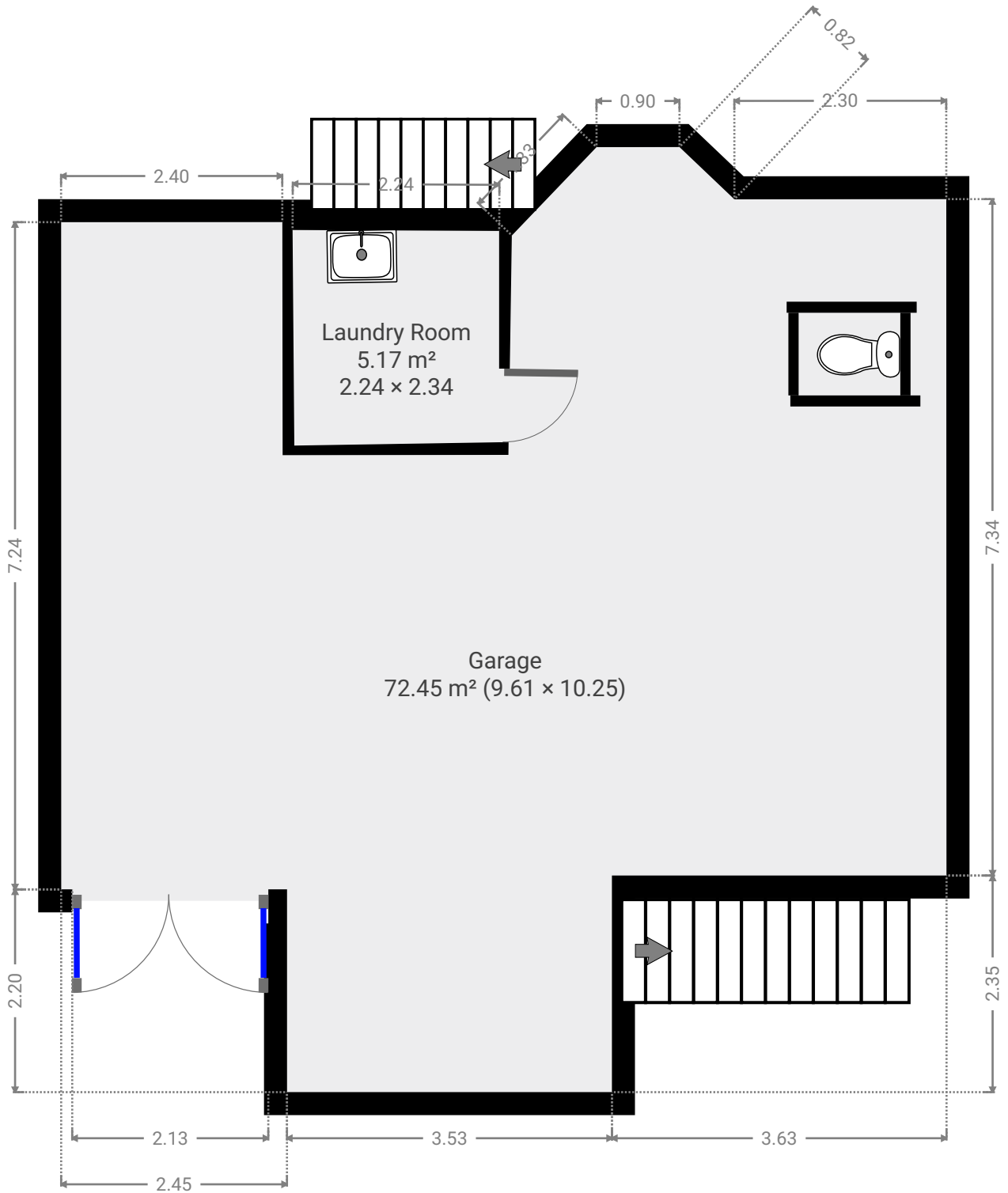

▼ **Garage**
Ground Floor

WIDTH: 9.61 m • LENGTH: 10.25 m
AREA: 72.45 m² • PERIMETER: 43.85 m

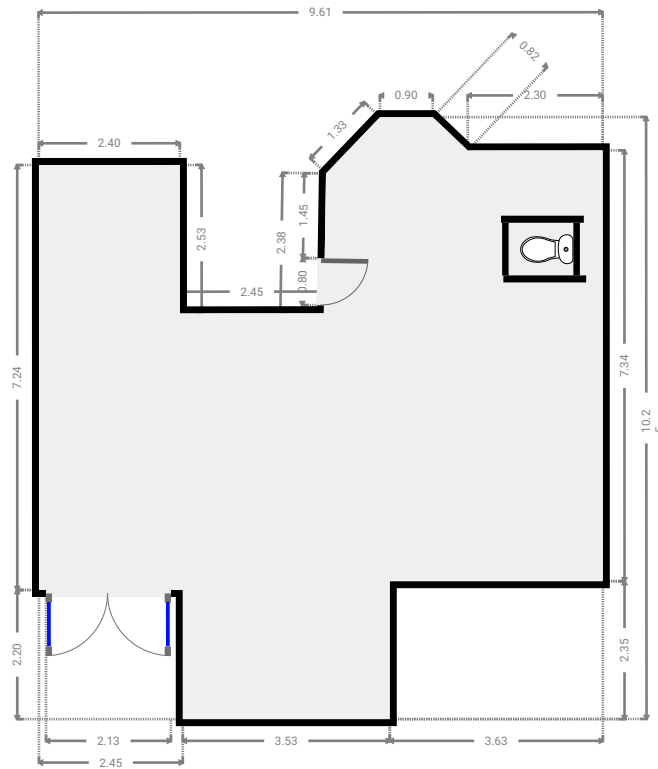
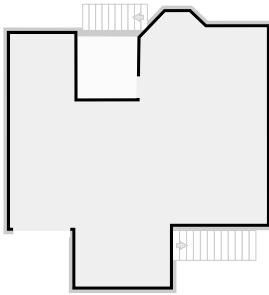

▼ **Laundry Room**
Ground Floor

WIDTH: 2.24 m • LENGTH: 2.34 m
AREA: 5.17 m² • PERIMETER: 9.10 m

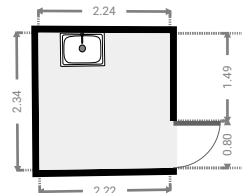
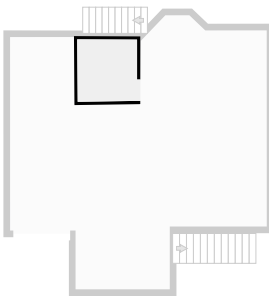

▼ 1st Floor



▼ Living Room
1st Floor

WIDTH: 3.57 m • LENGTH: 4.42 m
AREA: 15.78 m² • PERIMETER: 15.98 m

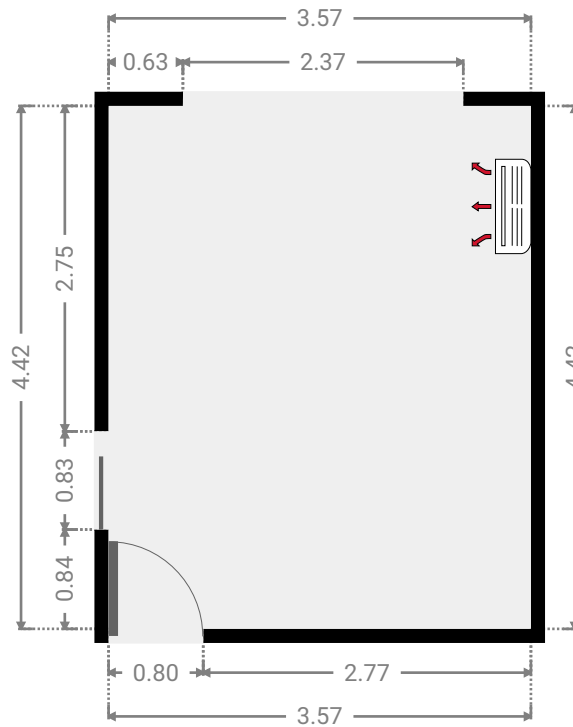
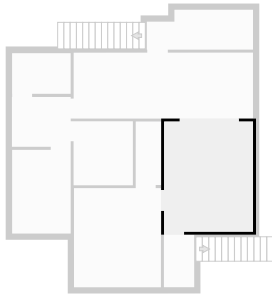

▼ Master Bedroom
1st Floor

WIDTH: 3.49 m • LENGTH: 3.98 m
AREA: 13.89 m² • PERIMETER: 14.94 m

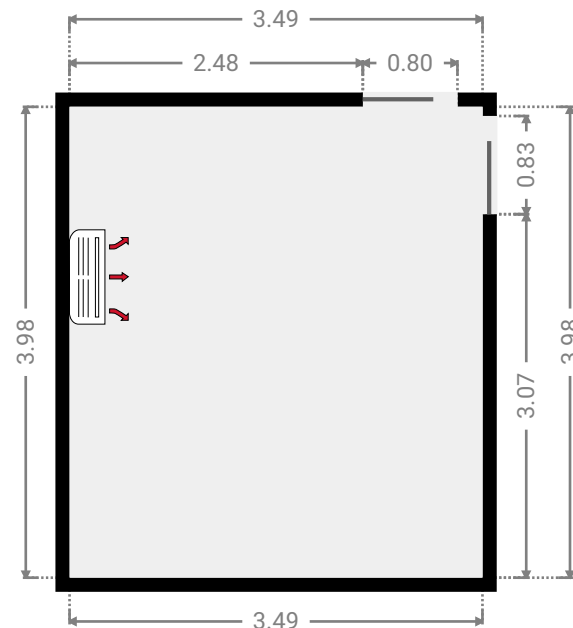
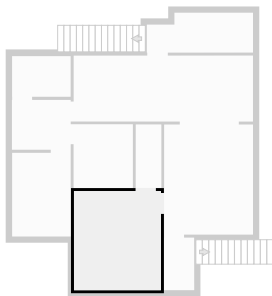

▼ Closet
1st Floor

WIDTH: 1.03 m • LENGTH: 2.55 m
AREA: 2.63 m² • PERIMETER: 7.16 m

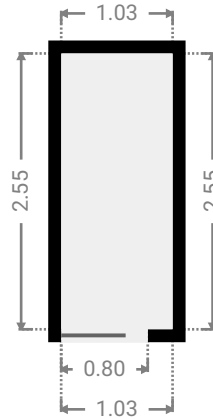
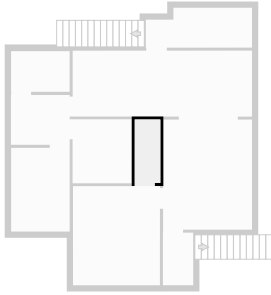

▼ Kitchen
1st Floor

WIDTH: 7.20 m • LENGTH: 2.65 m
AREA: 19.06 m² • PERIMETER: 19.69 m

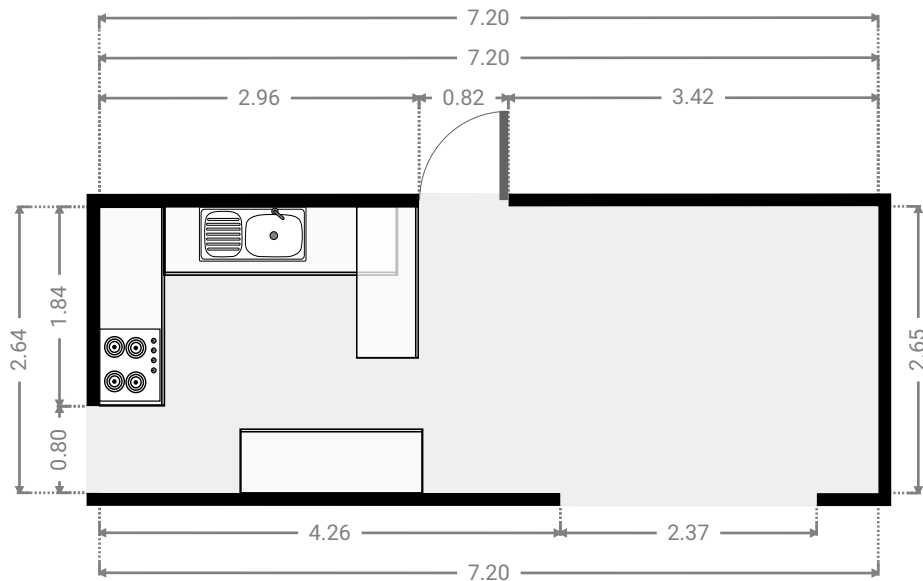
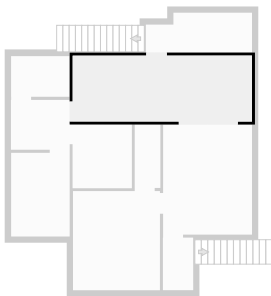

▼ **Bedroom**
1st Floor

WIDTH: 2.38 m • LENGTH: 2.57 m
AREA: 6.12 m² • PERIMETER: 9.90 m

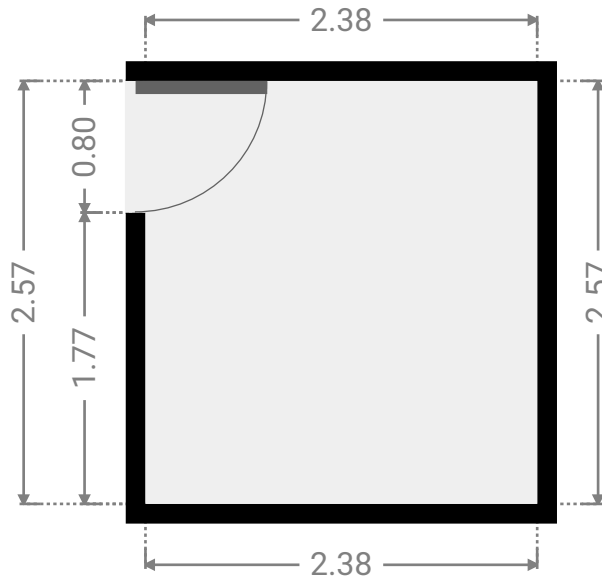
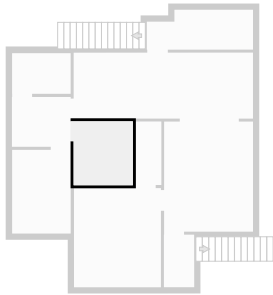

▼ **Hall**
1st Floor

WIDTH: 2.36 m • LENGTH: 2.00 m
AREA: 4.72 m² • PERIMETER: 8.72 m

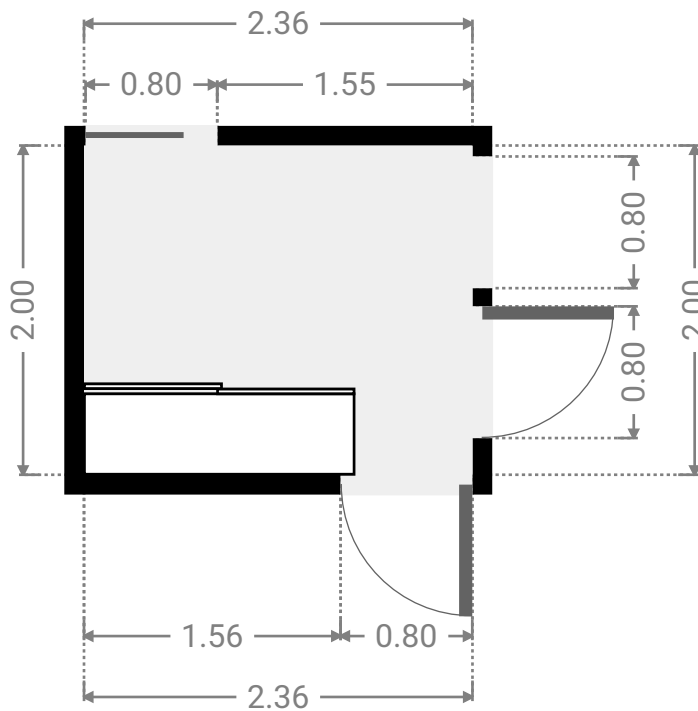
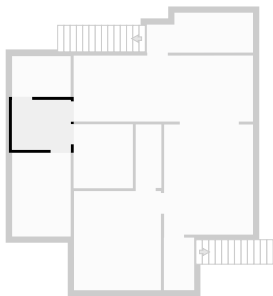

▼ **Bathroom**
1st Floor

WIDTH: 2.35 m • LENGTH: 1.63 m
AREA: 3.83 m² • PERIMETER: 7.96 m

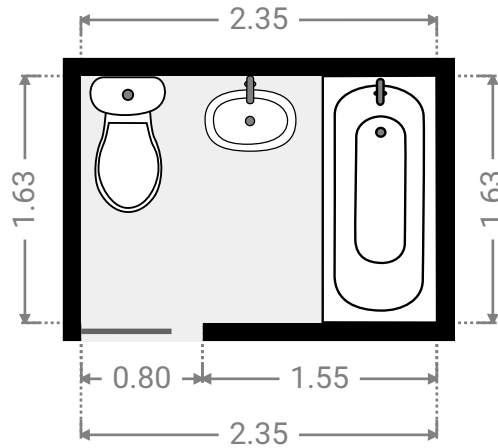
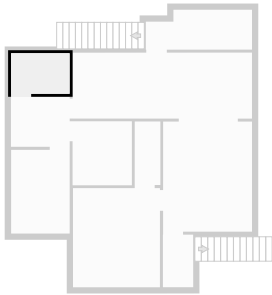

▼ **Bedroom**
1st Floor

WIDTH: 2.35 m • LENGTH: 3.36 m
AREA: 7.90 m² • PERIMETER: 11.42 m

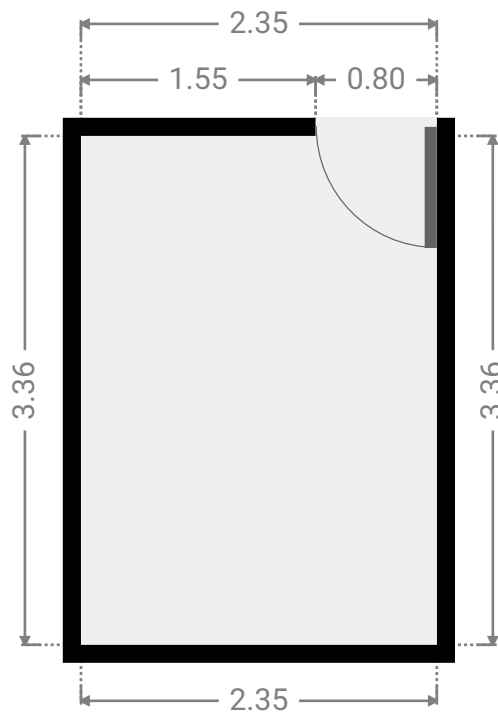
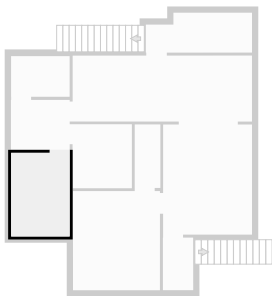

▼ **Hall**
1st Floor

WIDTH: 0.99 m • LENGTH: 1.12 m
AREA: 1.11 m² • PERIMETER: 4.22 m

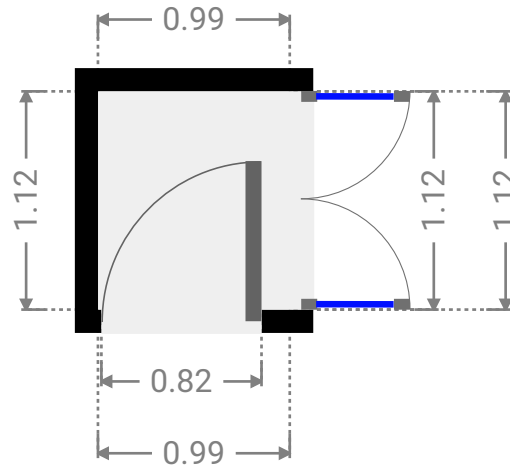
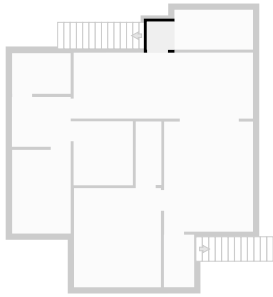

▼ **Other**
1st Floor

WIDTH: 3.16 m • LENGTH: 1.60 m
AREA: 5.05 m² • PERIMETER: 9.51 m

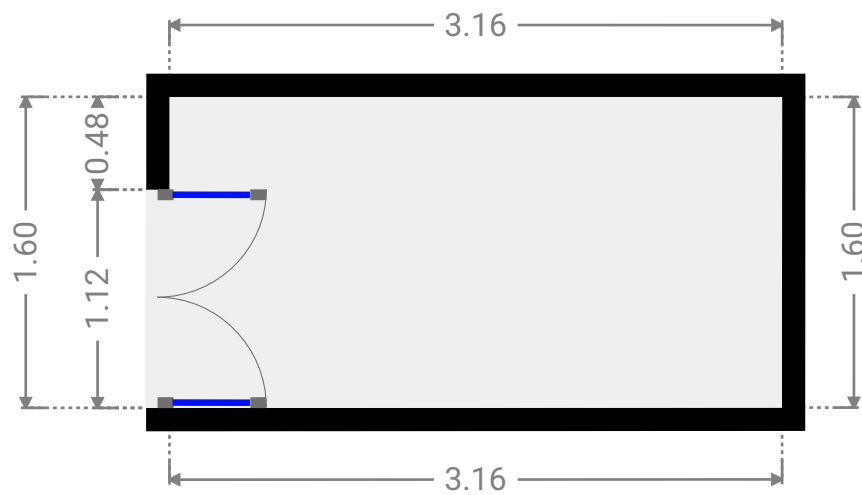
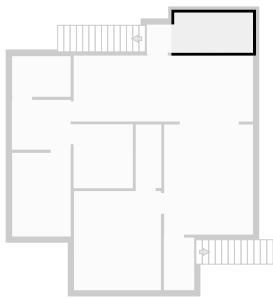

▼ Other
1st Floor

WIDTH: 1.22 m • LENGTH: 2.11 m
AREA: 2.57 m² • PERIMETER: 6.65 m

