

# 71 Sunset Drive

Created on  
2020-11-26

Floors  
1

▼ Ground Floor



▼ Bathroom  
Ground Floor

WIDTH:3.48 m · LENGTH:2.00 m  
AREA:6.27 m<sup>2</sup> · PERIMETER:10.96 m

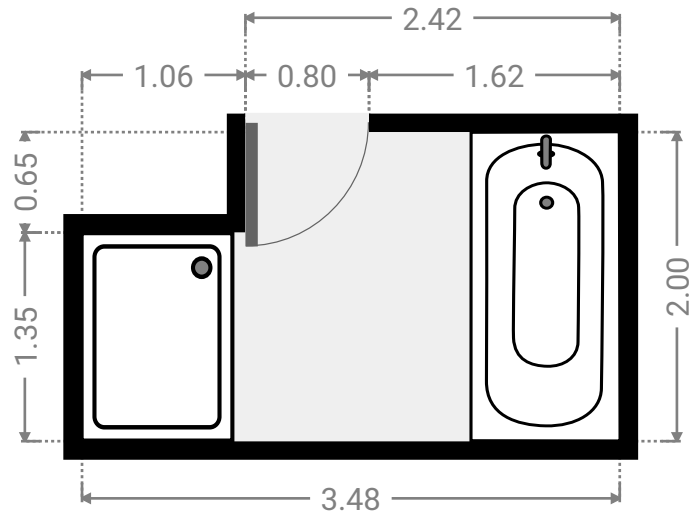
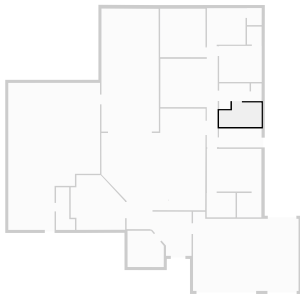

▼ Other  
Ground Floor

WIDTH:1.56 m · LENGTH:3.50 m  
AREA:4.22 m<sup>2</sup> · PERIMETER:10.12 m

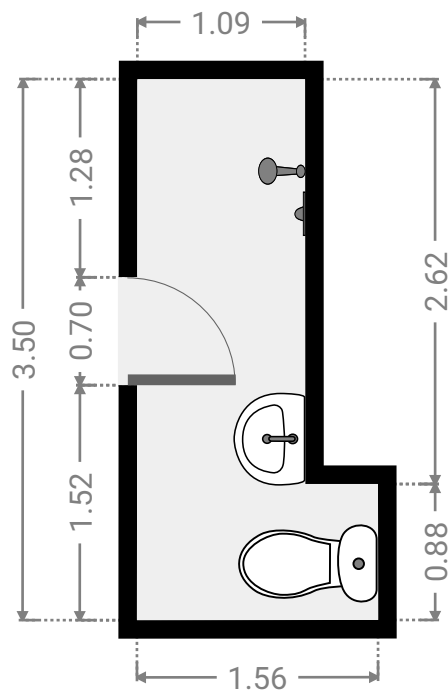
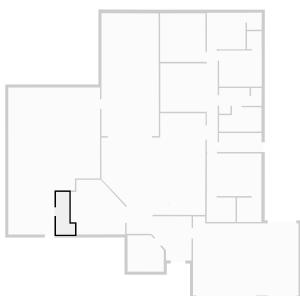

## ▼ Other Ground Floor

WIDTH:7.54 m · LENGTH:12.08 m  
AREA:75.49 m<sup>2</sup> · PERIMETER:39.24 m

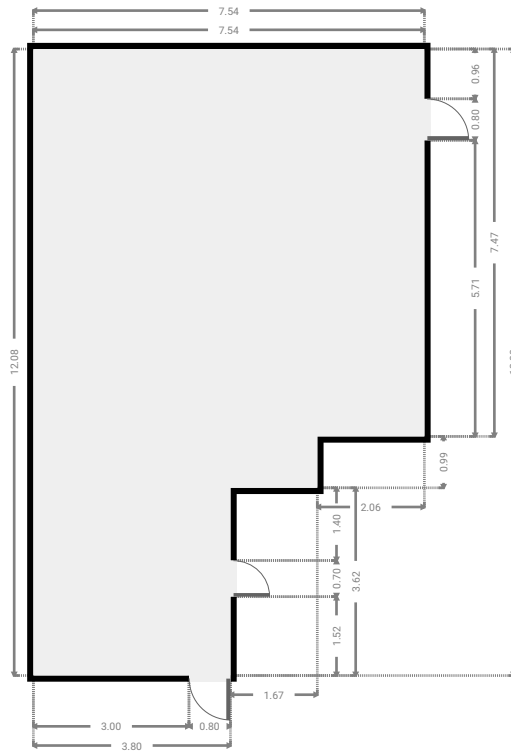
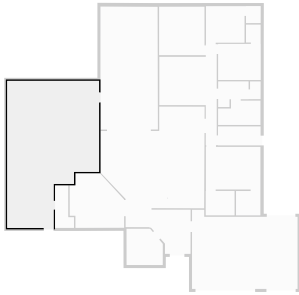

## ▼ Other Ground Floor

WIDTH:4.72 m · LENGTH:10.11 m  
AREA:47.49 m<sup>2</sup> · PERIMETER:29.59 m

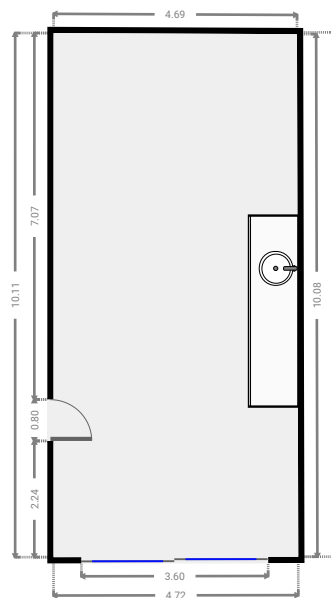
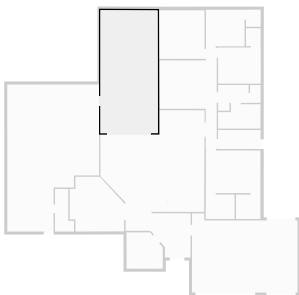

▼ Bedroom

Ground Floor

WIDTH:3.73 m · LENGTH:3.98 m  
AREA:14.85 m<sup>2</sup> · PERIMETER:15.42 m

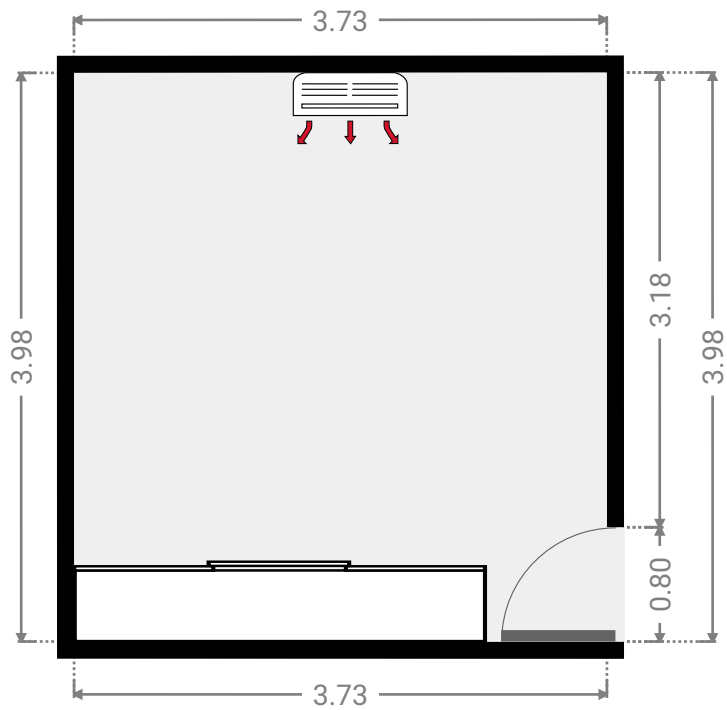
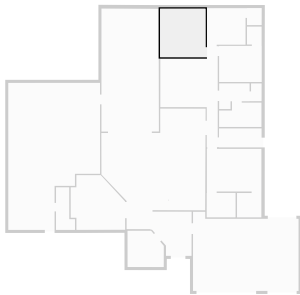

▼ Closet

Ground Floor

WIDTH:1.21 m · LENGTH:1.40 m  
AREA:1.69 m<sup>2</sup> · PERIMETER:5.21 m

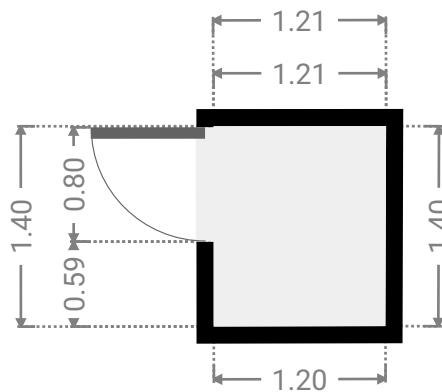
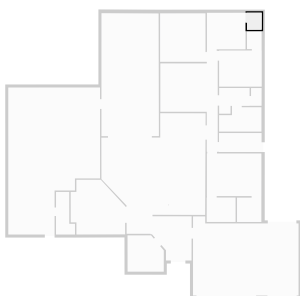

▼ **Bedroom**  
Ground Floor

WIDTH:3.17 m · LENGTH:3.00 m  
AREA:9.51 m<sup>2</sup> · PERIMETER:12.34 m

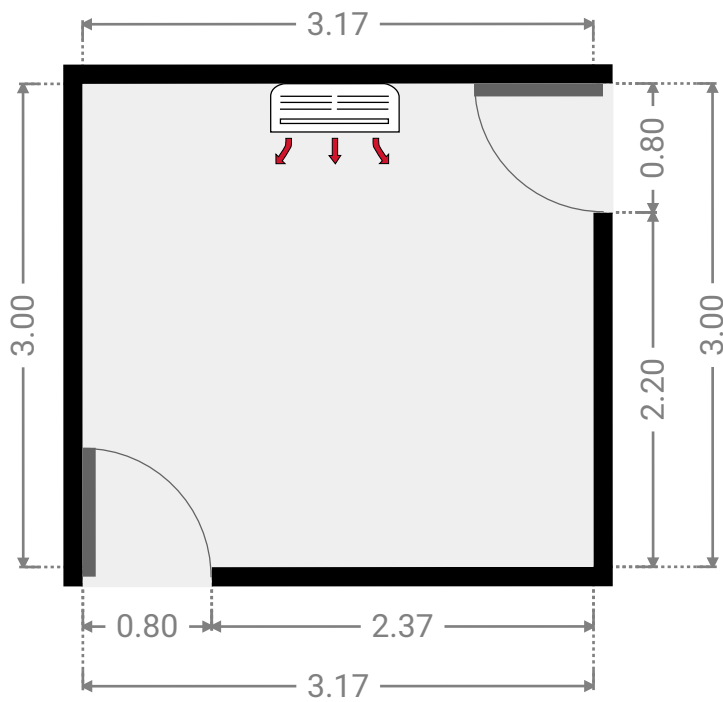
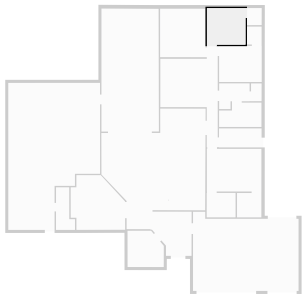

▼ **Closet**  
Ground Floor

WIDTH:1.20 m · LENGTH:1.47 m  
AREA:1.76 m<sup>2</sup> · PERIMETER:5.34 m

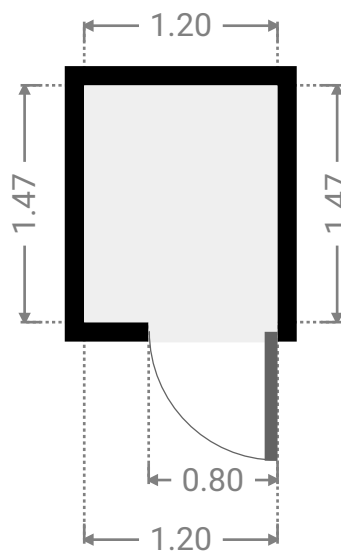
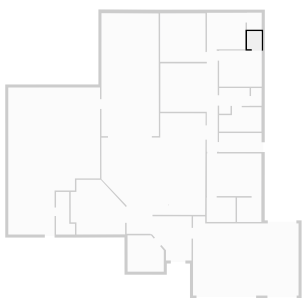

▼ **Bedroom**  
Ground Floor

WIDTH:3.50 m · LENGTH:2.97 m  
AREA:10.39 m<sup>2</sup> · PERIMETER:12.94 m

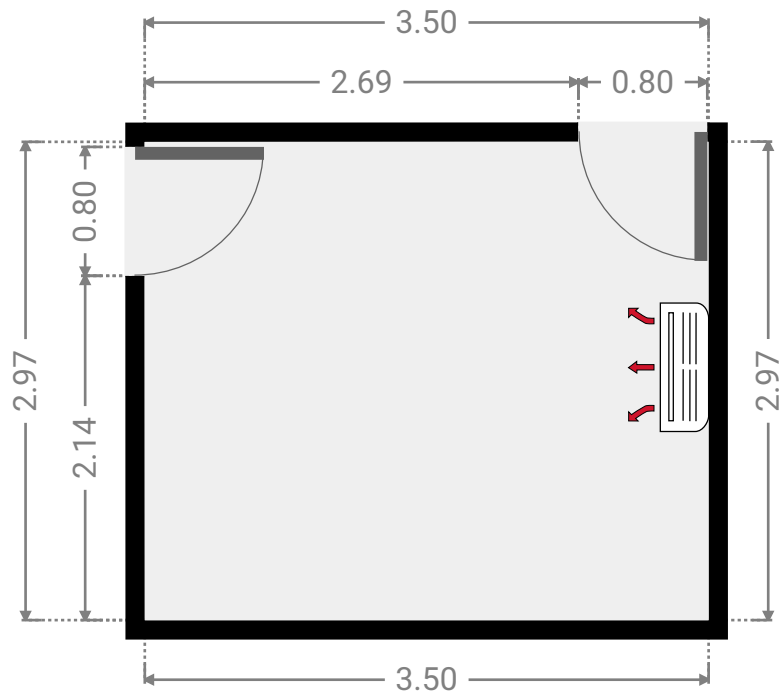
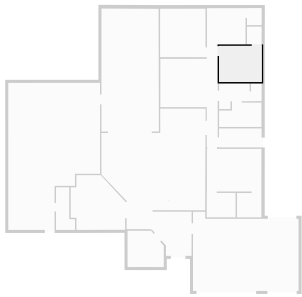

▼ **Toilet**  
Ground Floor

WIDTH:0.87 m · LENGTH:1.46 m  
AREA:1.26 m<sup>2</sup> · PERIMETER:4.65 m

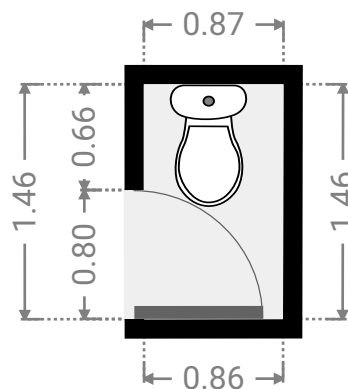
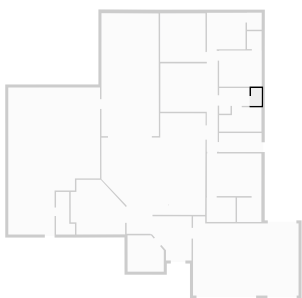

▼ **Hall**  
Ground Floor

WIDTH:2.50 m · LENGTH:2.11 m  
AREA:4.27 m<sup>2</sup> · PERIMETER:9.22 m

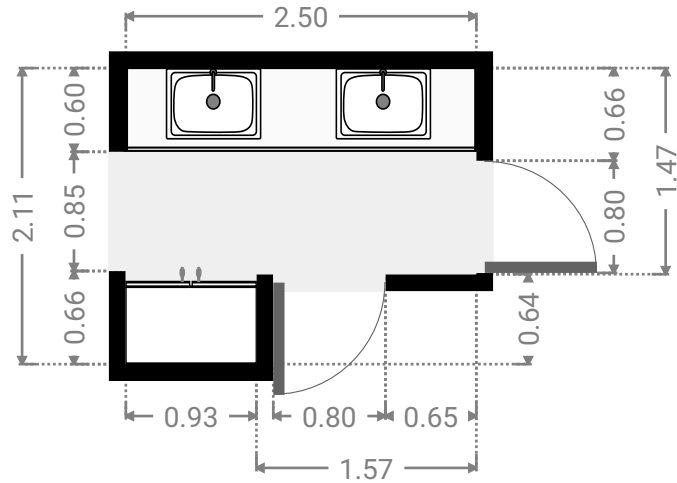
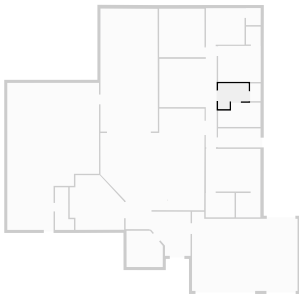

▼ **Hall**  
Ground Floor

WIDTH:3.26 m · LENGTH:3.63 m  
AREA:10.10 m<sup>2</sup> · PERIMETER:13.05 m

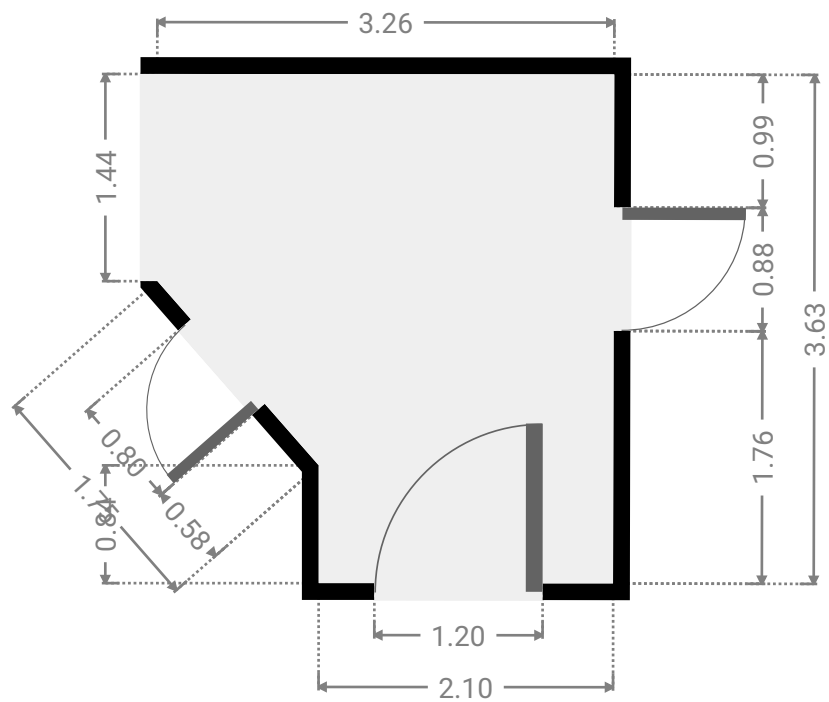
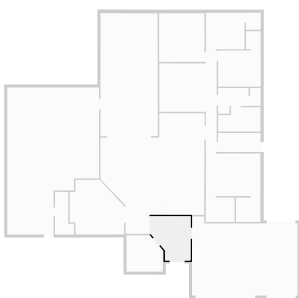



▼ **Laundry Room**  
Ground Floor

WIDTH:3.50 m · LENGTH:1.56 m  
AREA:5.46 m<sup>2</sup> · PERIMETER:10.12 m

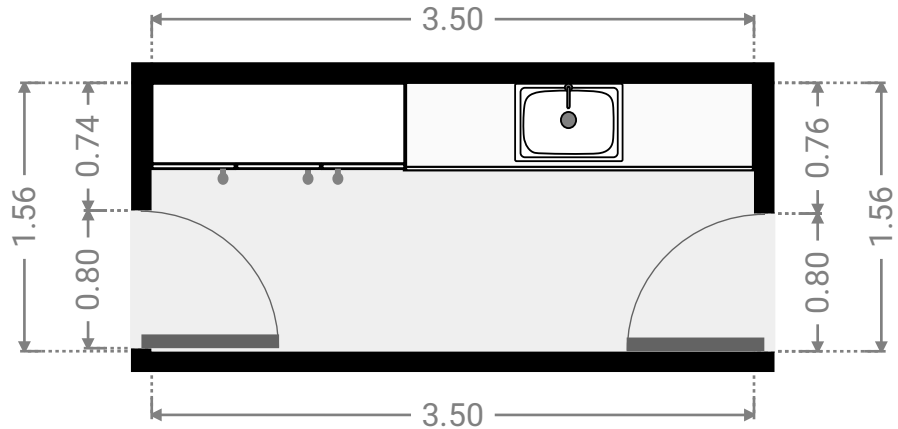

▼ **Closet**  
Ground Floor

WIDTH:2.37 m · LENGTH:2.01 m  
AREA:4.75 m<sup>2</sup> · PERIMETER:8.75 m

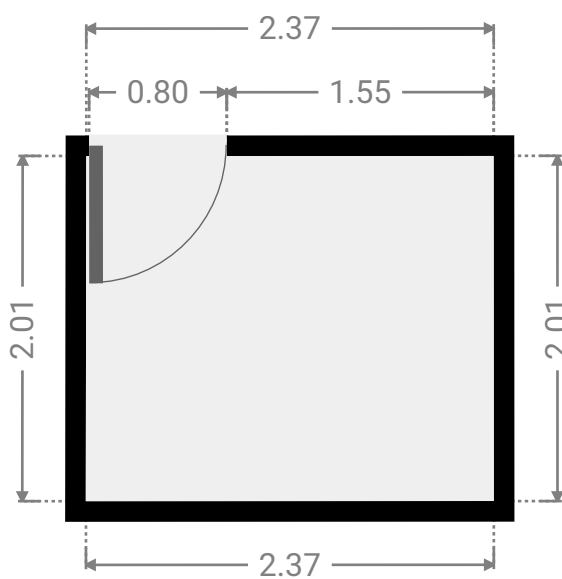
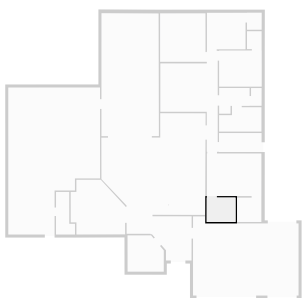

FLOORS:1

▼ **Bathroom**  
Ground Floor

WIDTH:2.00 m · LENGTH:2.00 m  
AREA:4.00 m<sup>2</sup> · PERIMETER:8.00 m

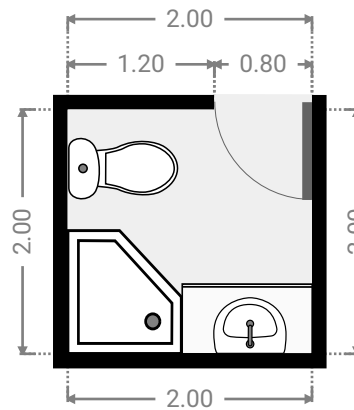
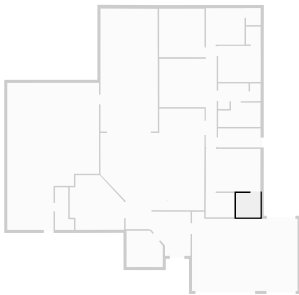

▼ **Master Bedroom**  
Ground Floor

WIDTH:4.48 m · LENGTH:3.50 m  
AREA:15.68 m<sup>2</sup> · PERIMETER:15.96 m

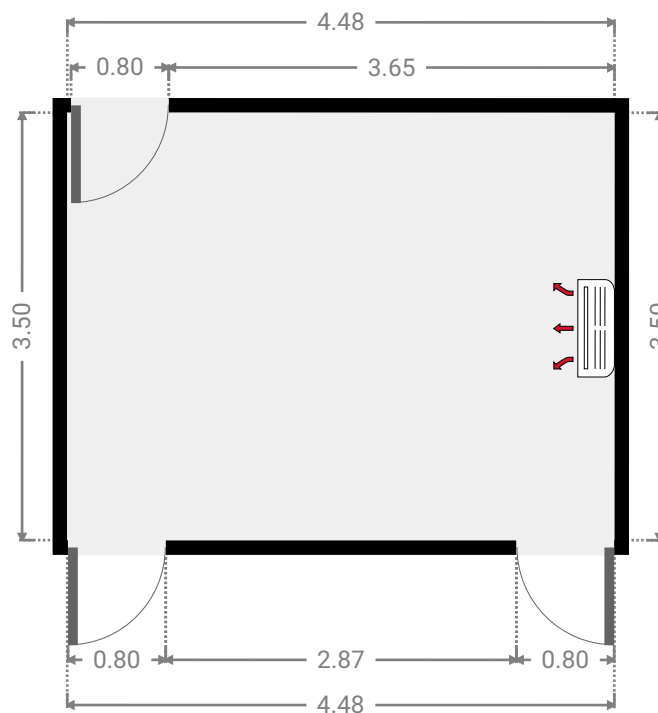
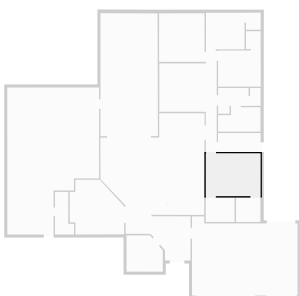

FLOORS:1

## ▼ Living Room Ground Floor

WIDTH:4.72 m · LENGTH:8.30 m  
AREA:22.61 m<sup>2</sup> · PERIMETER:26.03 m

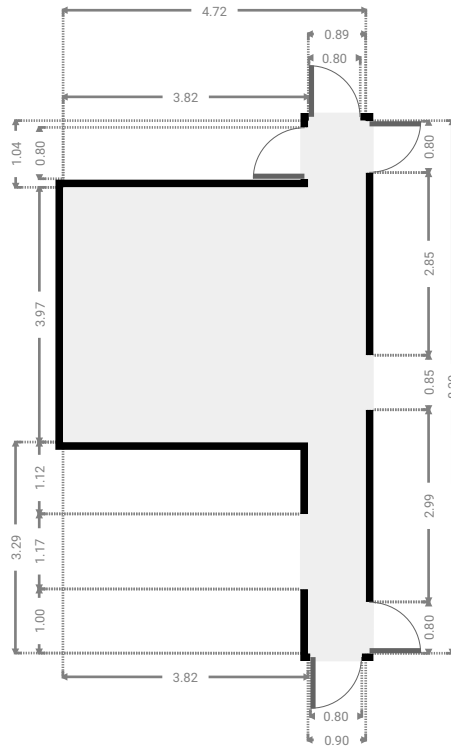
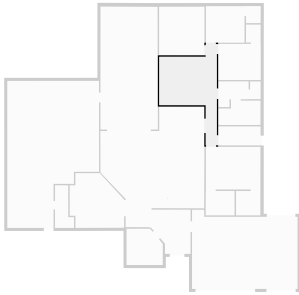

## ▼ Garage Ground Floor

WIDTH:8.67 m · LENGTH:6.50 m  
AREA:51.93 m<sup>2</sup> · PERIMETER:30.34 m

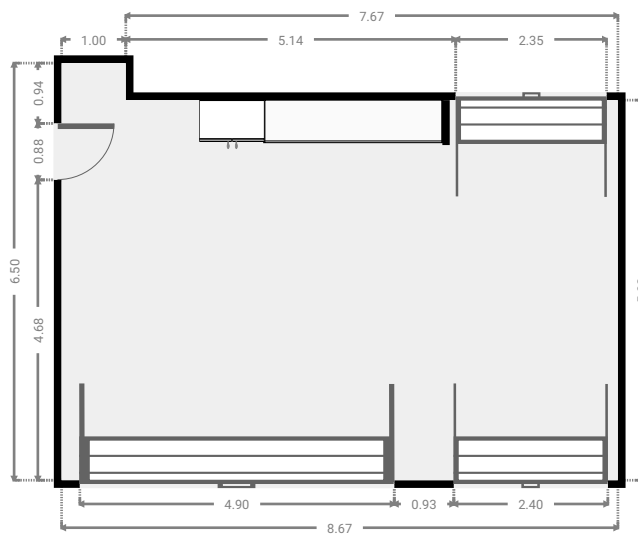
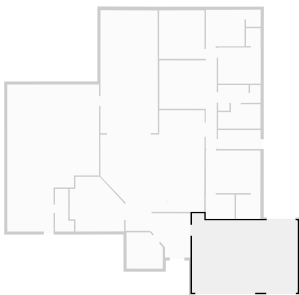

FLOORS:1

▼ **Living Room**  
Ground Floor

WIDTH:4.47 m · LENGTH:4.50 m  
AREA:16.98 m<sup>2</sup> · PERIMETER:16.71 m

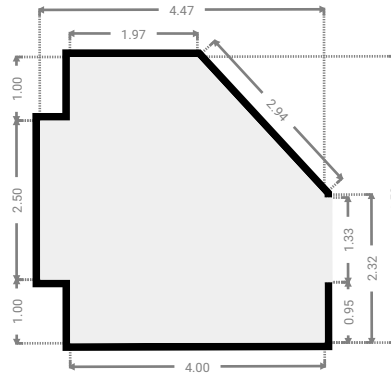
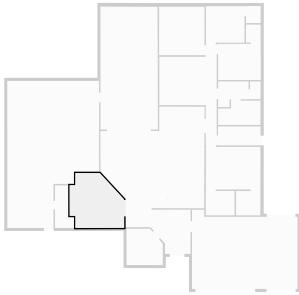

▼ **Kitchen**  
Ground Floor

WIDTH:8.56 m · LENGTH:9.91 m  
AREA:60.94 m<sup>2</sup> · PERIMETER:35.66 m

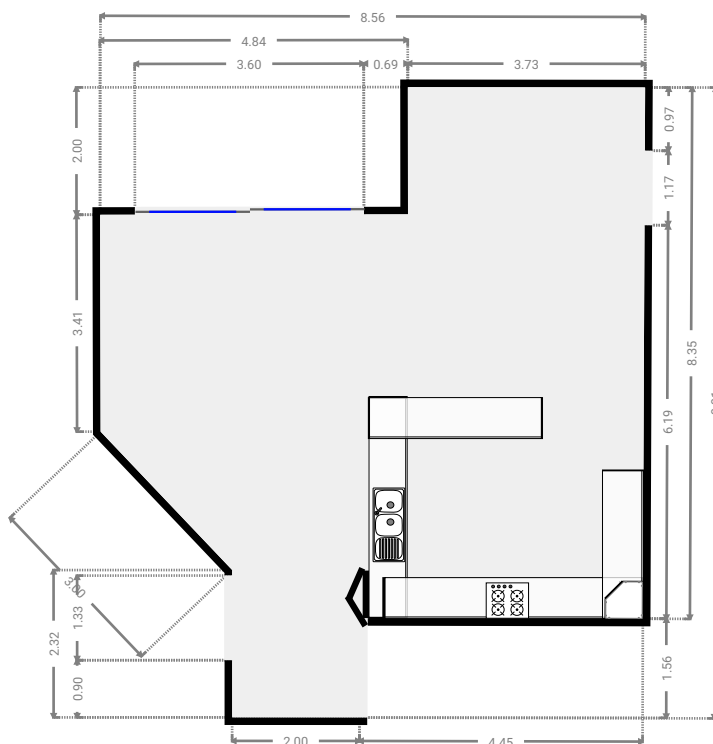
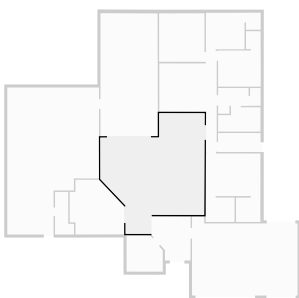

▼ **Study**  
Ground Floor

WIDTH:2.98 m · LENGTH:2.99 m  
AREA:8.22 m<sup>2</sup> · PERIMETER:11.25 m

