

70 Pennyquick Street

Created on
2020-11-16

Floors
2

▼ Ground Floor

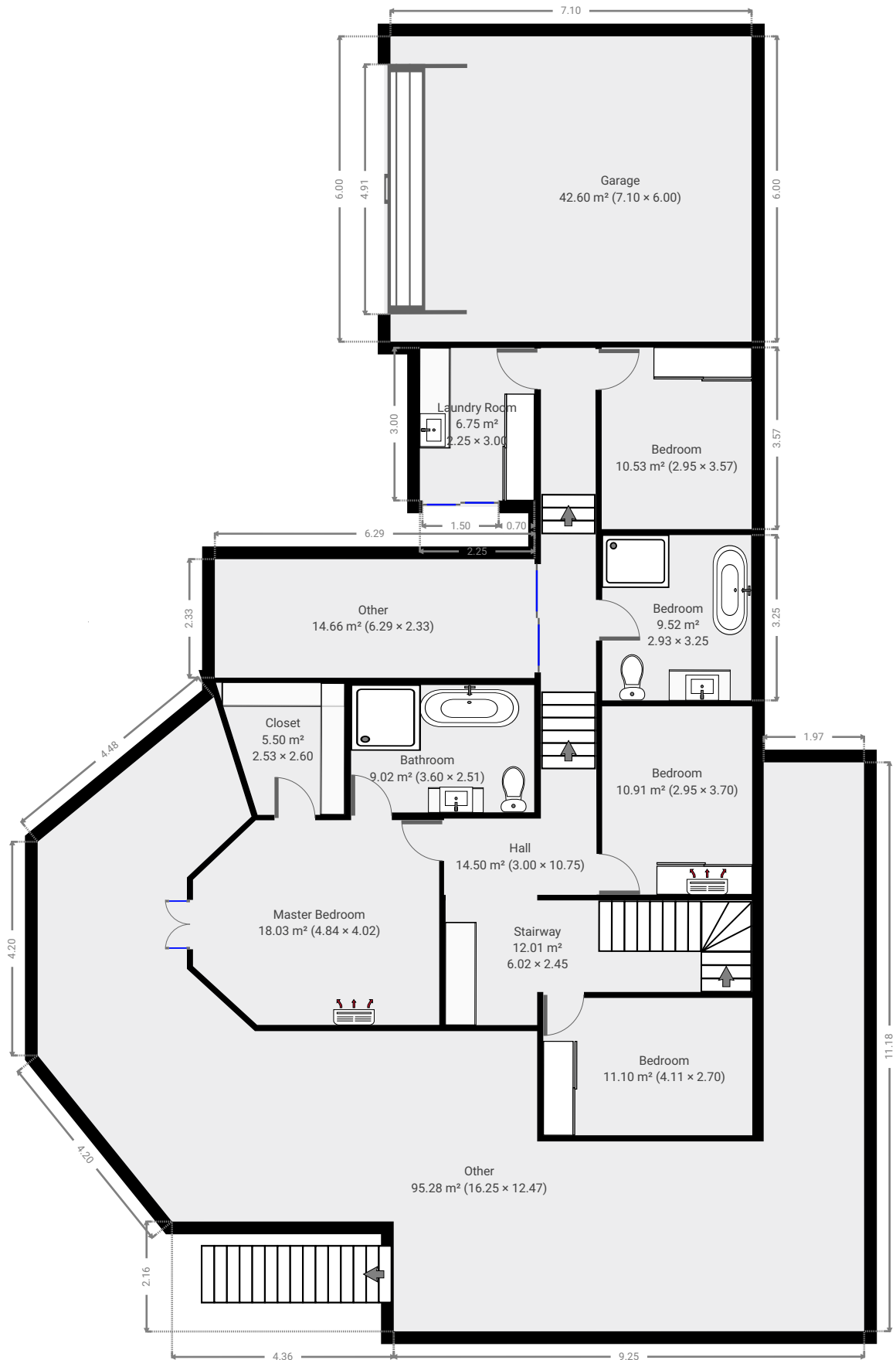

▼ **Stairway**
Ground Floor

WIDTH:2.45 m · LENGTH:6.02 m
AREA:12.01 m² · PERIMETER:16.94 m

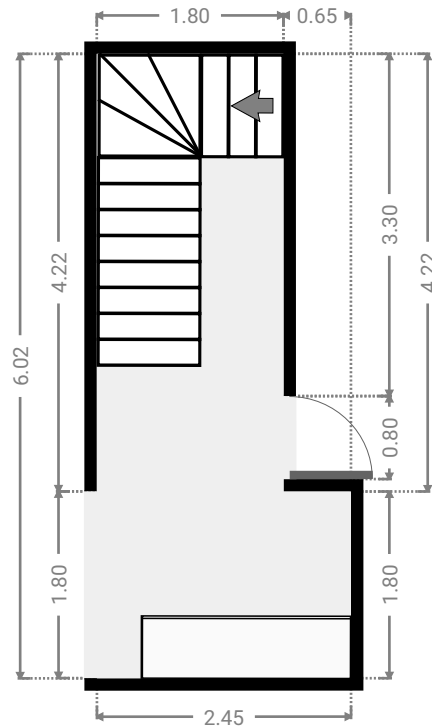
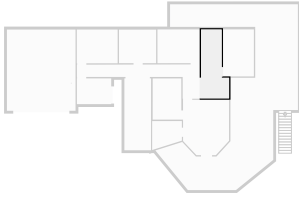

▼ **Bedroom**
Ground Floor

WIDTH:2.70 m · LENGTH:4.11 m
AREA:11.10 m² · PERIMETER:13.62 m

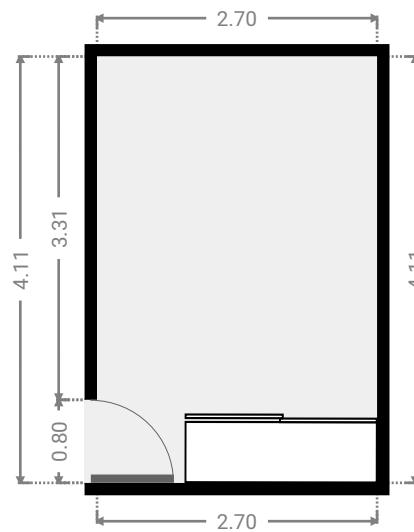
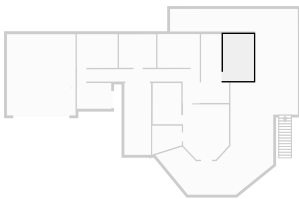

▼ **Hall**
Ground Floor

WIDTH:10.75 m · LENGTH:3.00 m
AREA:14.50 m² · PERIMETER:27.47 m

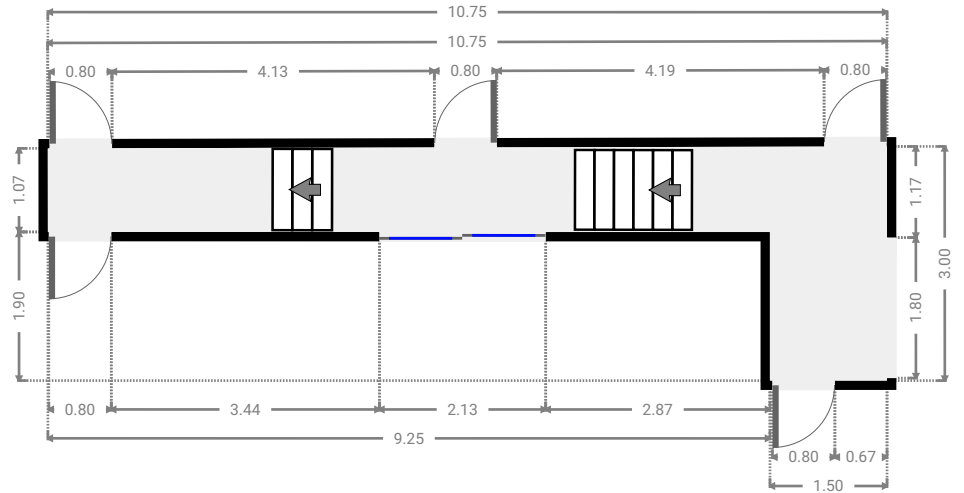
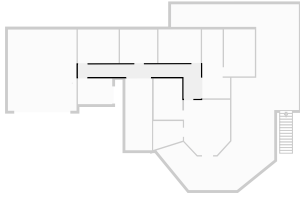

▼ **Master Bedroom**
Ground Floor

WIDTH:4.02 m · LENGTH:4.84 m
AREA:18.03 m² · PERIMETER:16.32 m

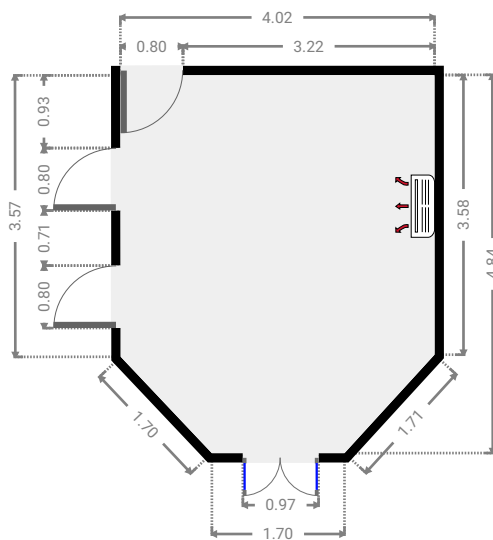
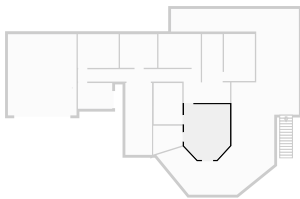

▼ **Bathroom**
Ground Floor

WIDTH:2.51 m · LENGTH:3.60 m
AREA:9.02 m² · PERIMETER:12.21 m

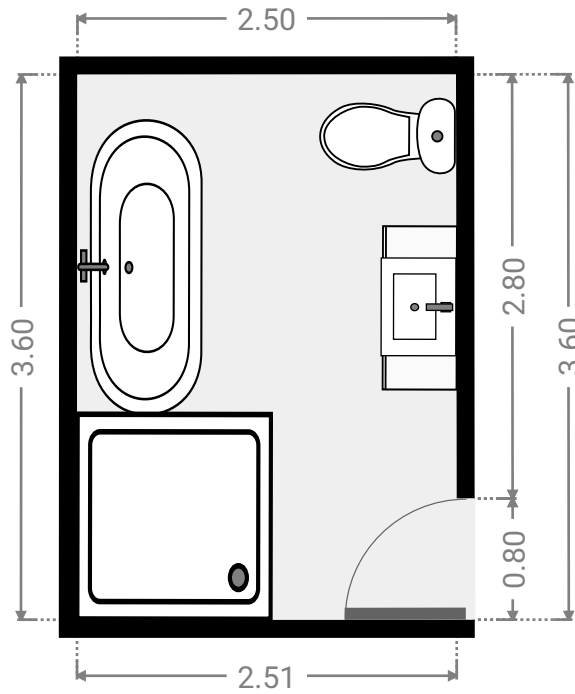
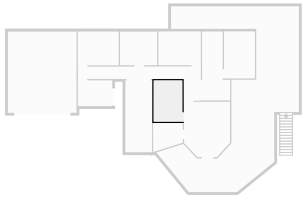

▼ **Closet**
Ground Floor

WIDTH:2.60 m · LENGTH:2.53 m
AREA:5.50 m² · PERIMETER:9.56 m

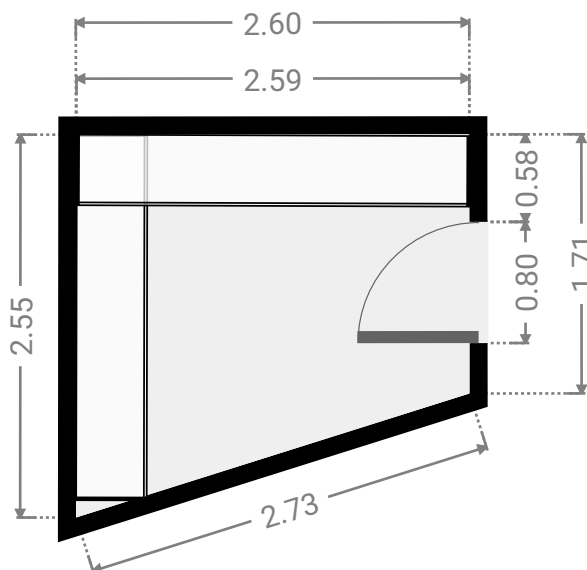
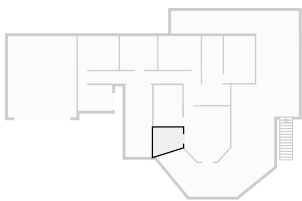

▼ **Bedroom**
Ground Floor

WIDTH:3.70 m · LENGTH:2.95 m
AREA:10.91 m² · PERIMETER:13.30 m

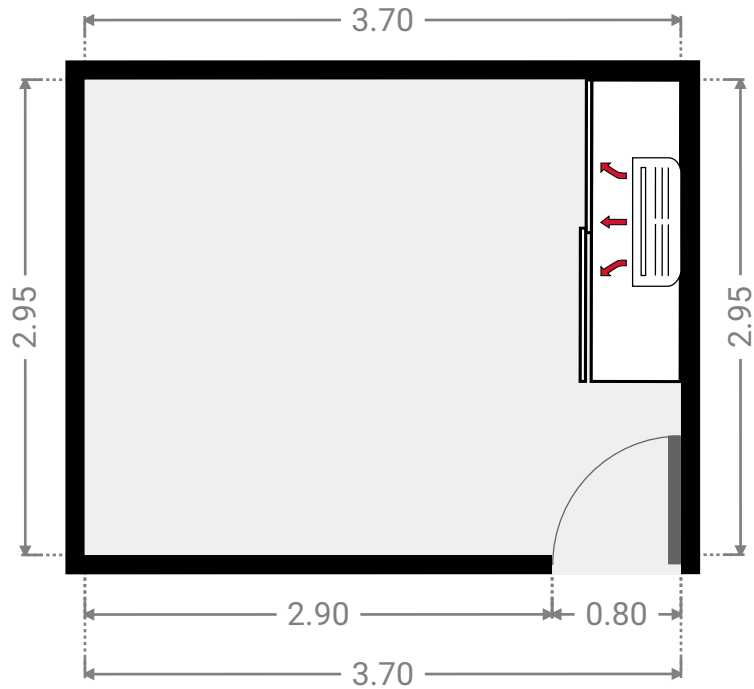
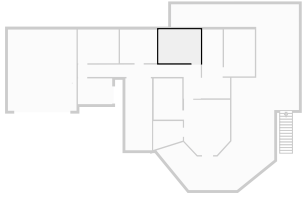

▼ **Bedroom**
Ground Floor

WIDTH:3.25 m · LENGTH:2.93 m
AREA:9.52 m² · PERIMETER:12.36 m

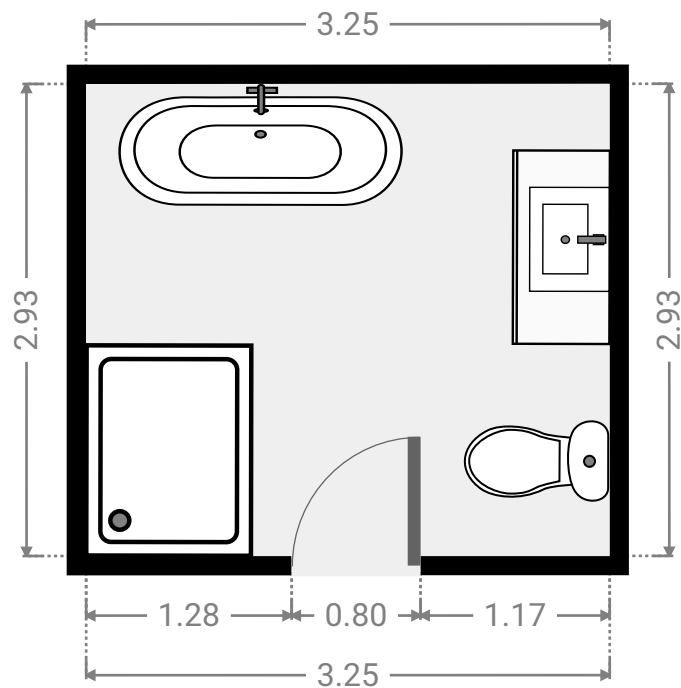
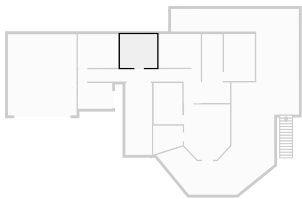

▼ **Bedroom**
Ground Floor

WIDTH:3.57 m · LENGTH:2.95 m
AREA:10.53 m² · PERIMETER:13.04 m

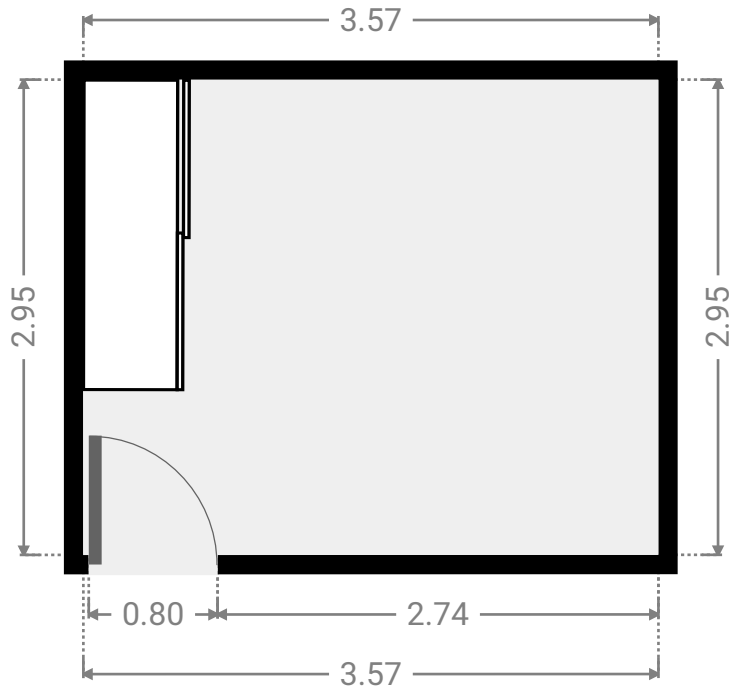
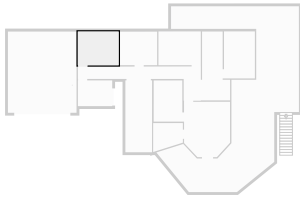

▼ **Laundry Room**
Ground Floor

WIDTH:3.00 m · LENGTH:2.25 m
AREA:6.75 m² · PERIMETER:10.50 m

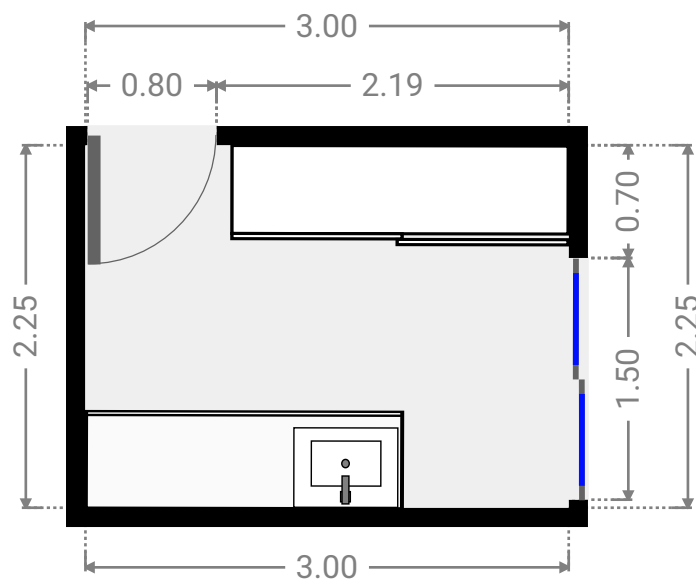
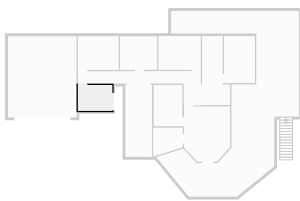

▼ **Garage**
Ground Floor

WIDTH:6.00 m · LENGTH:7.10 m
AREA:42.60 m² · PERIMETER:26.20 m

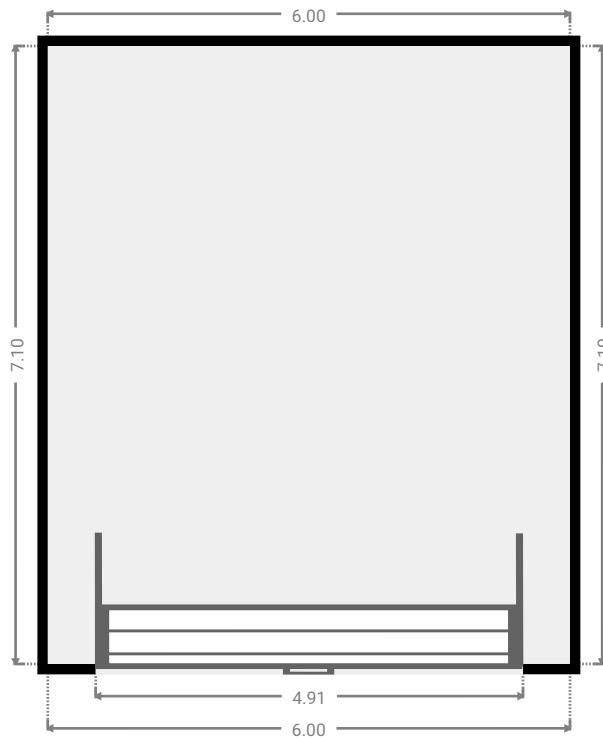
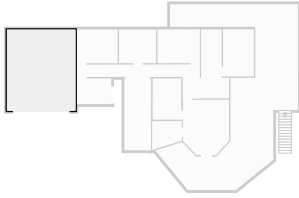

▼ **Other**
Ground Floor

WIDTH:2.33 m · LENGTH:6.29 m
AREA:14.66 m² · PERIMETER:17.24 m

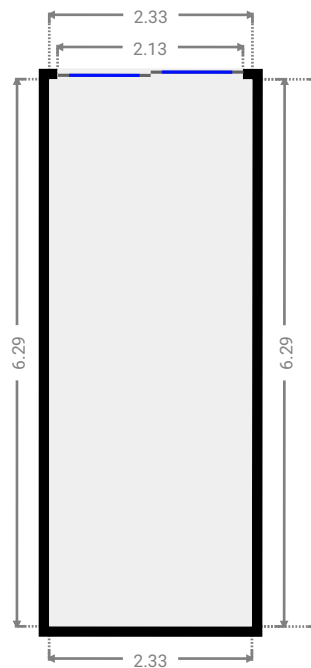
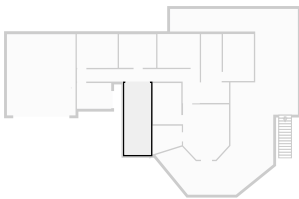

▼ Other
Ground Floor

WIDTH:12.47 m · LENGTH:16.25 m
AREA:95.28 m² · PERIMETER:69.25 m

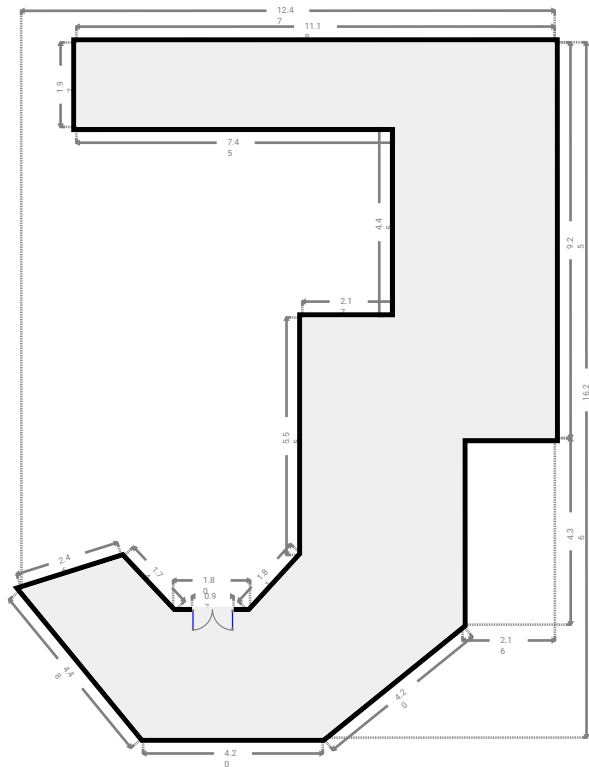
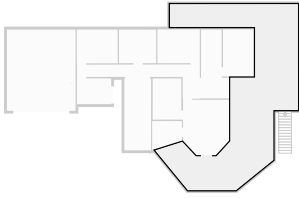

▼ 1st Floor

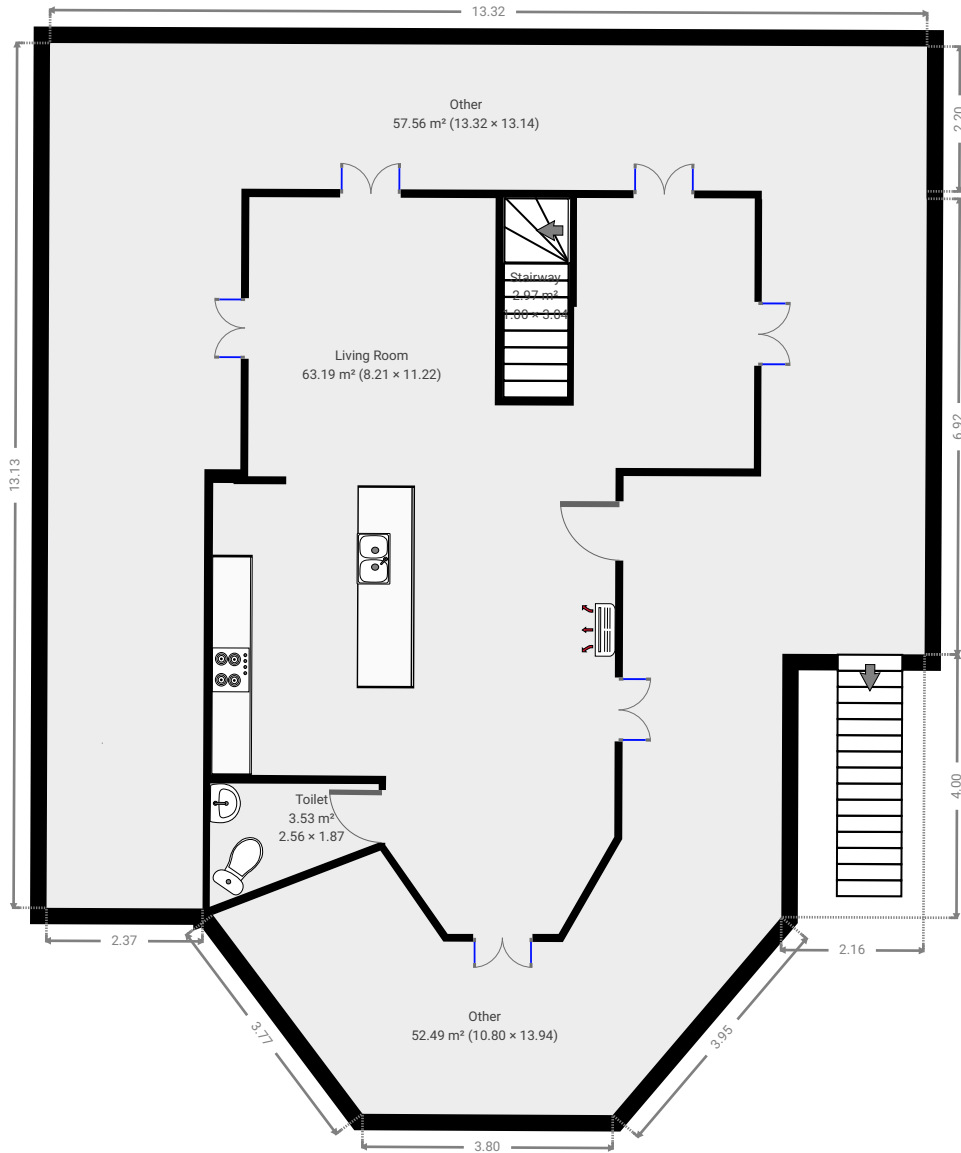

▼ Toilet
1st Floor

WIDTH:2.56 m · LENGTH:1.87 m
AREA:3.53 m² · PERIMETER:8.06 m

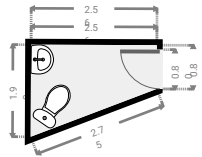
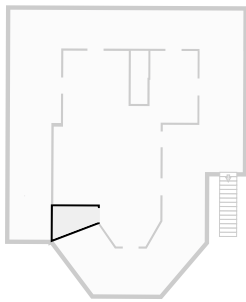

▼ Other
1st Floor

WIDTH:10.80 m · LENGTH:13.94 m
AREA:52.49 m² · PERIMETER:46.97 m

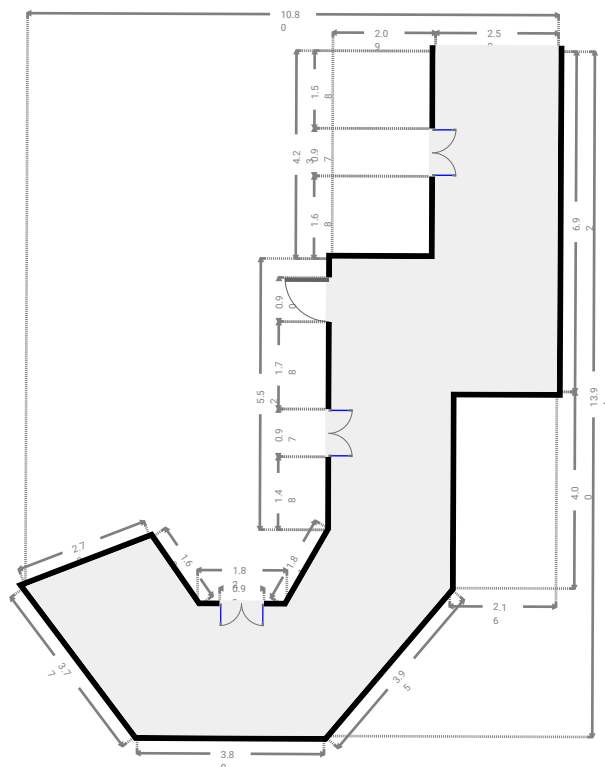
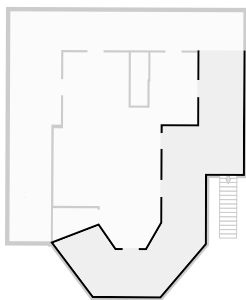

▼ Other
1st Floor

WIDTH:13.32 m · LENGTH:13.14 m
AREA:57.56 m² · PERIMETER:52.91 m

