

# 70 Jessie Street

## Ground Floor

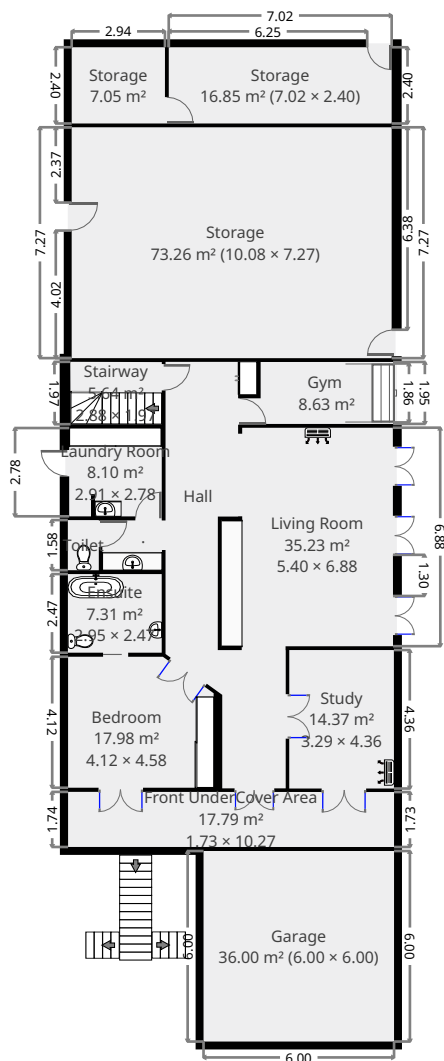

THIS FLOORPLAN IS PROVIDED WITHOUT WARRANTY OF ANY KIND. SENSOPIA DISCLAIMS ANY WARRANTY INCLUDING, WITHOUT LIMITATION, SATISFACTORY QUALITY OR ACCURACY OF DIMENSIONS.

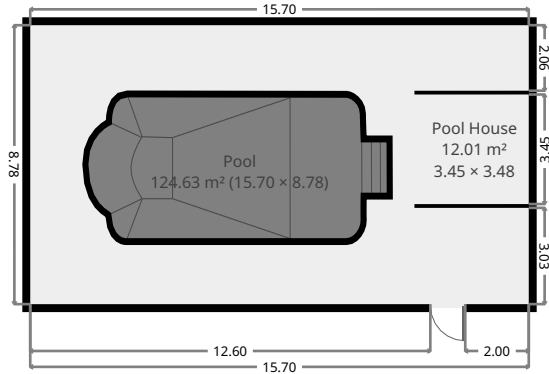

# 70 Jessie Street

## Stairway

Width:	1.97 m
Length:	2.88 m
Area	5.64 m <sup>2</sup>
Perimeter	9.68 m

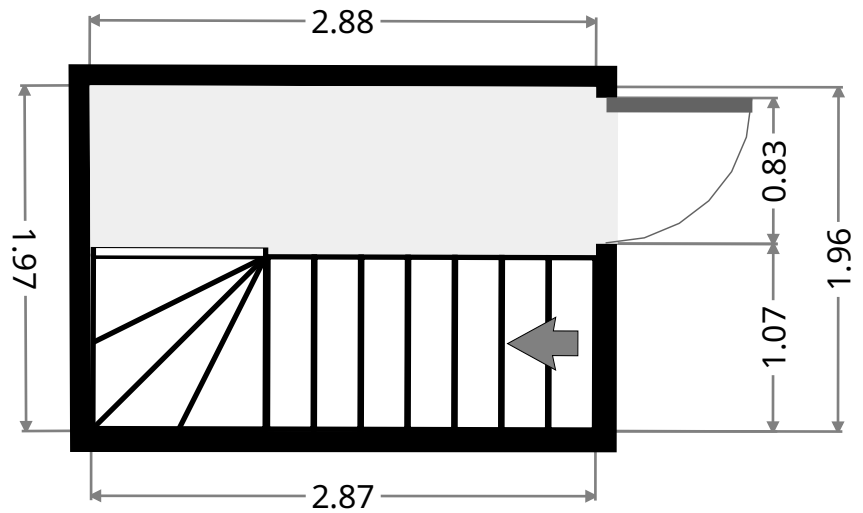
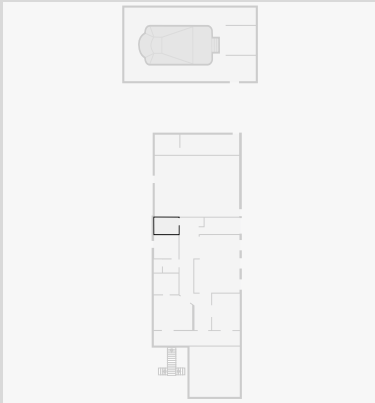

## Pool House

Width:	3.45 m
Length:	3.48 m
Area	12.01 m <sup>2</sup>
Perimeter	13.86 m

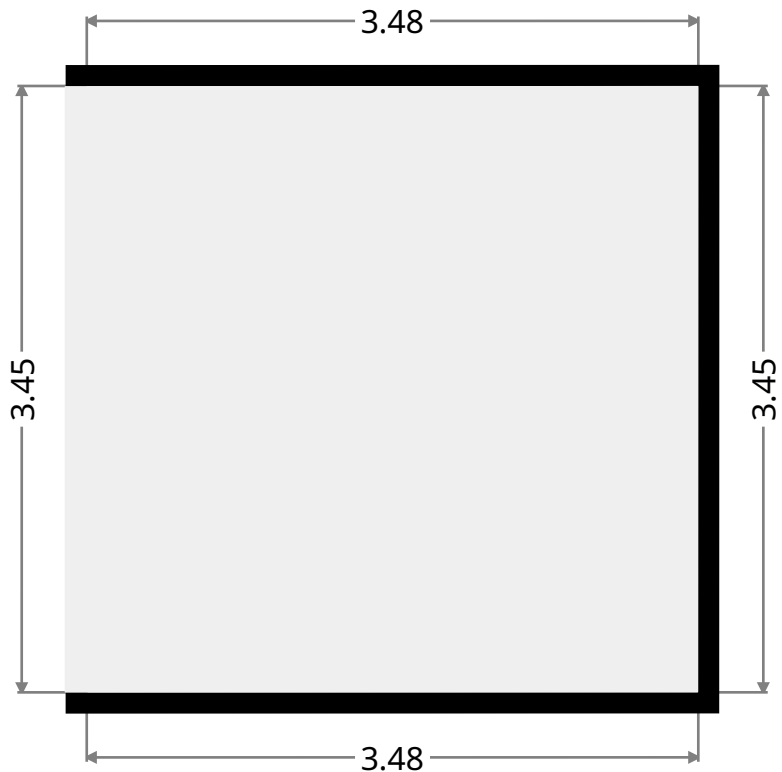
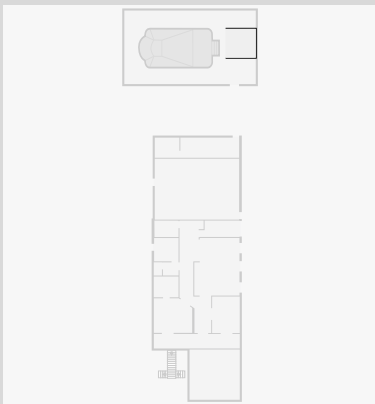

# 70 Jessie Street

## Pool

Width: 8.78 m  
Length: 15.70 m  
Area: 124.63 m<sup>2</sup>  
Perimeter: 56.17 m

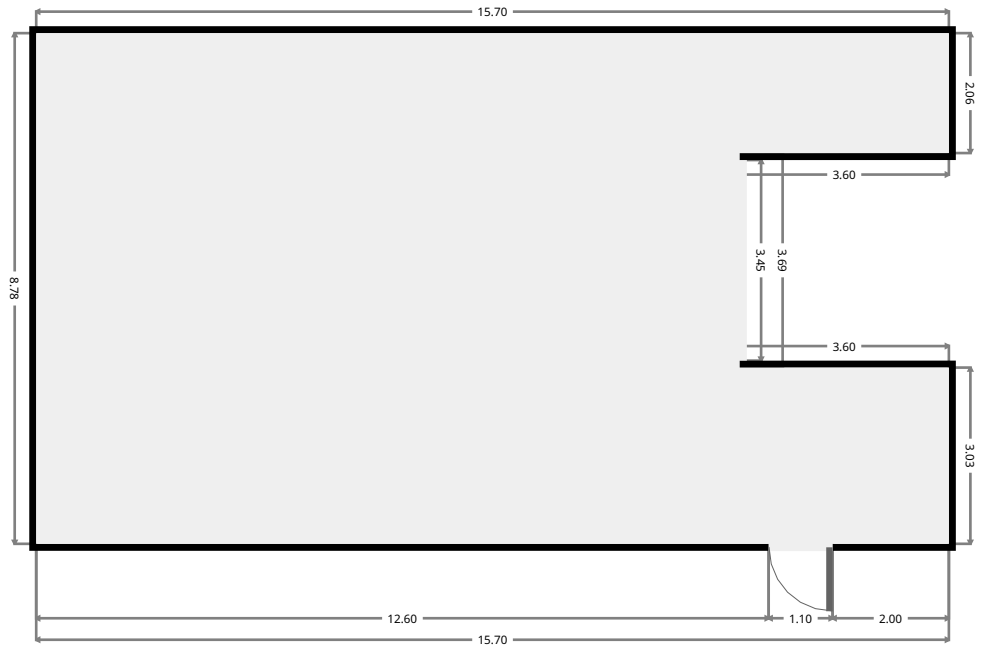
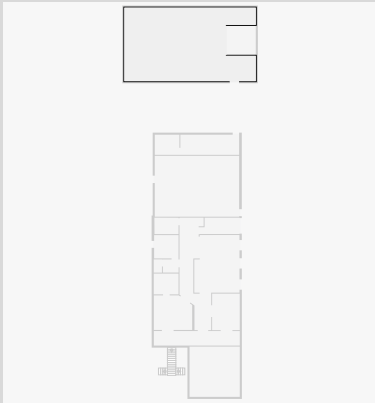

# 70 Jessie Street

## Storage

Width: 2.40 m  
 Length: 2.94 m  
 Area: 7.05 m<sup>2</sup>  
 Perimeter: 10.67 m

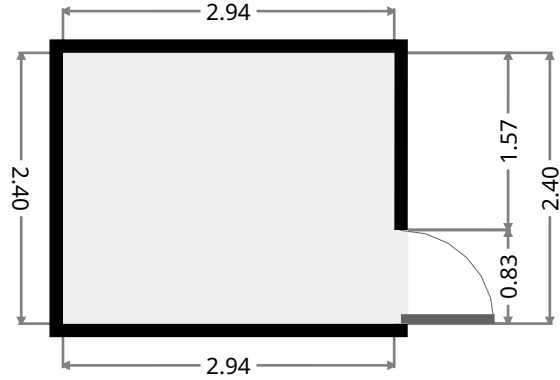
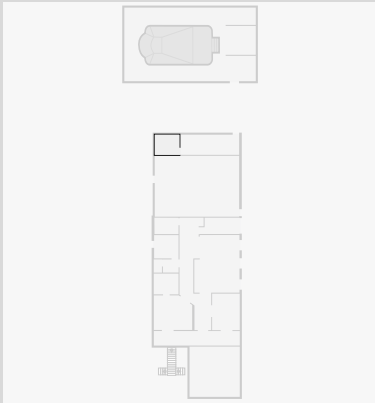

## Storage

Width: 2.40 m  
 Length: 7.02 m  
 Area: 16.85 m<sup>2</sup>  
 Perimeter: 18.84 m

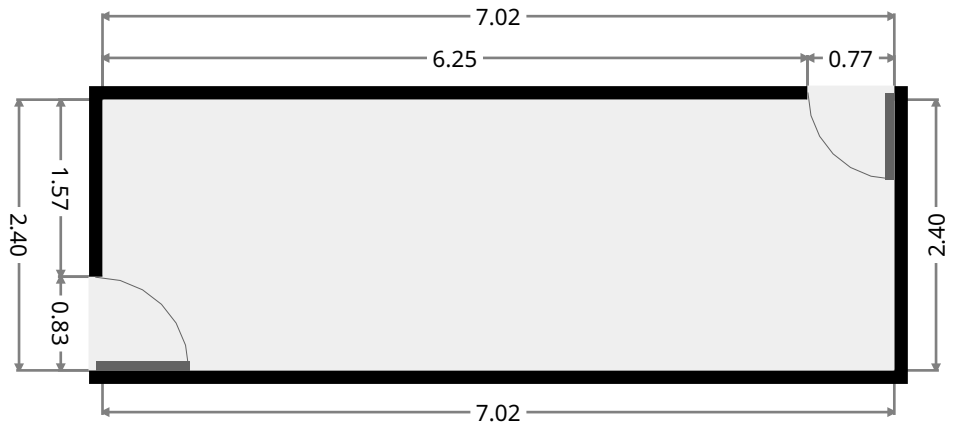
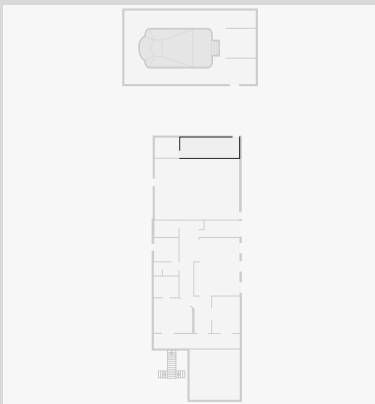

# 70 Jessie Street

## Storage

Width: 7.27 m  
Length: 10.08 m  
Area: 73.26 m<sup>2</sup>  
Perimeter: 34.69 m

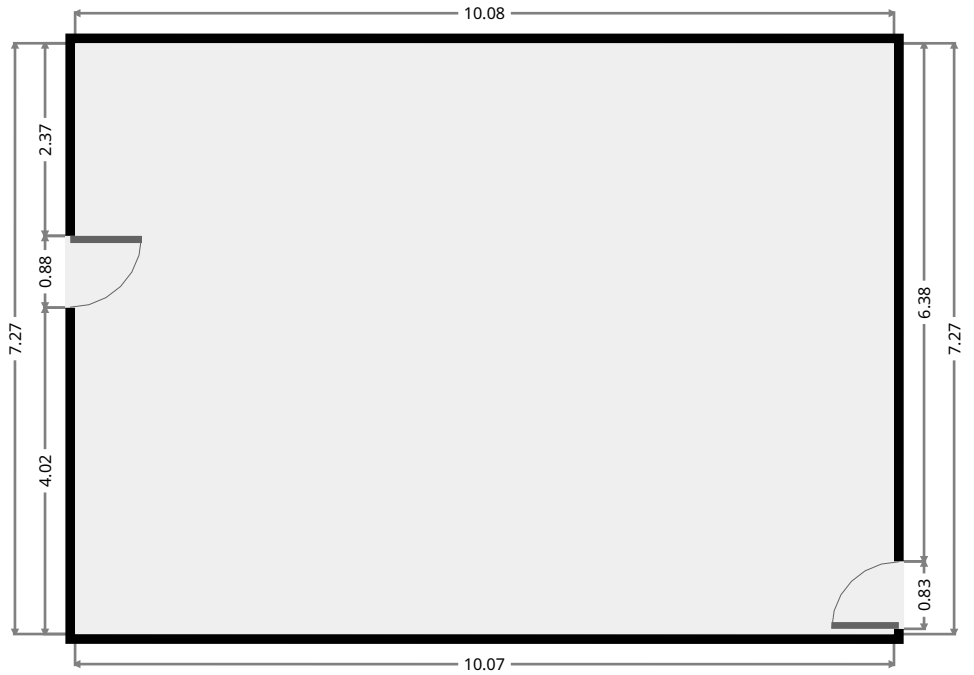
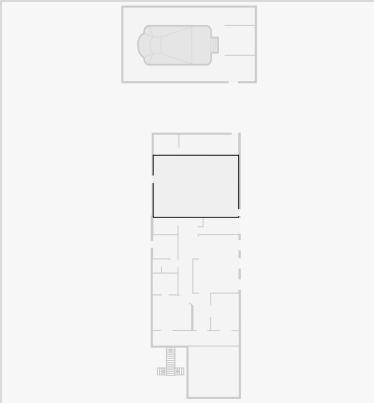

# 70 Jessie Street

## Garage

Width: 6.00 m  
Length: 6.00 m  
Area: 36.00 m<sup>2</sup>  
Perimeter: 24.00 m

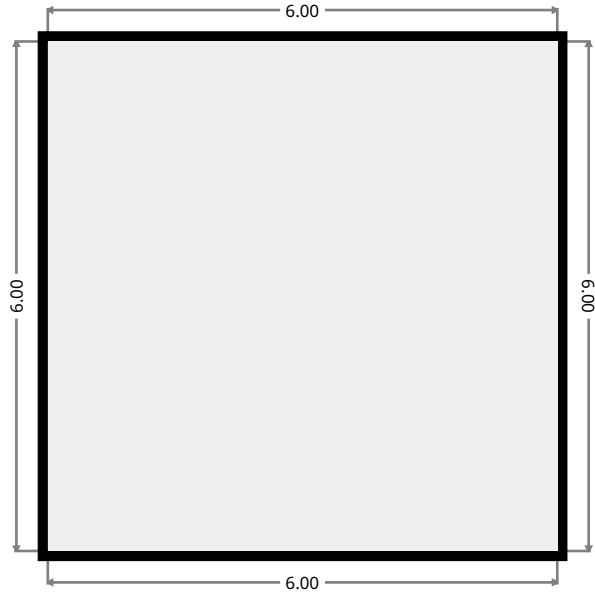
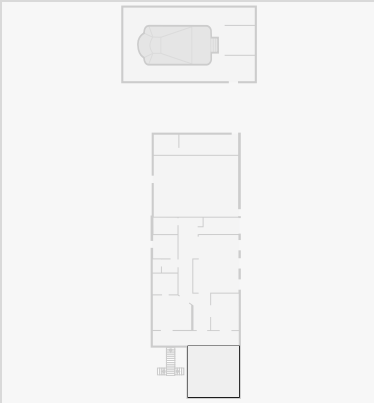

## Front UnderCover Area

Width: 1.73 m  
Length: 10.27 m  
Area: 17.79 m<sup>2</sup>  
Perimeter: 24.00 m

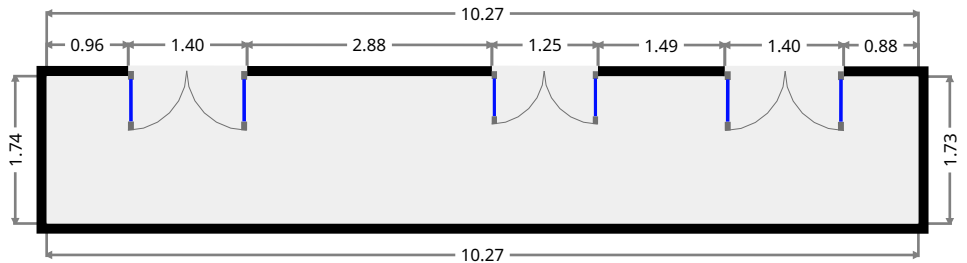
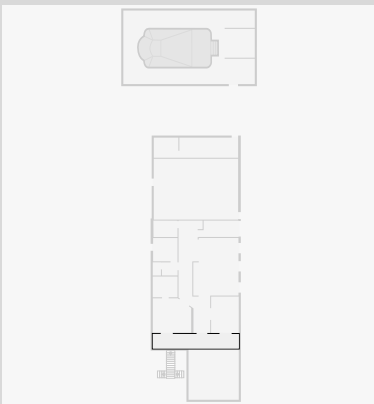

# 70 Jessie Street

## Gym

Width: 1.95 m  
 Length: 4.78 m  
 Area: 8.63 m<sup>2</sup>  
 Perimeter: 13.45 m

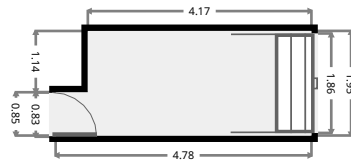
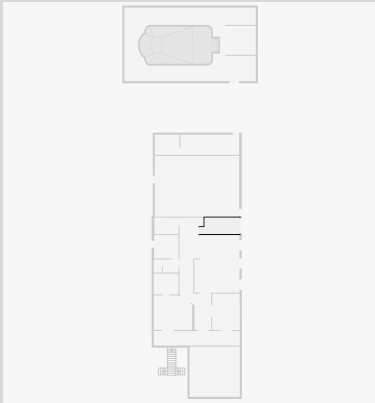

## Hall

Width: 3.79 m  
 Length: 13.43 m  
 Area: 28.74 m<sup>2</sup>  
 Perimeter: 36.03 m

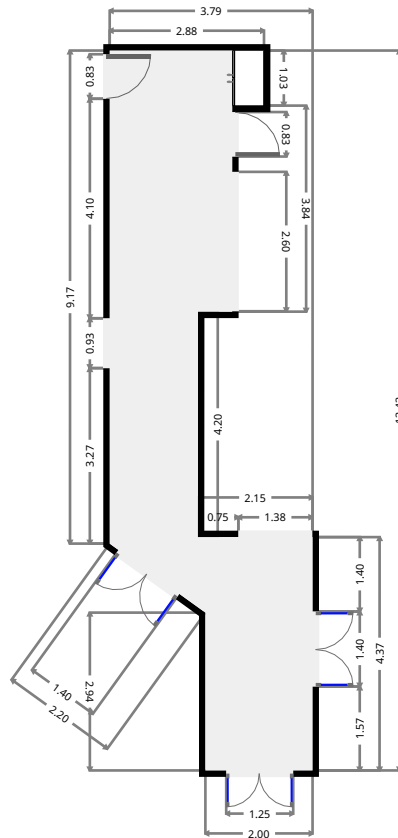
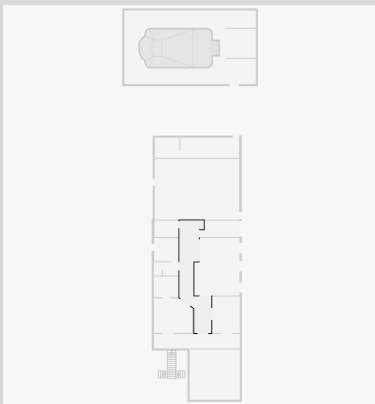

THIS FLOORPLAN IS PROVIDED WITHOUT WARRANTY OF ANY KIND. SENSOPIA DISCLAIMS ANY WARRANTY INCLUDING, WITHOUT LIMITATION, SATISFACTORY QUALITY OR ACCURACY OF DIMENSIONS.

# 70 Jessie Street

## Laundry Room

Width: 2.78 m  
 Length: 2.91 m  
 Area: 8.10 m<sup>2</sup>  
 Perimeter: 11.39 m

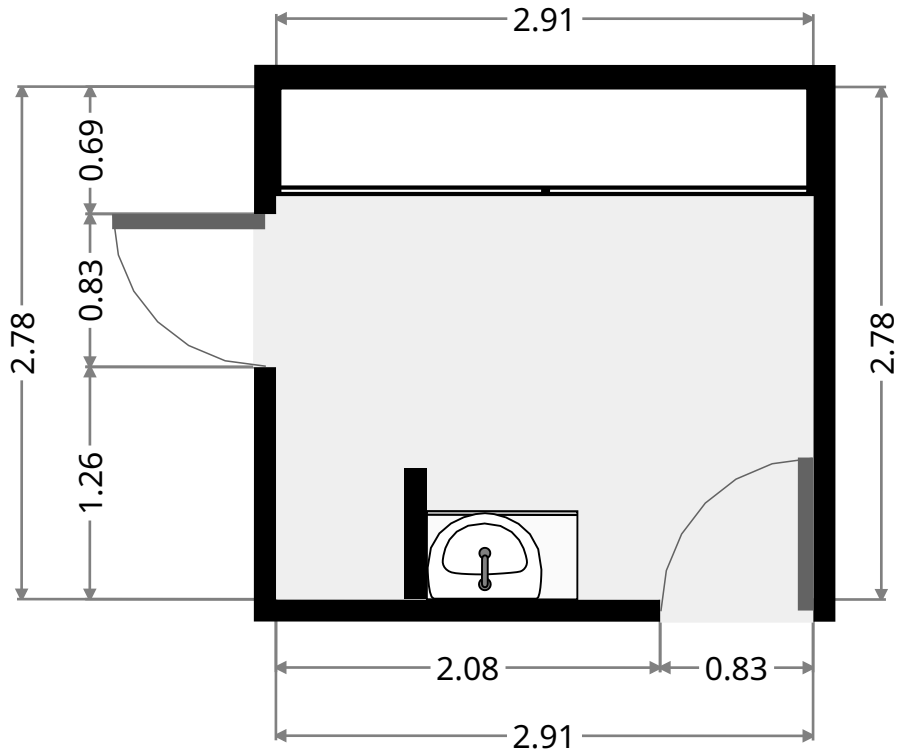
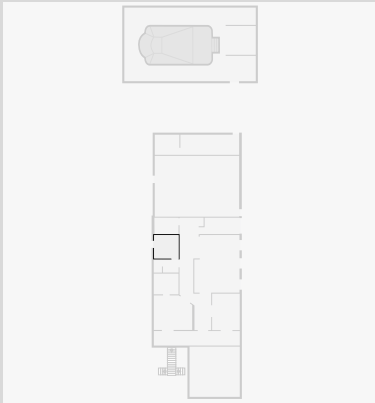

## Toilet / Half Bath

Width: 0.97 m  
 Length: 1.58 m  
 Area: 1.54 m<sup>2</sup>  
 Perimeter: 5.11 m

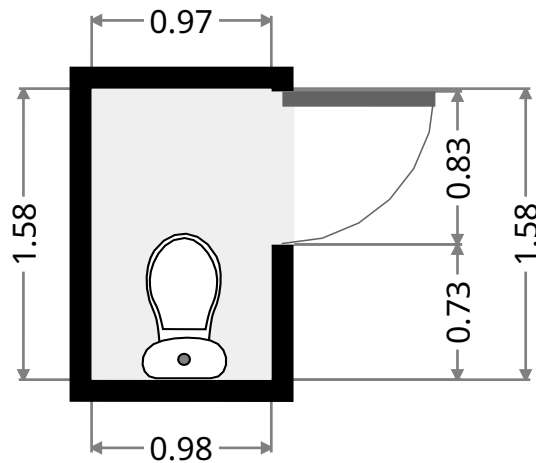
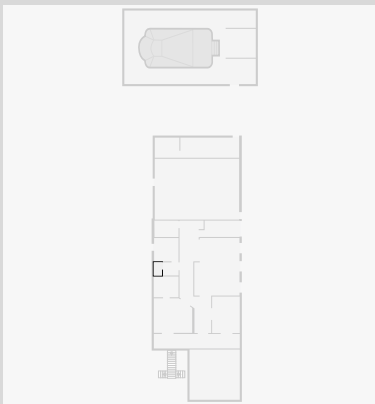



# 70 Jessie Street

•  
 Width: 1.56 m  
 Length: 1.88 m  
 Area: 2.93 m<sup>2</sup>  
 Perimeter: 6.88 m

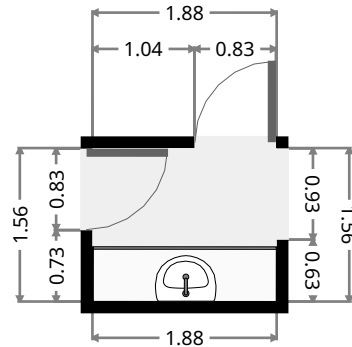

## Living Room

Width: 5.40 m  
 Length: 6.88 m  
 Area: 35.23 m<sup>2</sup>  
 Perimeter: 24.55 m

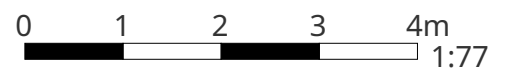
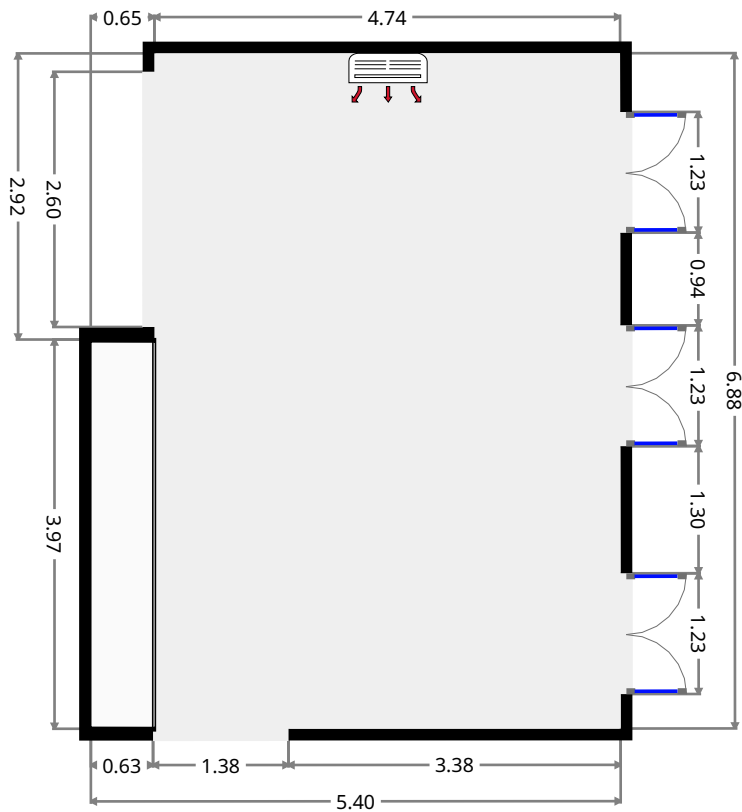
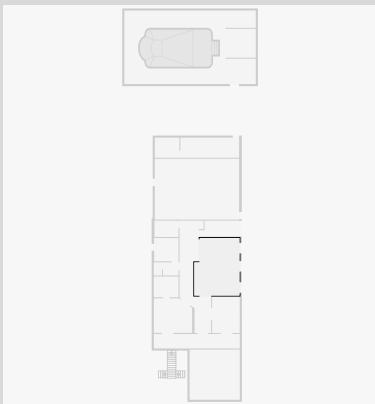

THIS FLOORPLAN IS PROVIDED WITHOUT WARRANTY OF ANY KIND. SENSOPIA DISCLAIMS ANY WARRANTY INCLUDING, WITHOUT LIMITATION, SATISFACTORY QUALITY OR ACCURACY OF DIMENSIONS.

# 70 Jessie Street

## Study

Width: 3.29 m  
 Length: 4.36 m  
 Area: 14.37 m<sup>2</sup>  
 Perimeter: 15.31 m

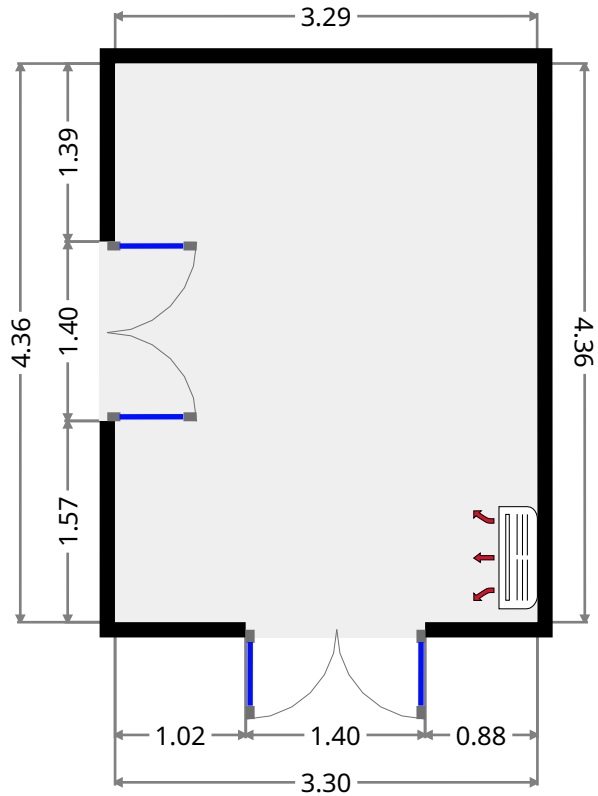
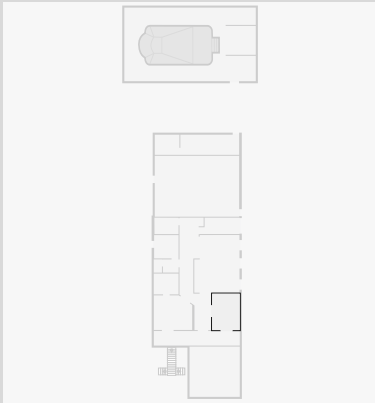

## Ensuite

Width: 2.47 m  
 Length: 2.95 m  
 Area: 7.31 m<sup>2</sup>  
 Perimeter: 10.86 m

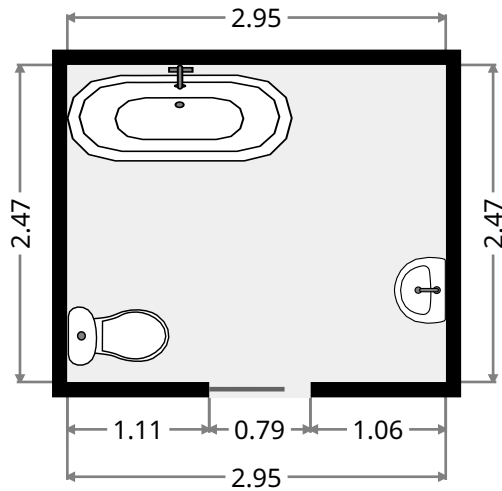

# 70 Jessie Street

## Bedroom

Width: 4.12 m  
Length: 4.58 m  
Area: 17.98 m<sup>2</sup>  
Perimeter: 16.63 m

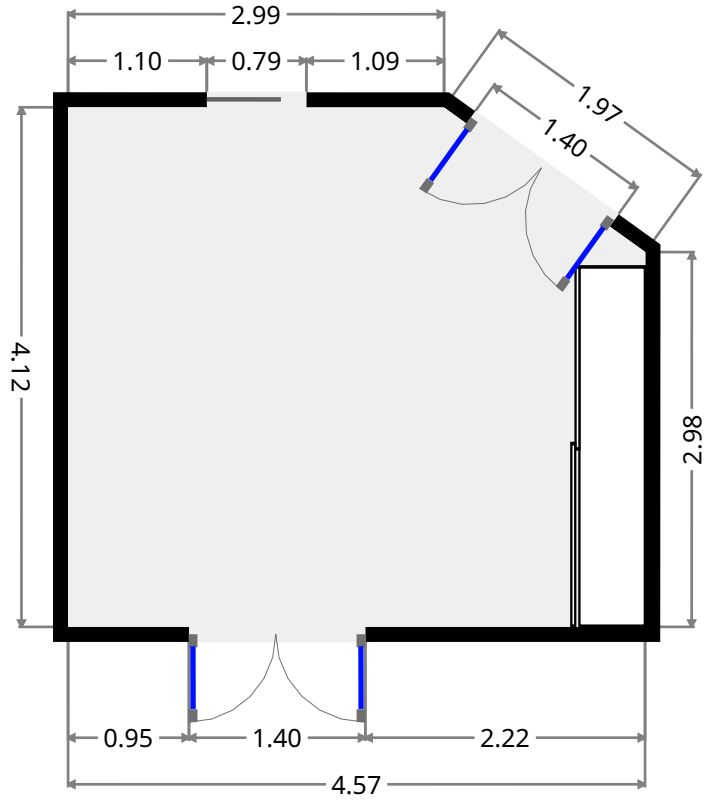
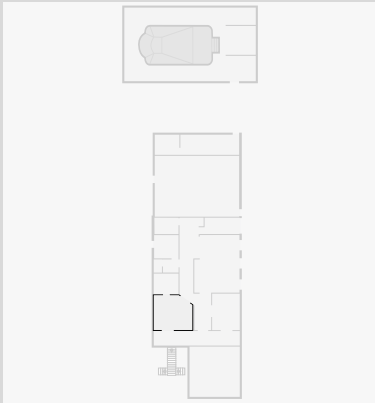

# 70 Jessie Street

## 1st Floor

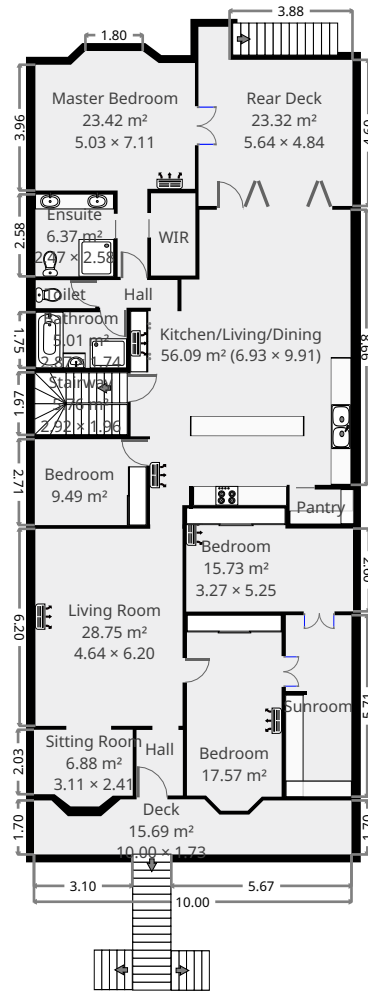

THIS FLOORPLAN IS PROVIDED WITHOUT WARRANTY OF ANY KIND. SENSOPIA DISCLAIMS ANY WARRANTY INCLUDING, WITHOUT LIMITATION, SATISFACTORY QUALITY OR ACCURACY OF DIMENSIONS.



# 70 Jessie Street

## Stairway

Width: 1.96 m  
 Length: 2.92 m  
 Area: 5.76 m<sup>2</sup>  
 Perimeter: 9.79 m

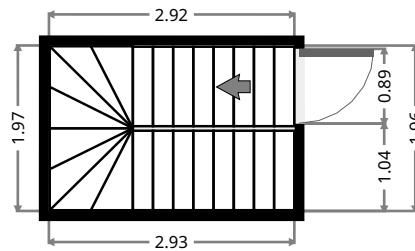
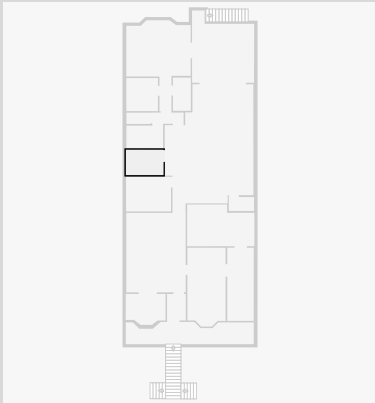

## Deck

Width: 1.73 m  
 Length: 10.00 m  
 Area: 15.69 m<sup>2</sup>  
 Perimeter: 24.18 m

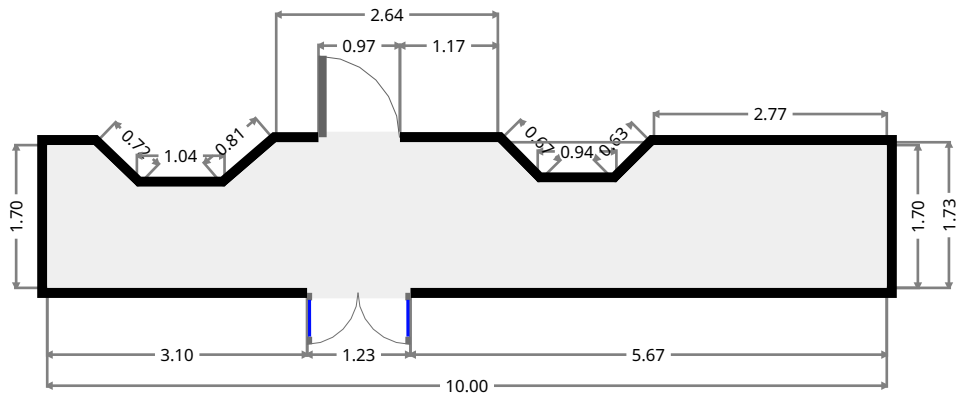
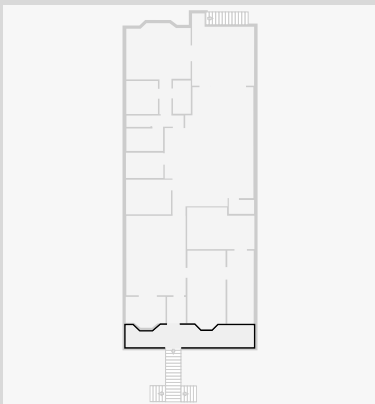

# 70 Jessie Street

## Rear Deck

Width: 4.84 m  
 Length: 5.64 m  
 Area: 23.32 m<sup>2</sup>  
 Perimeter: 20.97 m

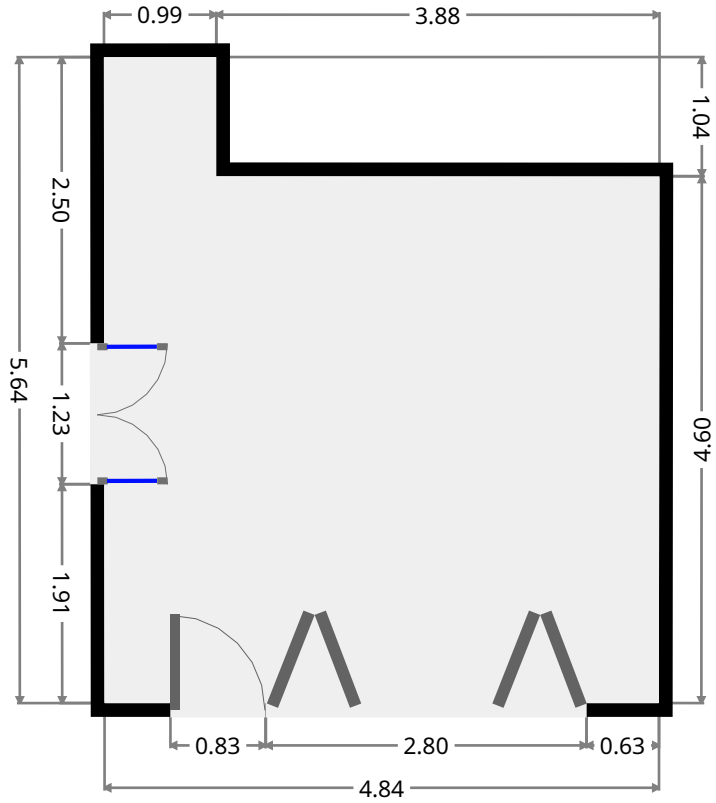
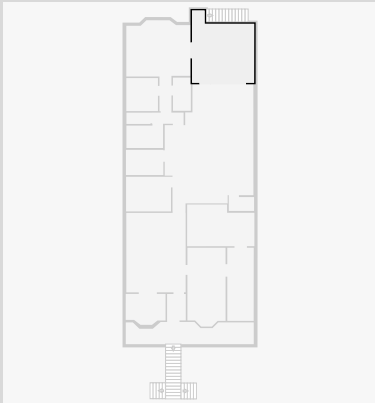

## WIR

Width: 1.40 m  
 Length: 2.58 m  
 Area: 3.62 m<sup>2</sup>  
 Perimeter: 7.97 m

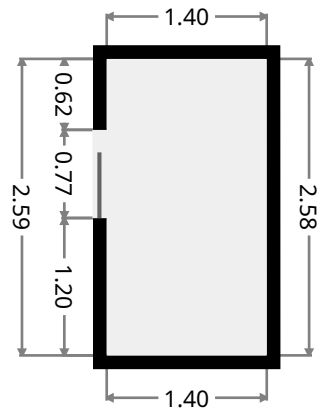
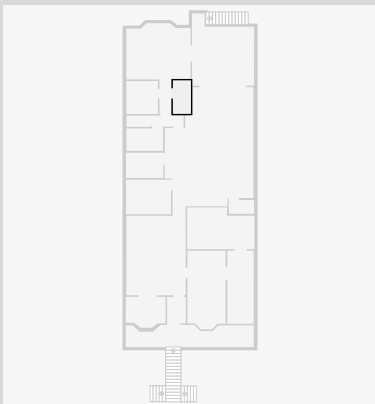

# 70 Jessie Street

## Master Bedroom

Width: 5.03 m  
 Length: 7.11 m  
 Area: 23.42 m<sup>2</sup>  
 Perimeter: 23.76 m

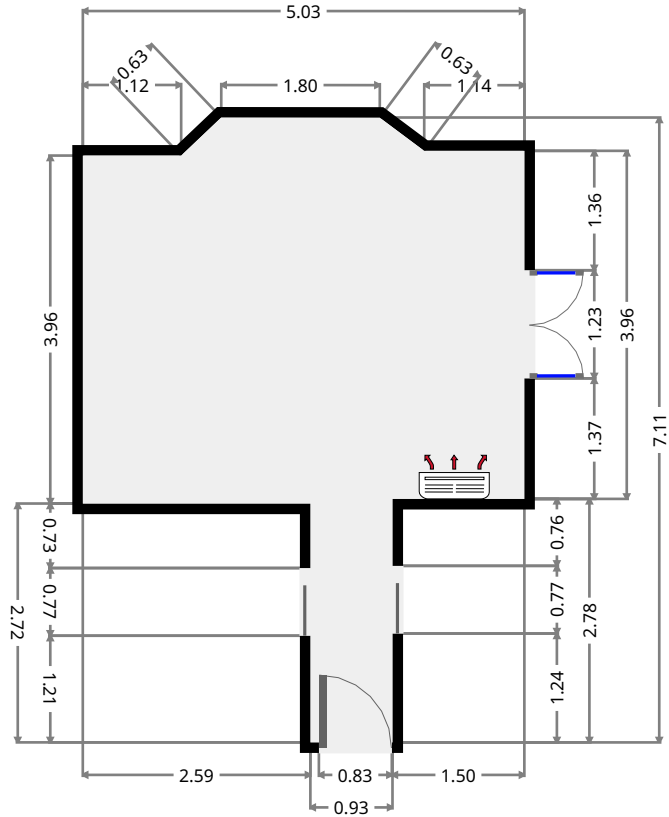
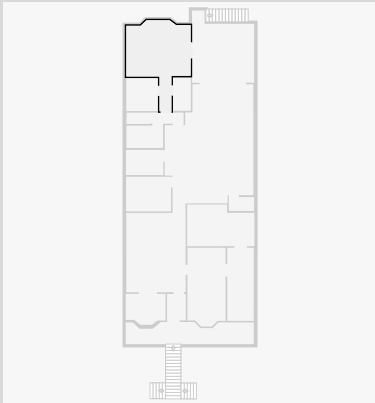

## Ensuite

Width: 2.47 m  
 Length: 2.58 m  
 Area: 6.37 m<sup>2</sup>  
 Perimeter: 10.10 m

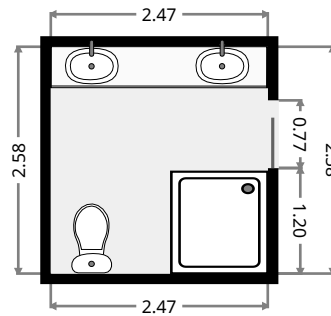
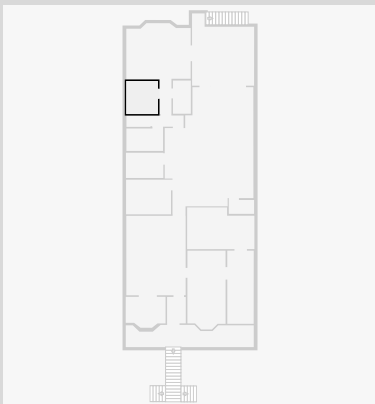

# 70 Jessie Street

## Toilet / Half Bath

Width: 0.88 m  
Length: 1.87 m  
Area: 1.65 m<sup>2</sup>  
Perimeter: 5.51 m

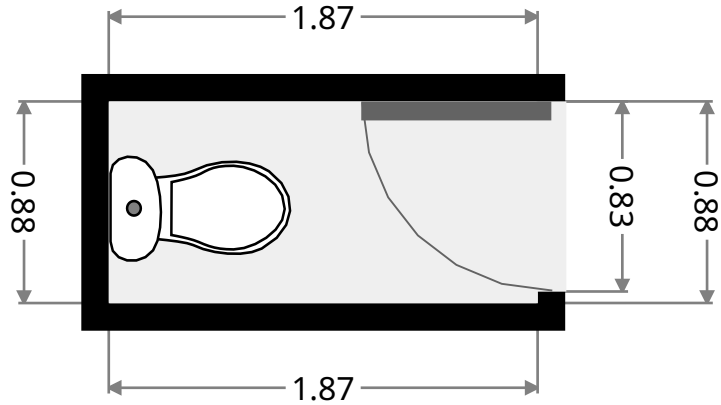
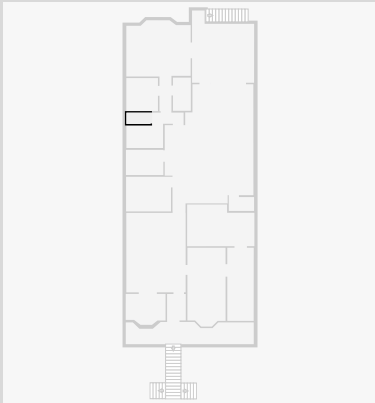

## Bathroom

Width: 1.74 m  
Length: 2.87 m  
Area: 5.01 m<sup>2</sup>  
Perimeter: 9.23 m

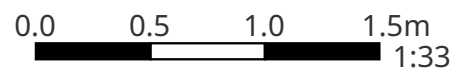
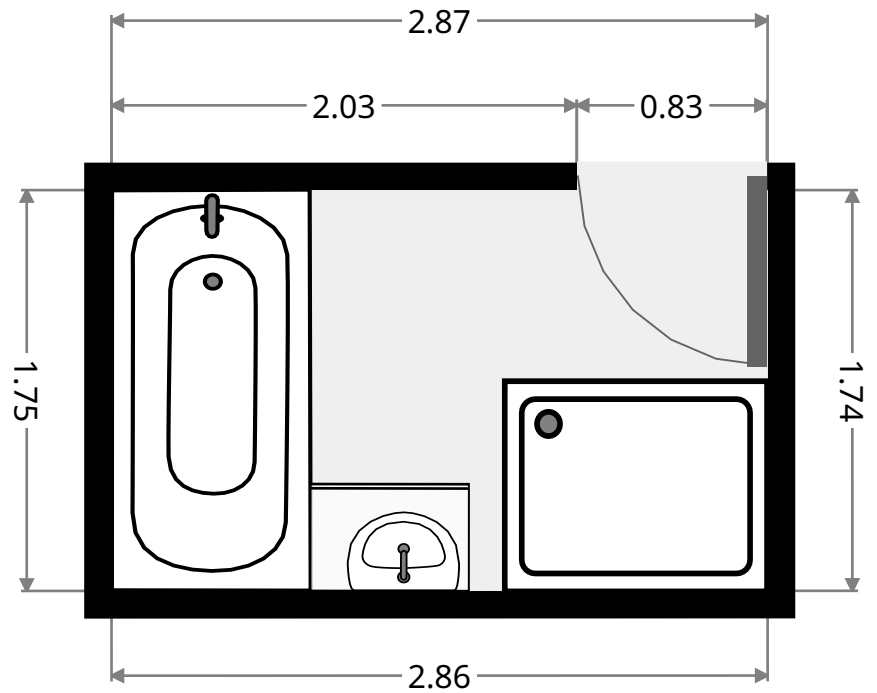
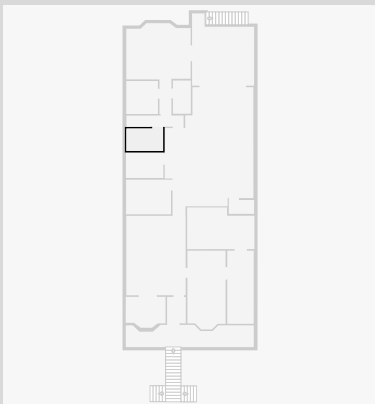

THIS FLOORPLAN IS PROVIDED WITHOUT WARRANTY OF ANY KIND. SENSOPIA DISCLAIMS ANY WARRANTY INCLUDING, WITHOUT LIMITATION, SATISFACTORY QUALITY OR ACCURACY OF DIMENSIONS.



# 70 Jessie Street

## Hall

Width: 0.87 m  
 Length: 2.46 m  
 Area: 2.15 m<sup>2</sup>  
 Perimeter: 6.67 m

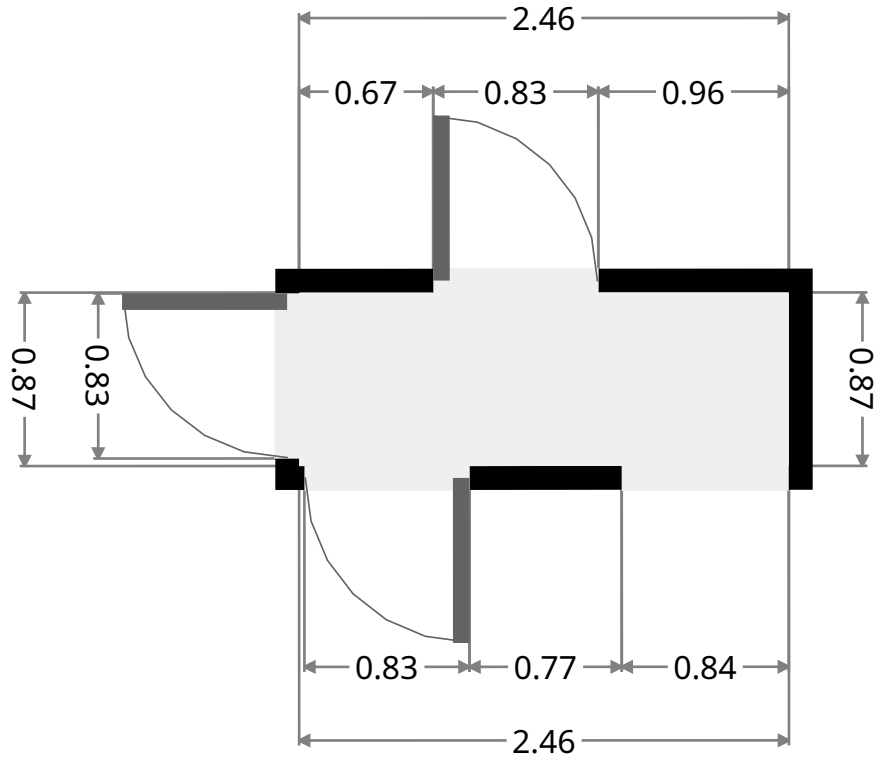
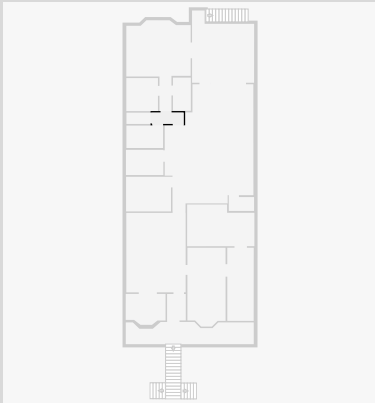

## Hall

Width: 1.46 m  
 Length: 2.06 m  
 Area: 3.01 m<sup>2</sup>  
 Perimeter: 7.05 m

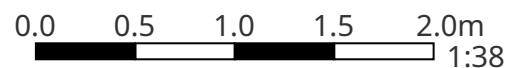
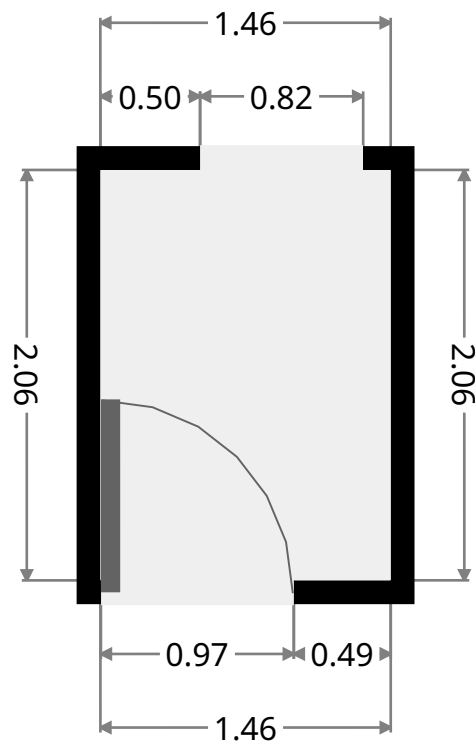
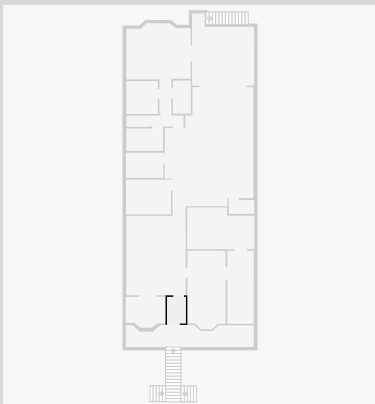

# 70 Jessie Street

## Bedroom

Width: 2.71 m  
 Length: 3.51 m  
 Area: 9.49 m<sup>2</sup>  
 Perimeter: 12.43 m

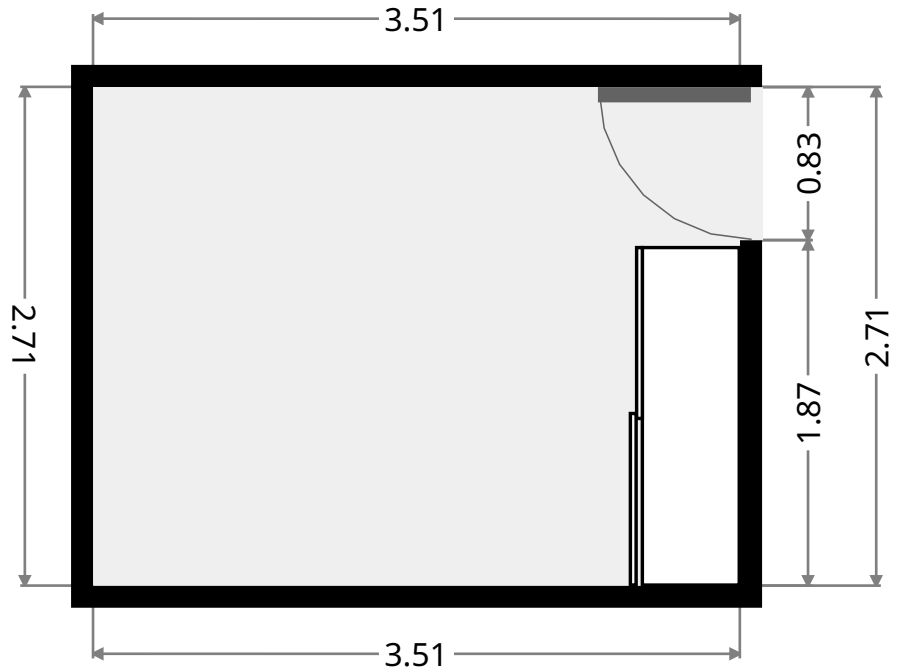
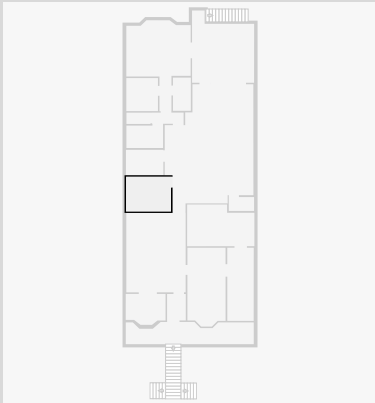

## Pantry

Width: 1.07 m  
 Length: 1.98 m  
 Area: 2.13 m<sup>2</sup>  
 Perimeter: 6.11 m

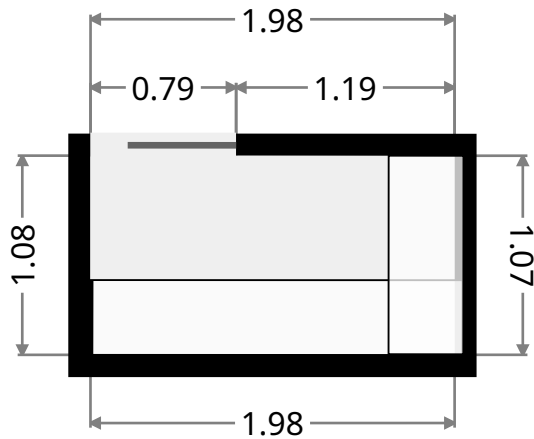
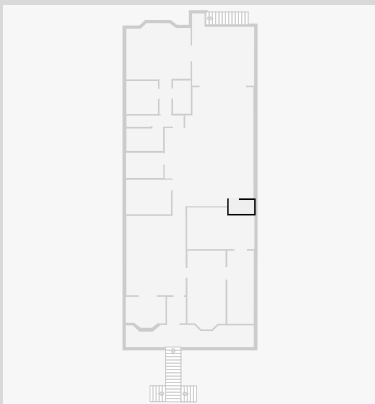



# 70 Jessie Street

## Sunroom

Width: 2.07 m  
 Length: 5.71 m  
 Area: 11.78 m<sup>2</sup>  
 Perimeter: 15.55 m

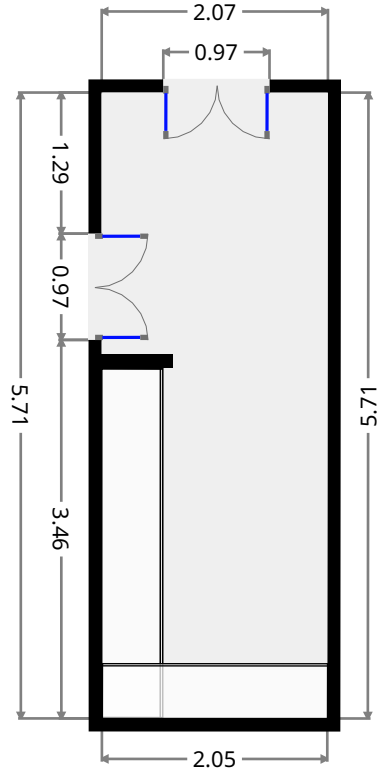
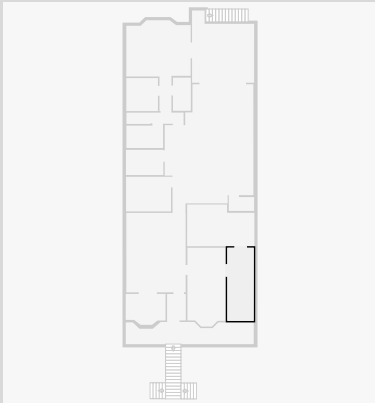

## Bedroom

Width: 2.97 m  
 Length: 6.16 m  
 Area: 17.57 m<sup>2</sup>  
 Perimeter: 17.73 m

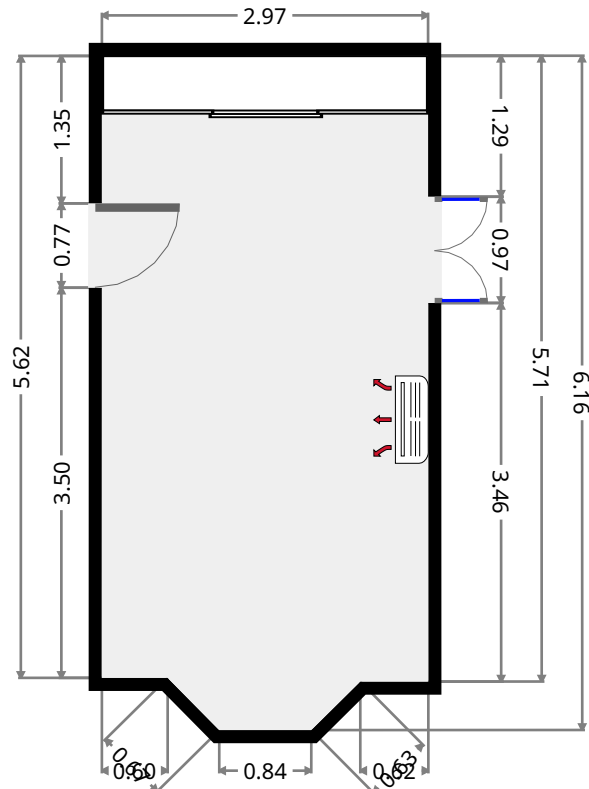
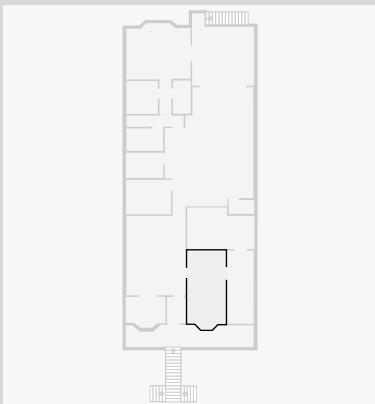

THIS FLOORPLAN IS PROVIDED WITHOUT WARRANTY OF ANY KIND. SENSOPIA DISCLAIMS ANY WARRANTY INCLUDING, WITHOUT LIMITATION, SATISFACTORY QUALITY OR ACCURACY OF DIMENSIONS.

# 70 Jessie Street

## Sitting Room

Width: 2.41 m  
 Length: 3.11 m  
 Area: 6.88 m<sup>2</sup>  
 Perimeter: 10.57 m

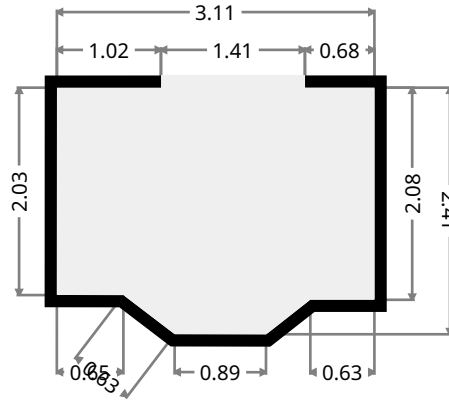
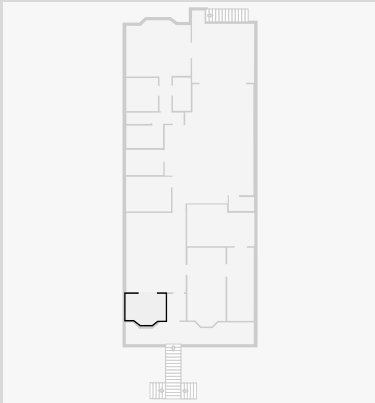

## Living Room

Width: 4.64 m  
 Length: 6.20 m  
 Area: 28.75 m<sup>2</sup>  
 Perimeter: 21.68 m

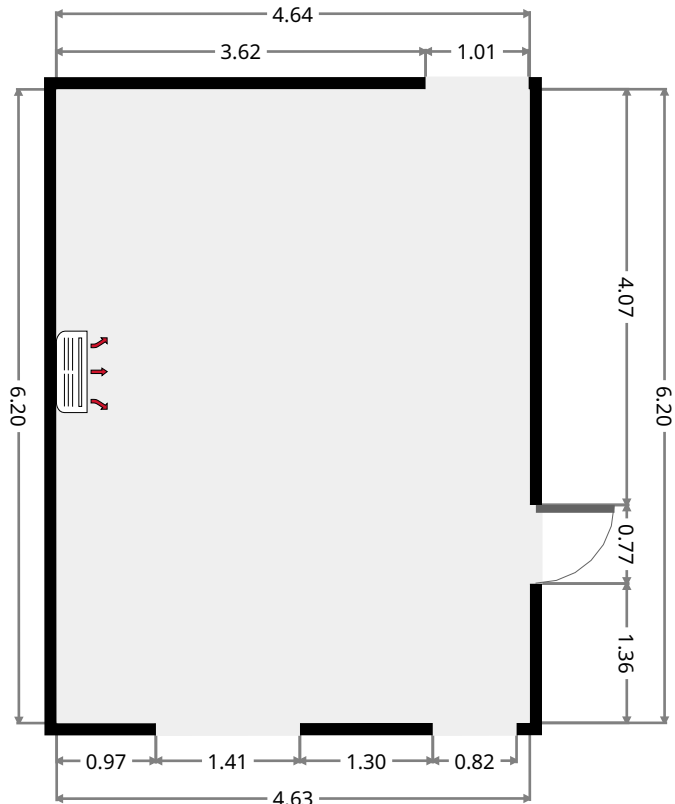
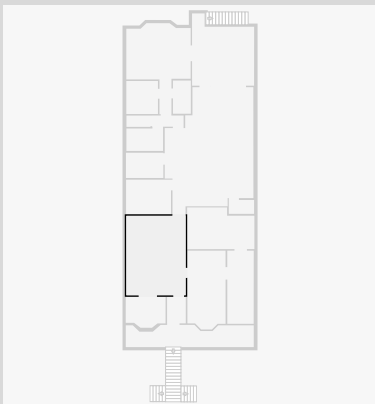

THIS FLOORPLAN IS PROVIDED WITHOUT WARRANTY OF ANY KIND. SENSOPIA DISCLAIMS ANY WARRANTY INCLUDING, WITHOUT LIMITATION, SATISFACTORY QUALITY OR ACCURACY OF DIMENSIONS.