

7 Westmoreland Street

SUBMITTED BY

Ray White Rockhampton Casey
stockers@cqoz.com

CREATED ON

2022-02-07

Floors

2

▼ Ground Floor

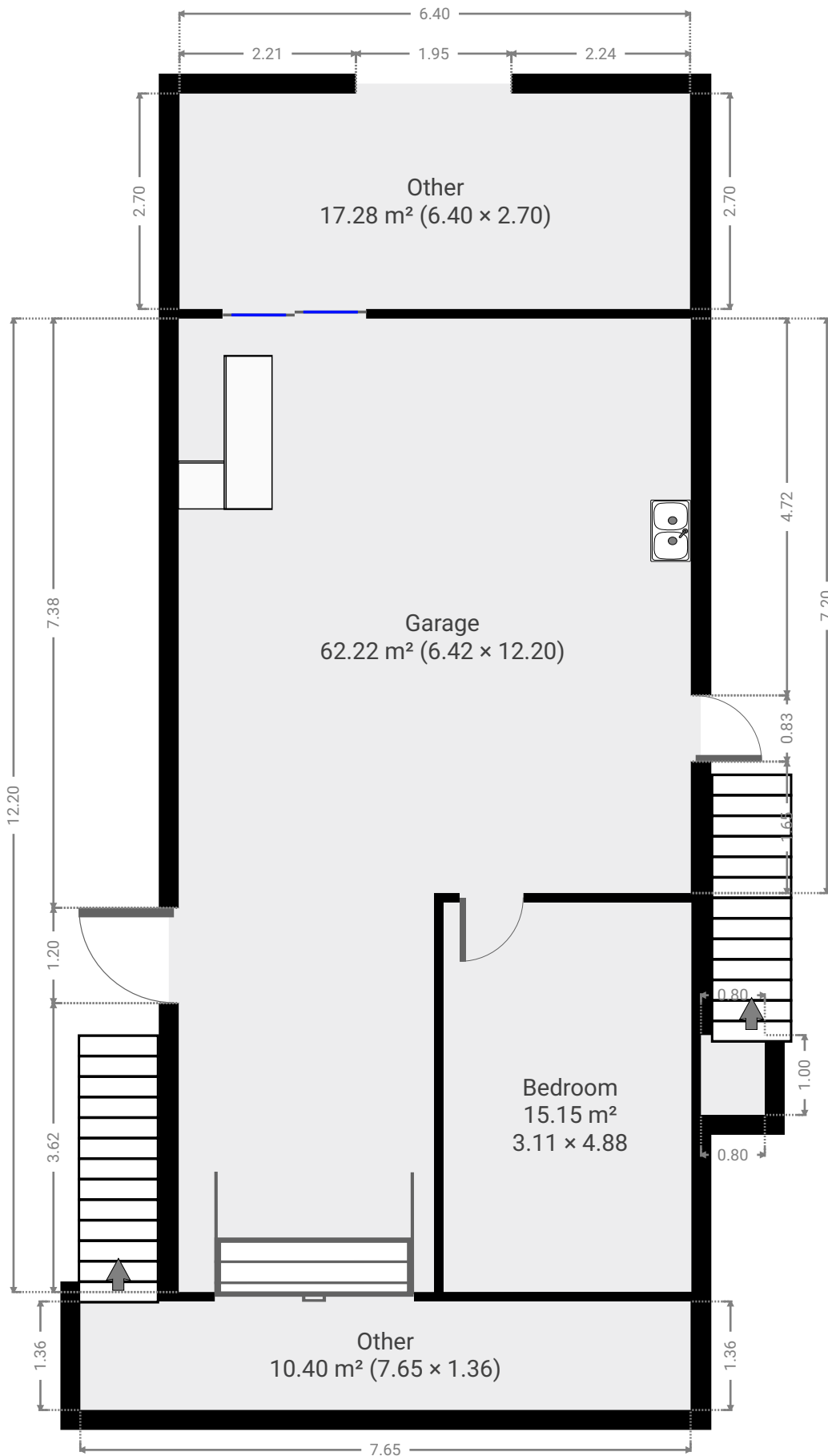

FLOORS: 2

▼ Garage
Ground Floor

WIDTH: 6.42 m • LENGTH: 12.20 m
AREA: 62.22 m² • PERIMETER: 37.24 m

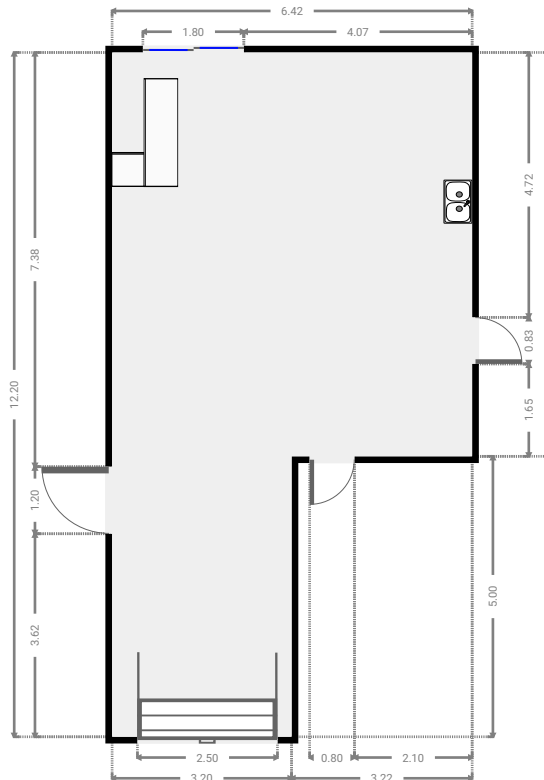
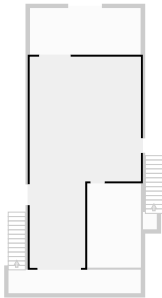

▼ Bedroom
Ground Floor

WIDTH: 3.11 m • LENGTH: 4.88 m
AREA: 15.15 m² • PERIMETER: 15.97 m

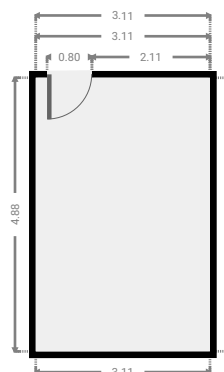
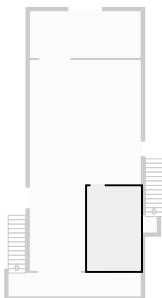

FLOORS: 2

▼ Other
Ground Floor

WIDTH: 6.40 m • LENGTH: 2.70 m
AREA: 17.28 m² • PERIMETER: 18.20 m

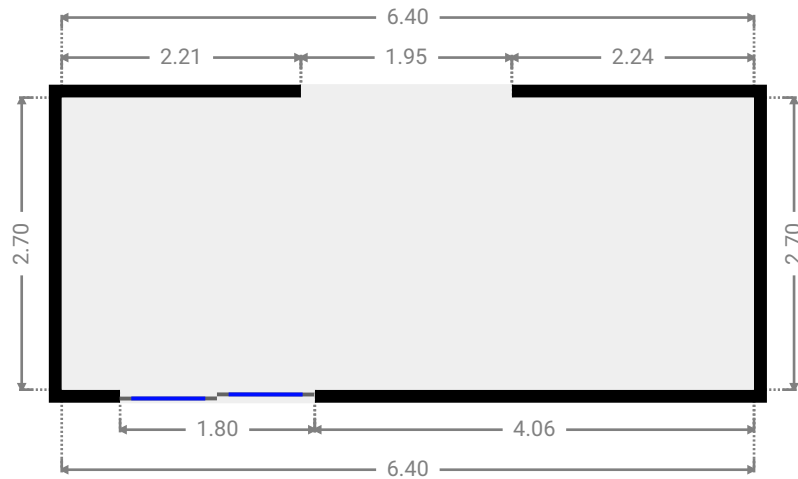

▼ Other
Ground Floor

WIDTH: 7.65 m • LENGTH: 1.36 m
AREA: 10.40 m² • PERIMETER: 18.02 m

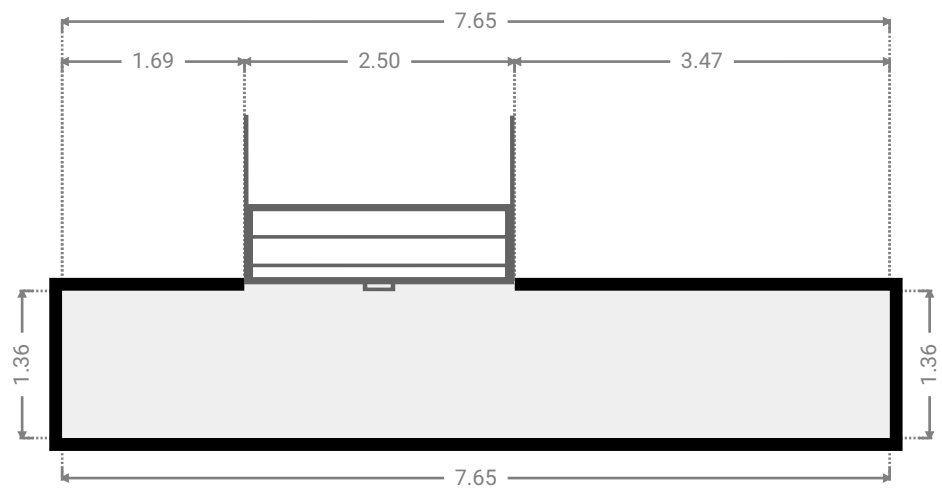

▼ **Attic / Loft**
Ground Floor

WIDTH: 0.80 m • LENGTH: 1.00 m
AREA: 0.80 m² • PERIMETER: 3.60 m

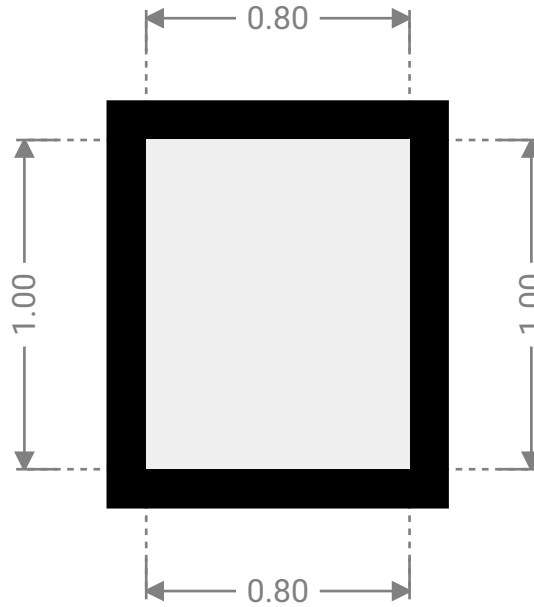
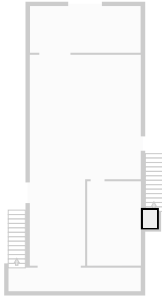

▼ 1st Floor

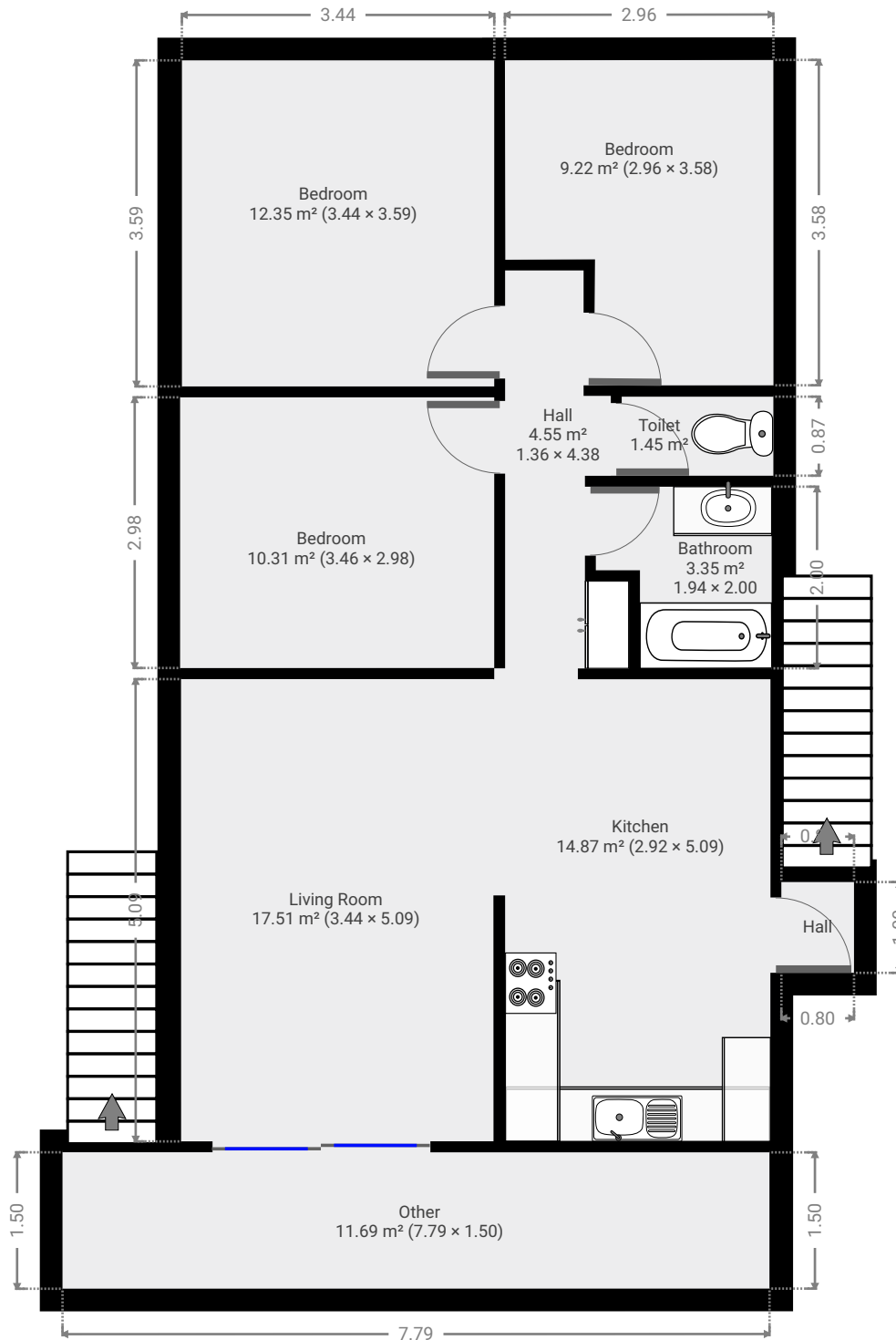

▼ Living Room
1st Floor

WIDTH: 3.44 m • LENGTH: 5.09 m
AREA: 17.51 m² • PERIMETER: 17.06 m

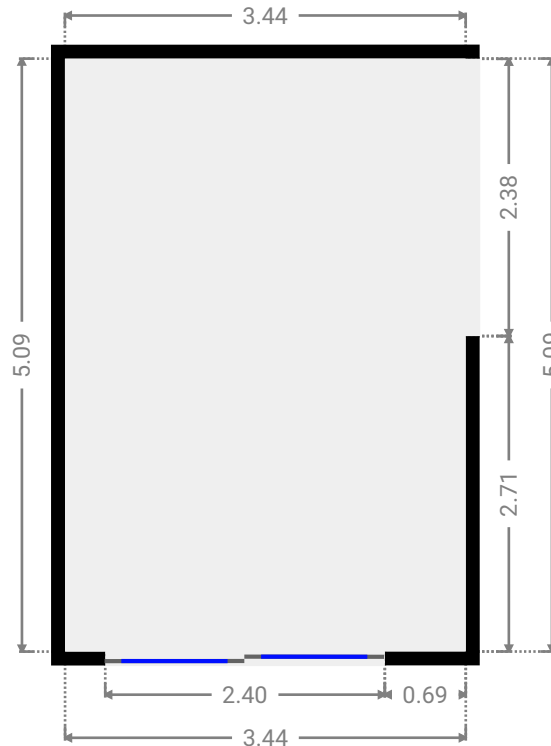
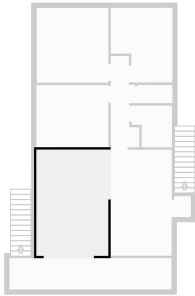

▼ Kitchen
1st Floor

WIDTH: 2.92 m • LENGTH: 5.09 m
AREA: 14.87 m² • PERIMETER: 16.02 m

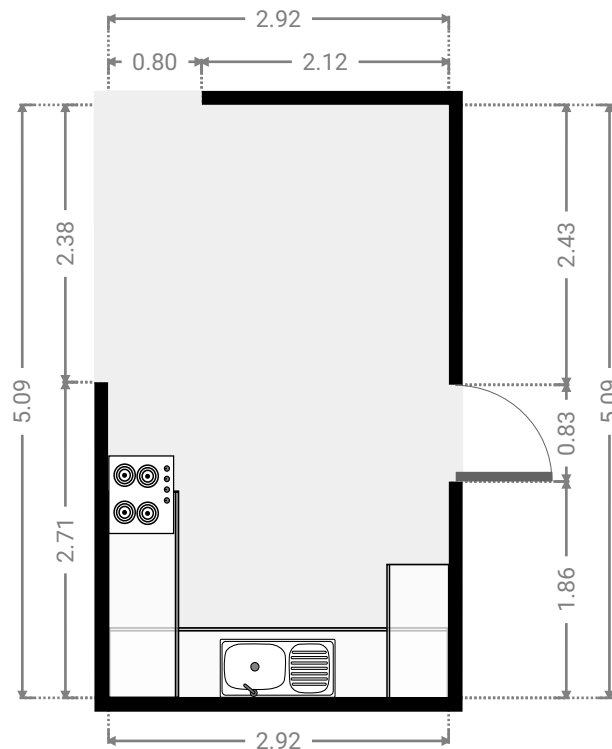
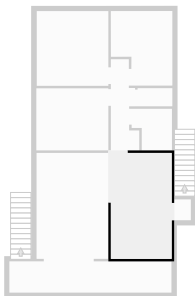

▼ **Hall**
1st Floor

WIDTH: 1.36 m • LENGTH: 4.38 m
AREA: 4.55 m² • PERIMETER: 12.06 m

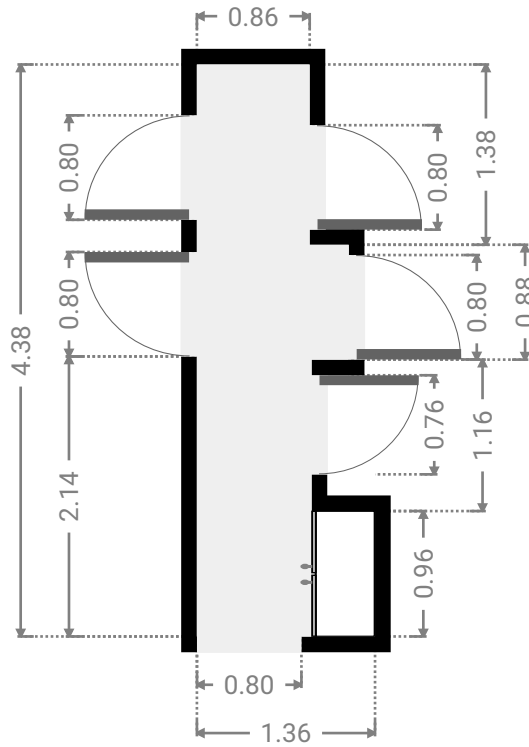
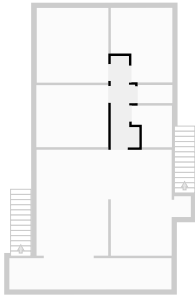

▼ **Bathroom**
1st Floor

WIDTH: 1.94 m • LENGTH: 2.00 m
AREA: 3.35 m² • PERIMETER: 7.87 m

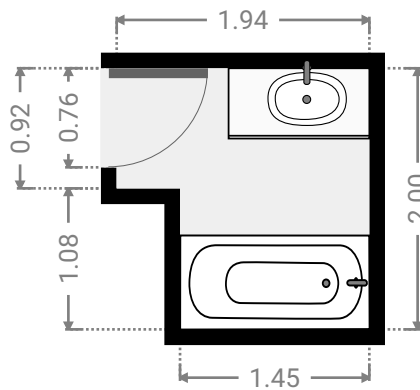
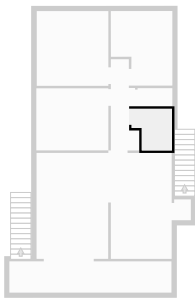

▼ **Toilet**
1st Floor

WIDTH: 1.67 m • LENGTH: 0.87 m
AREA: 1.45 m² • PERIMETER: 5.08 m

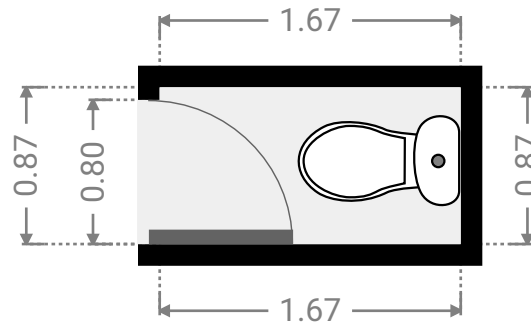
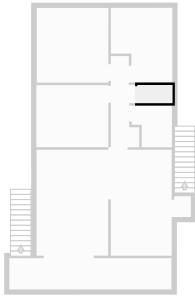

▼ **Bedroom**
1st Floor

WIDTH: 3.46 m • LENGTH: 2.98 m
AREA: 10.31 m² • PERIMETER: 12.88 m

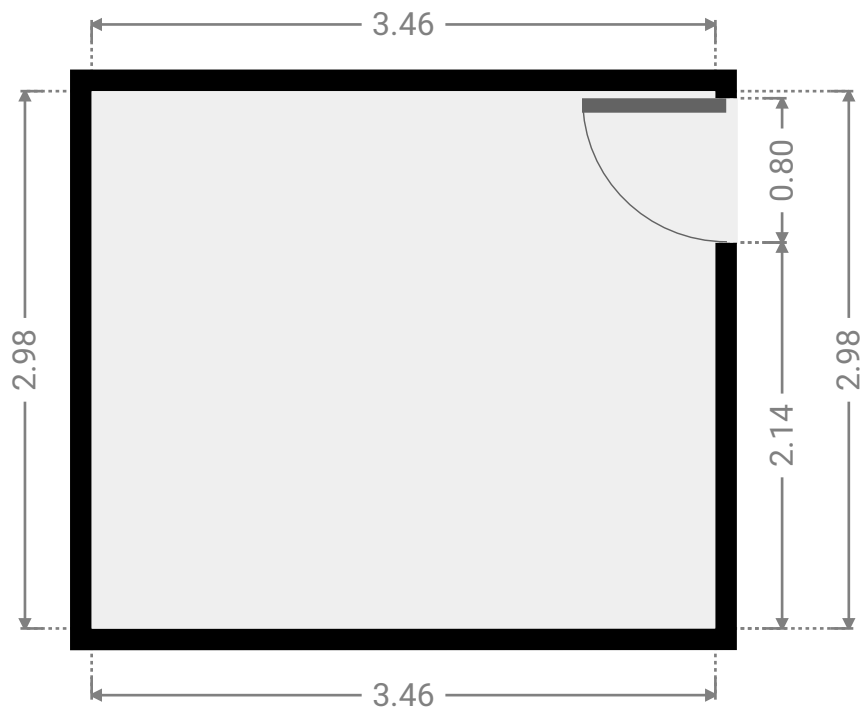
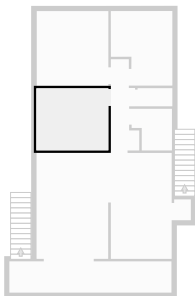

▼ **Bedroom**
1st Floor

WIDTH: 3.44 m • LENGTH: 3.59 m
AREA: 12.35 m² • PERIMETER: 14.06 m

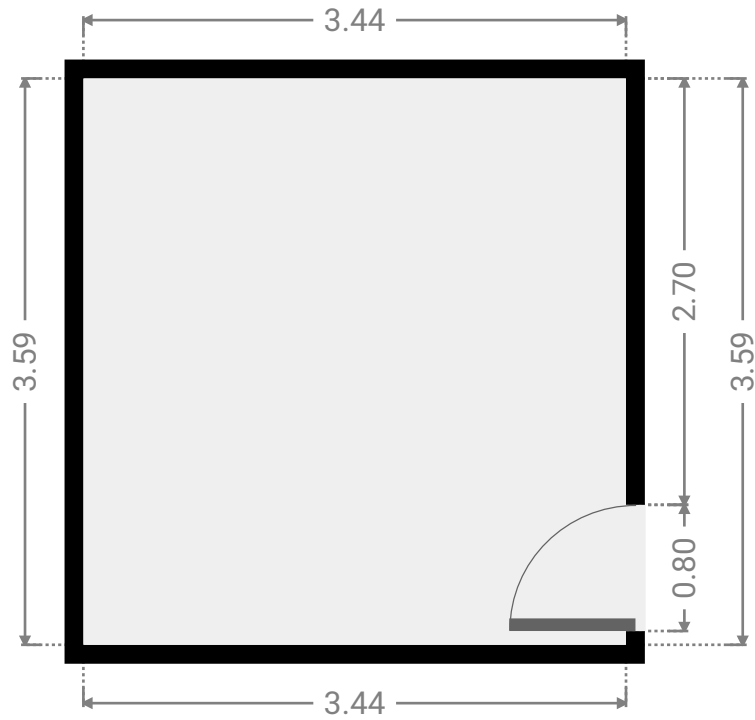
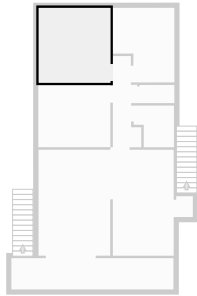

▼ **Bedroom**
1st Floor

WIDTH: 2.96 m • LENGTH: 3.58 m
AREA: 9.22 m² • PERIMETER: 13.09 m

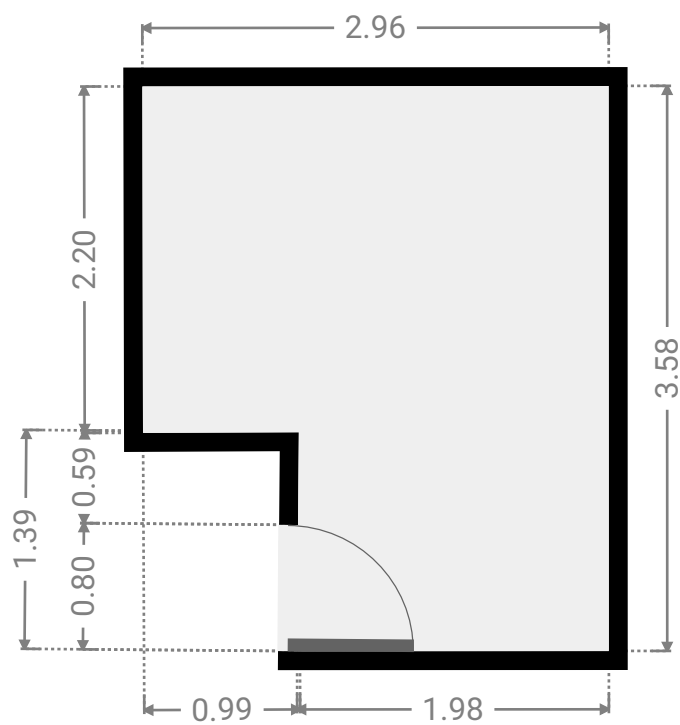
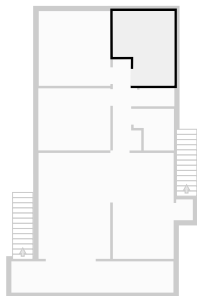

▼ **Hall**
1st Floor

WIDTH: 0.80 m • LENGTH: 1.00 m
AREA: 0.80 m² • PERIMETER: 3.60 m

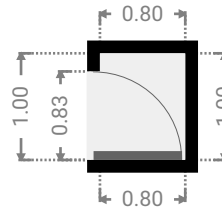
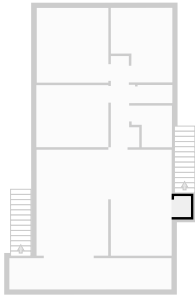

▼ **Other**
1st Floor

WIDTH: 7.79 m • LENGTH: 1.50 m
AREA: 11.69 m² • PERIMETER: 18.57 m

