

7 Mackinlay Street

Ground Floor

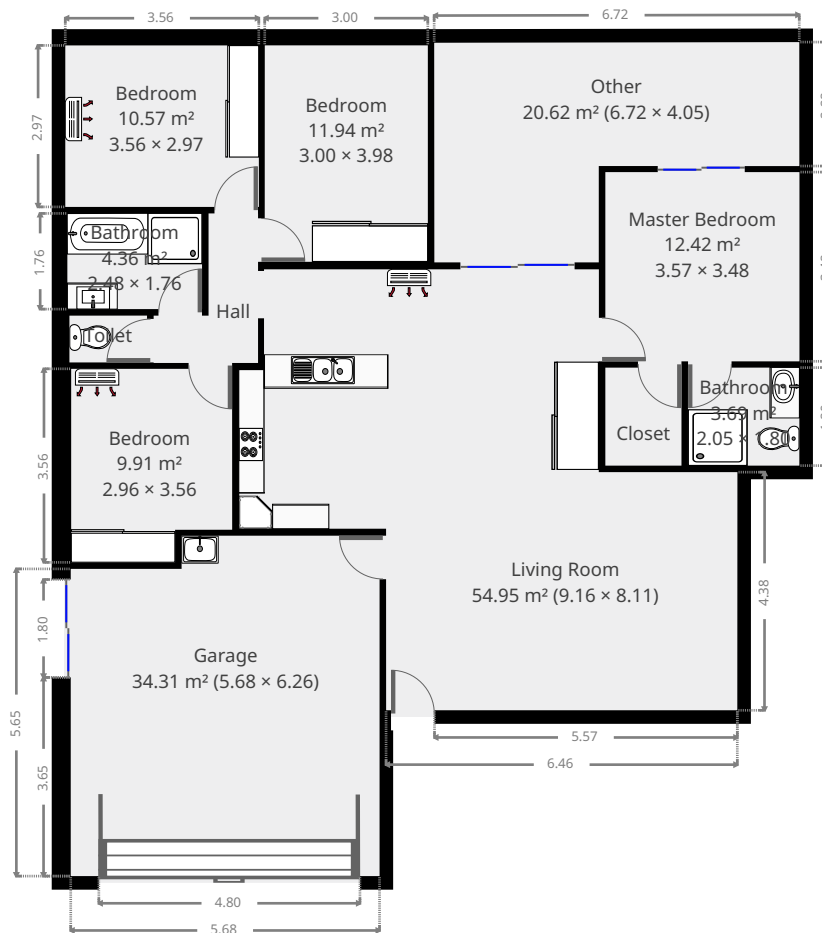

THIS FLOORPLAN IS PROVIDED WITHOUT WARRANTY OF ANY KIND. SENSOPIA DISCLAIMS ANY WARRANTY INCLUDING, WITHOUT LIMITATION, SATISFACTORY QUALITY OR ACCURACY OF DIMENSIONS.

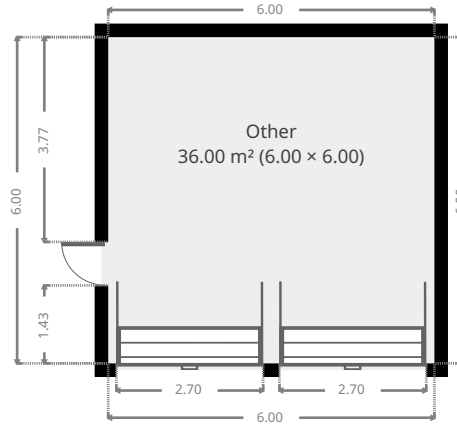

7 Mackinlay Street

Living Room

Width: 8.11 m
 Length: 9.16 m
 Area: 54.95 m²
 Perimeter: 34.55 m

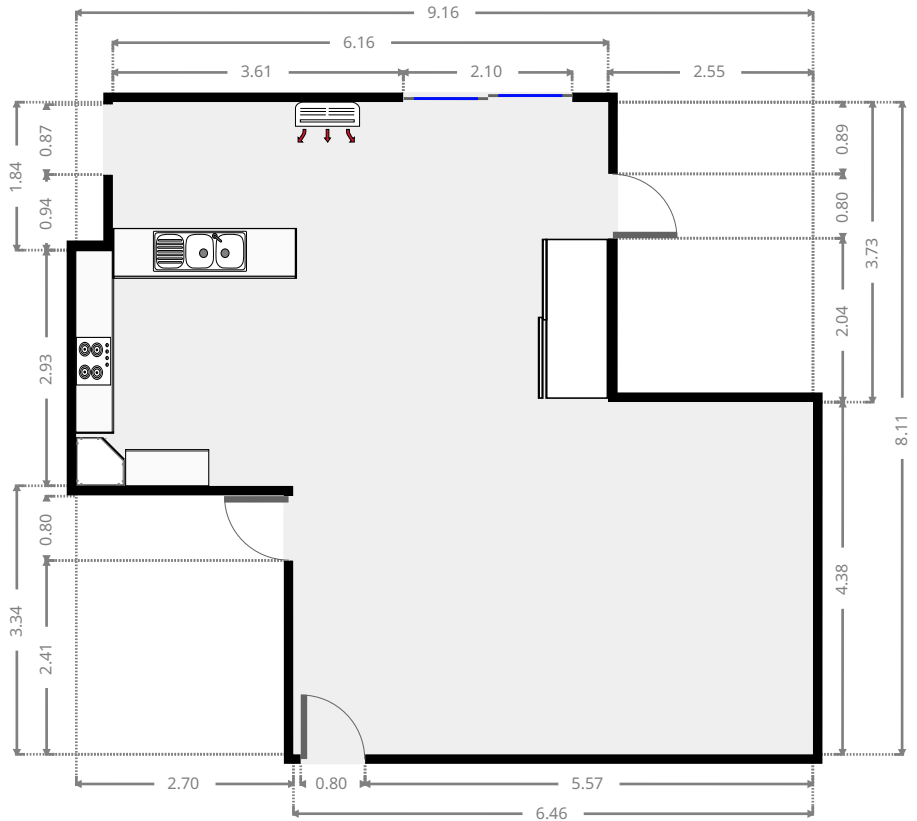
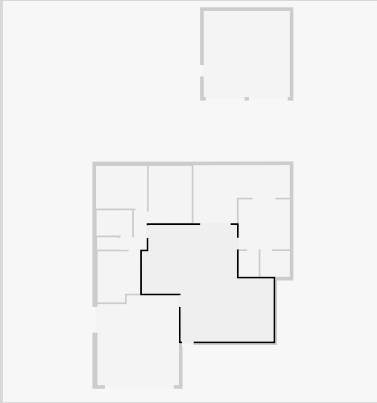

Master Bedroom

Width: 3.48 m
 Length: 3.57 m
 Area: 12.42 m²
 Perimeter: 14.10 m

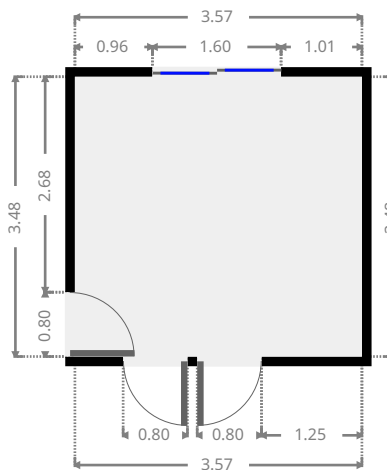
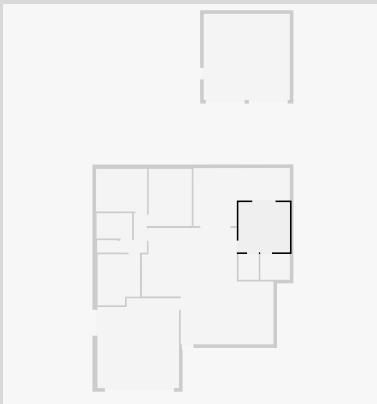

THIS FLOORPLAN IS PROVIDED WITHOUT WARRANTY OF ANY KIND. SENSOPIA DISCLAIMS ANY WARRANTY INCLUDING, WITHOUT LIMITATION, SATISFACTORY QUALITY OR ACCURACY OF DIMENSIONS.

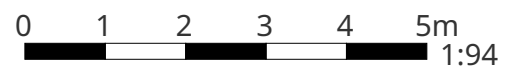

7 Mackinlay Street

Closet

Width: 1.40 m
Length: 1.80 m
Area: 2.52 m²
Perimeter: 6.40 m

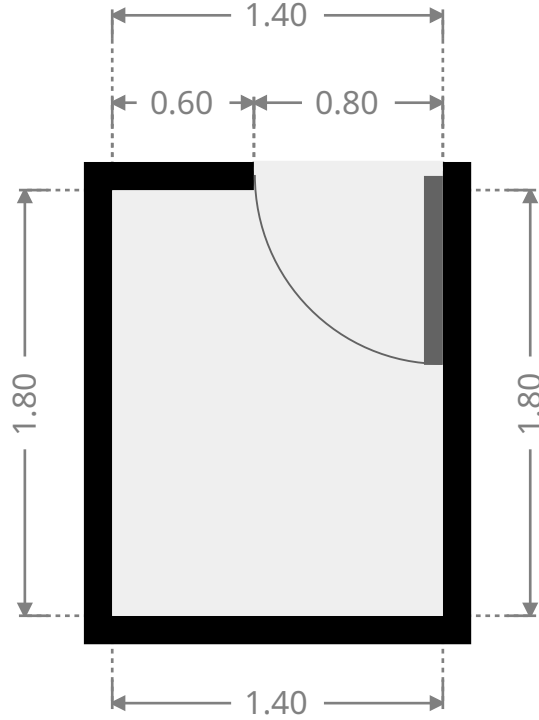
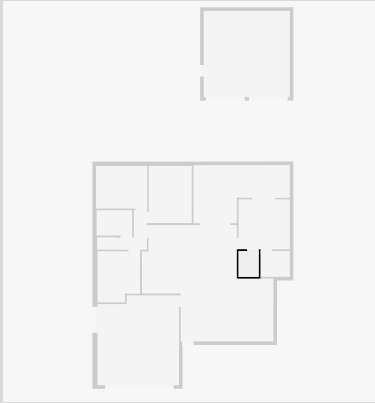

Bathroom

Width: 1.80 m
Length: 2.05 m
Area: 3.69 m²
Perimeter: 7.70 m

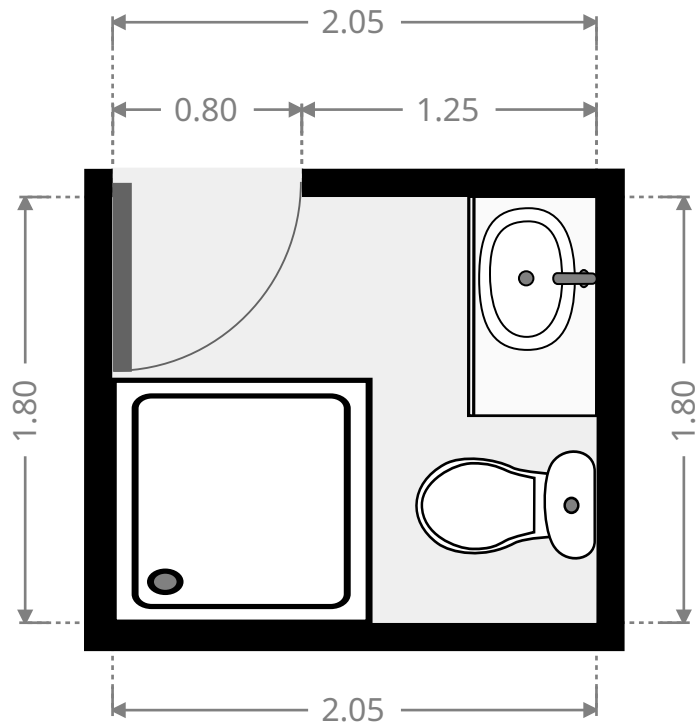
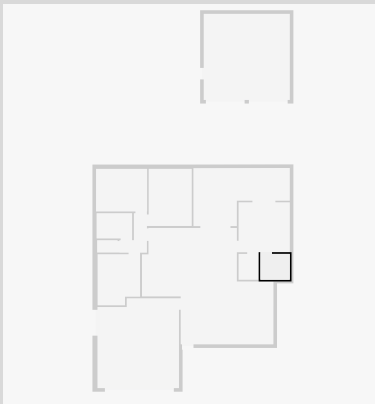

THIS FLOORPLAN IS PROVIDED WITHOUT WARRANTY OF ANY KIND. SENSOPIA DISCLAIMS ANY WARRANTY INCLUDING, WITHOUT LIMITATION, SATISFACTORY QUALITY OR ACCURACY OF DIMENSIONS.

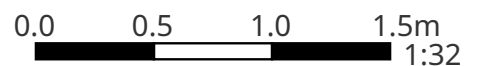

7 Mackinlay Street

Hall

Width: 1.92 m
 Length: 2.75 m
 Area: 3.38 m²
 Perimeter: 9.34 m

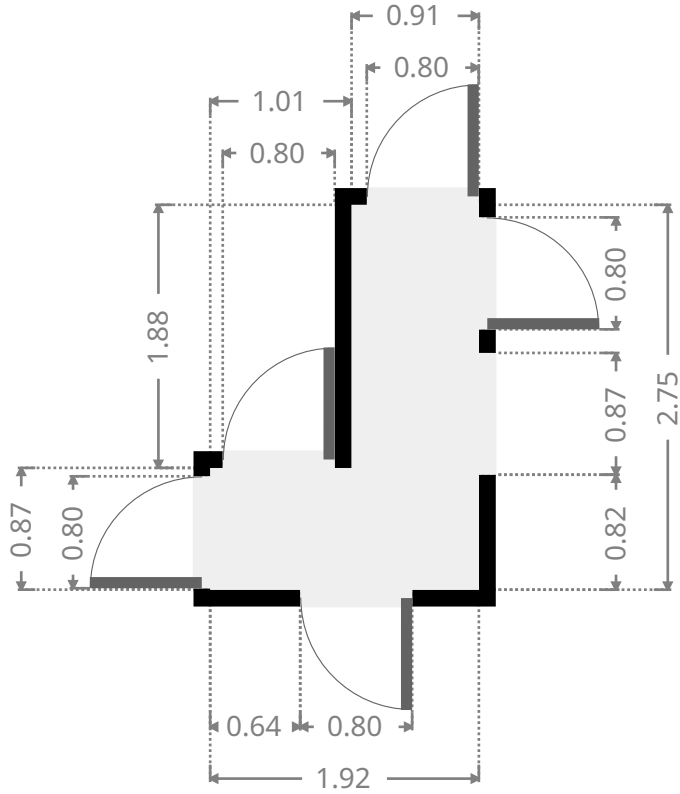
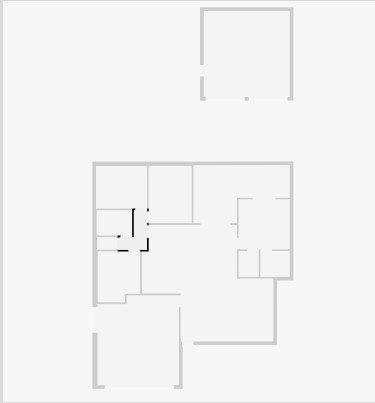

Bedroom

Width: 3.00 m
 Length: 3.98 m
 Area: 11.94 m²
 Perimeter: 13.96 m

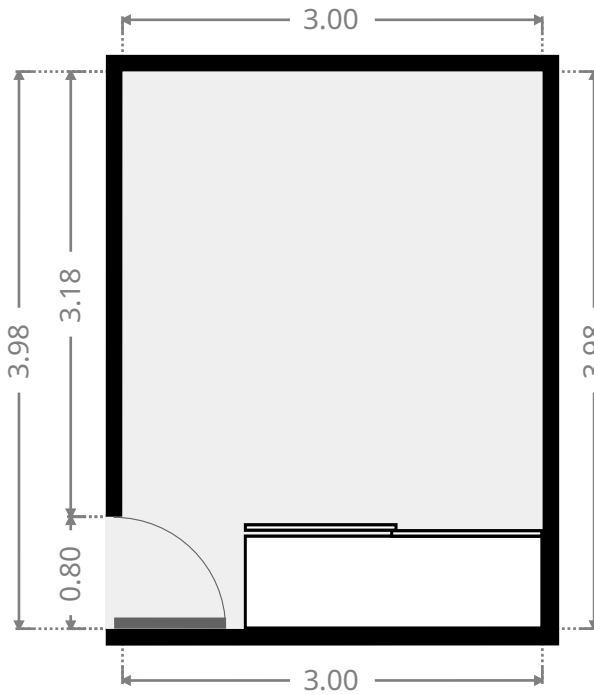
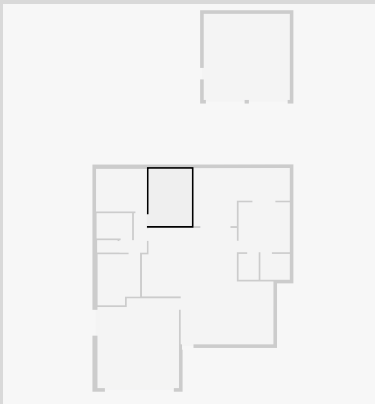

THIS FLOORPLAN IS PROVIDED WITHOUT WARRANTY OF ANY KIND. SENSOPIA DISCLAIMS ANY WARRANTY INCLUDING, WITHOUT LIMITATION, SATISFACTORY QUALITY OR ACCURACY OF DIMENSIONS.

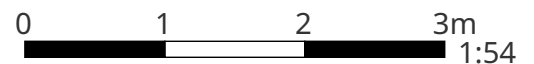

7 Mackinlay Street

Bedroom

Width: 2.97 m
 Length: 3.56 m
 Area: 10.57 m²
 Perimeter: 13.06 m

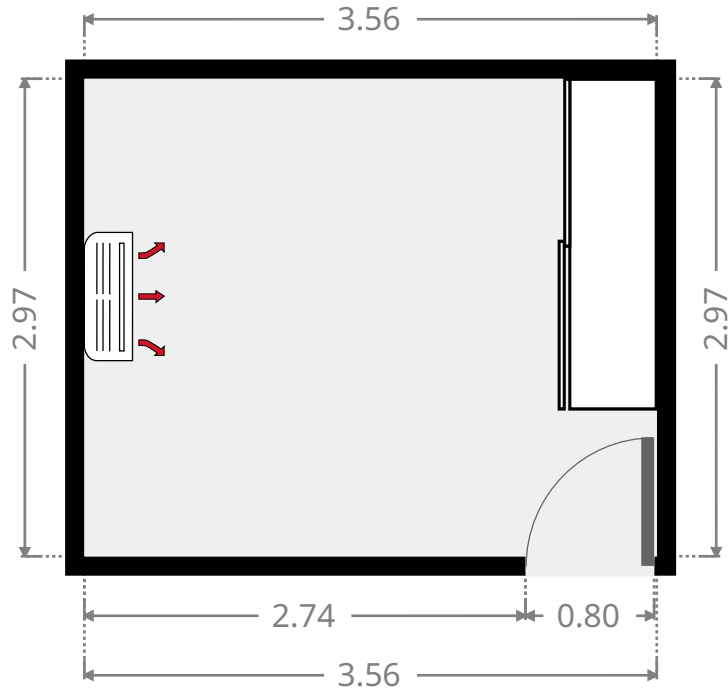
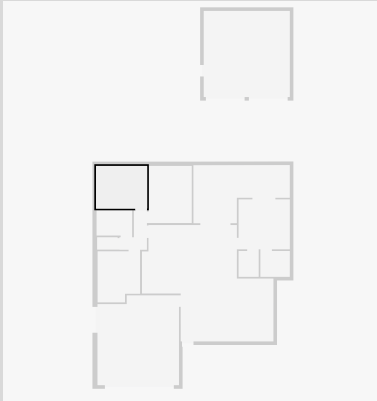

Bedroom

Width: 2.96 m
 Length: 3.56 m
 Area: 9.91 m²
 Perimeter: 13.04 m

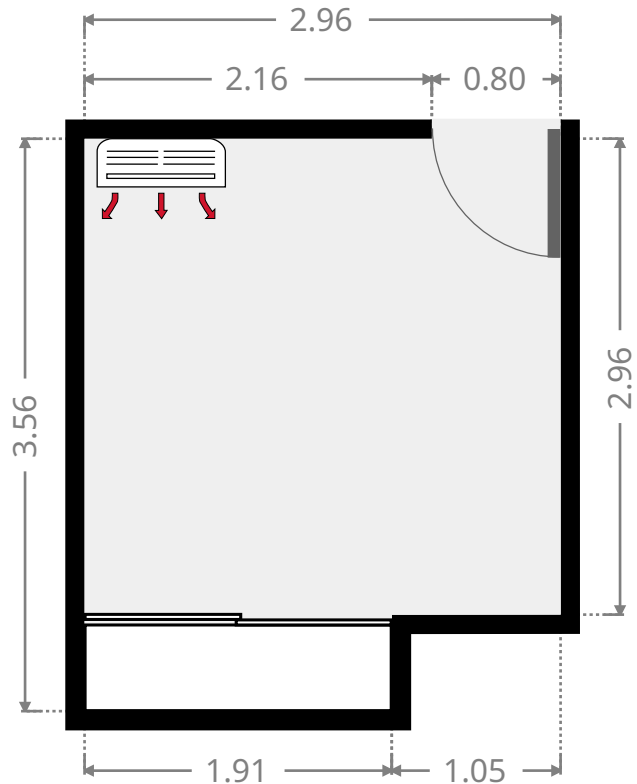
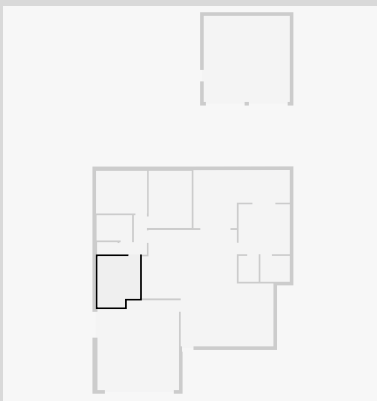

THIS FLOORPLAN IS PROVIDED WITHOUT WARRANTY OF ANY KIND. SENSOPIA DISCLAIMS ANY WARRANTY INCLUDING, WITHOUT LIMITATION, SATISFACTORY QUALITY OR ACCURACY OF DIMENSIONS.

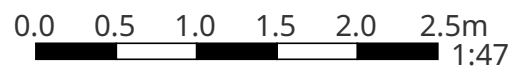

7 Mackinlay Street

Toilet / Half Bath

Width: 0.86 m
Length: 1.43 m
Area: 1.23 m²
Perimeter: 4.58 m

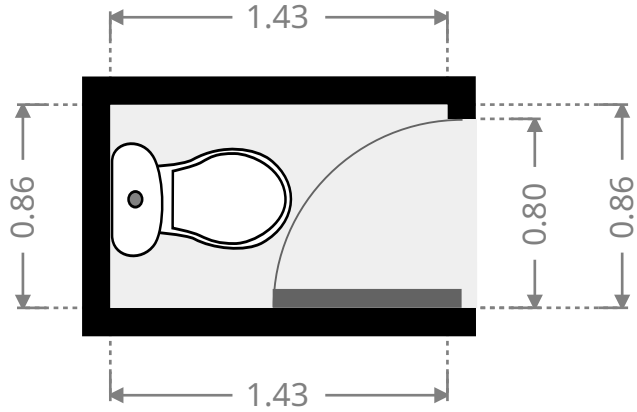
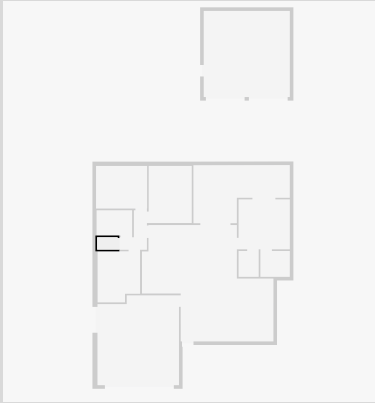

Bathroom

Width: 1.76 m
Length: 2.48 m
Area: 4.36 m²
Perimeter: 8.47 m

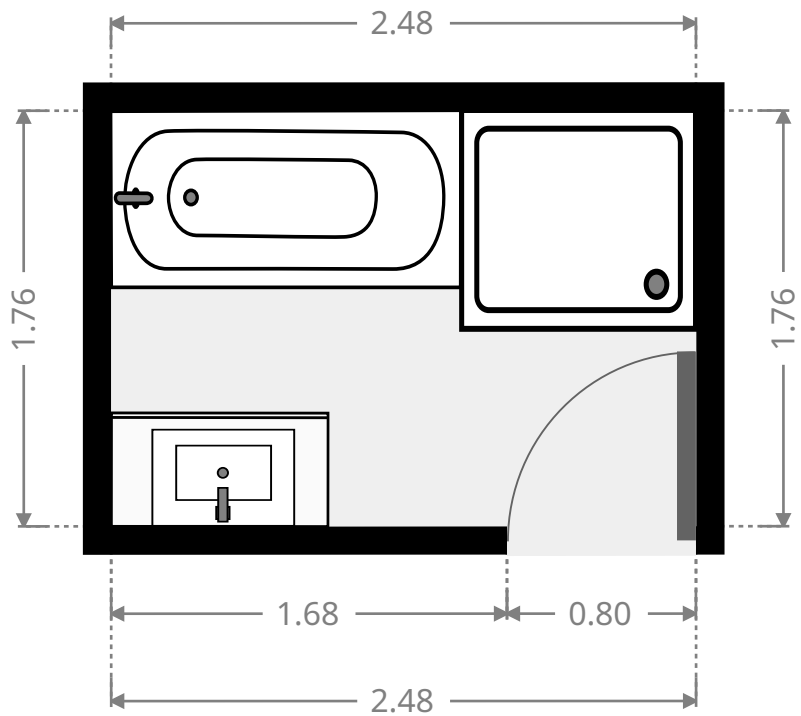
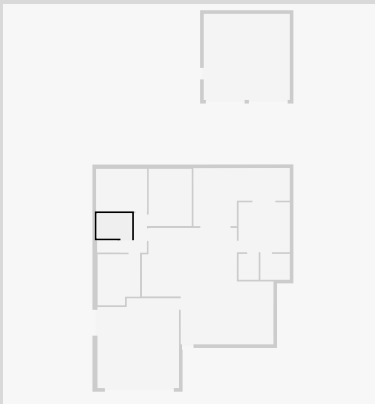

THIS FLOORPLAN IS PROVIDED WITHOUT WARRANTY OF ANY KIND. SENSOPIA DISCLAIMS ANY WARRANTY INCLUDING, WITHOUT LIMITATION, SATISFACTORY QUALITY OR ACCURACY OF DIMENSIONS.

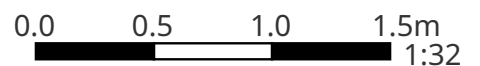

7 Mackinlay Street

Garage

Width: 5.68 m
 Length: 6.26 m
 Area: 34.31 m²
 Perimeter: 23.88 m

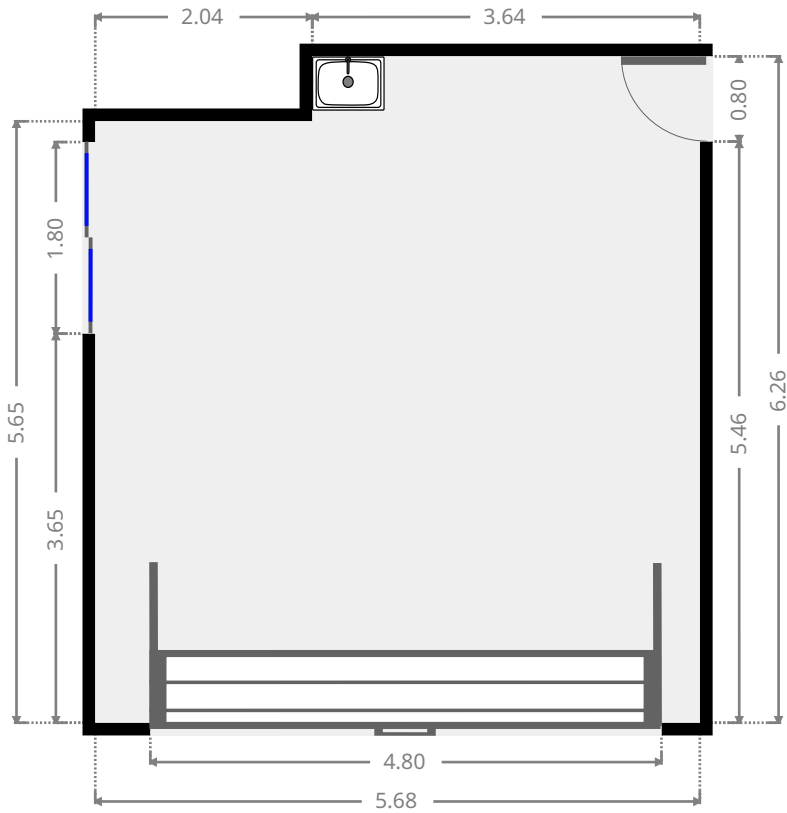
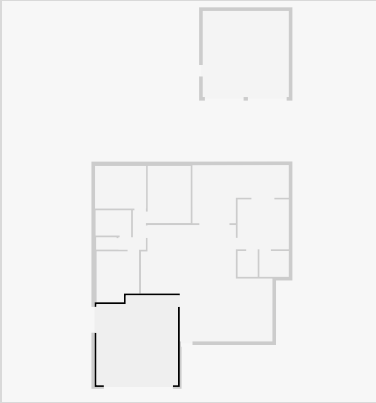

Other

Width: 4.05 m
 Length: 6.72 m
 Area: 20.62 m²
 Perimeter: 21.52 m

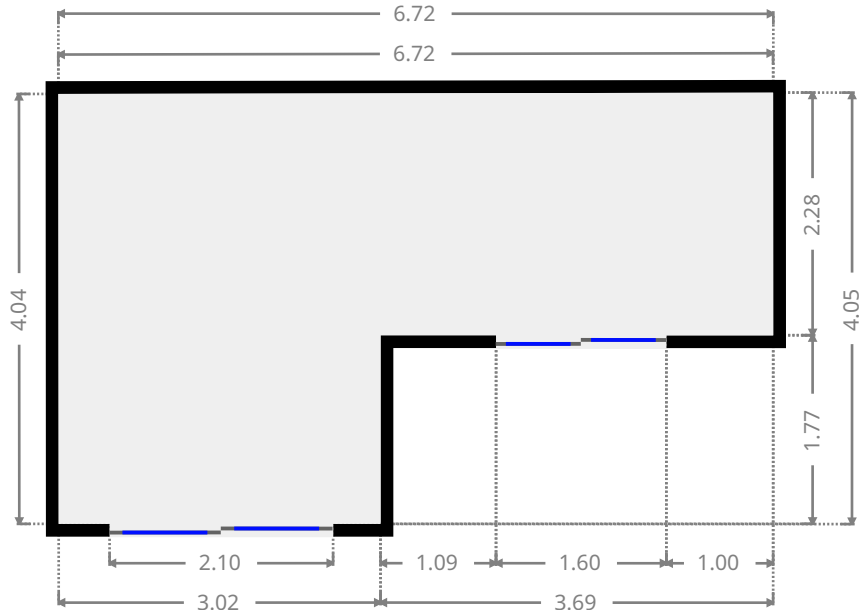
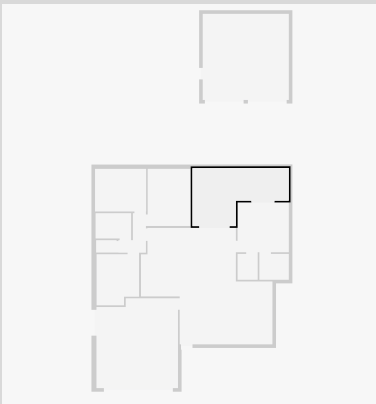

THIS FLOORPLAN IS PROVIDED WITHOUT WARRANTY OF ANY KIND. SENSOPIA DISCLAIMS ANY WARRANTY INCLUDING, WITHOUT LIMITATION, SATISFACTORY QUALITY OR ACCURACY OF DIMENSIONS.



7 Mackinlay Street

Other

Width: 6.00 m
Length: 6.00 m
Area: 36.00 m²
Perimeter: 24.00 m

