

# 7 Hearn Street

**SUBMITTED BY**

Ray White Rockhampton Casey  
stockers@cqoz.com

---

**CREATED ON**

2022-02-24

---

**Floors**

2

---

▼ Ground Floor

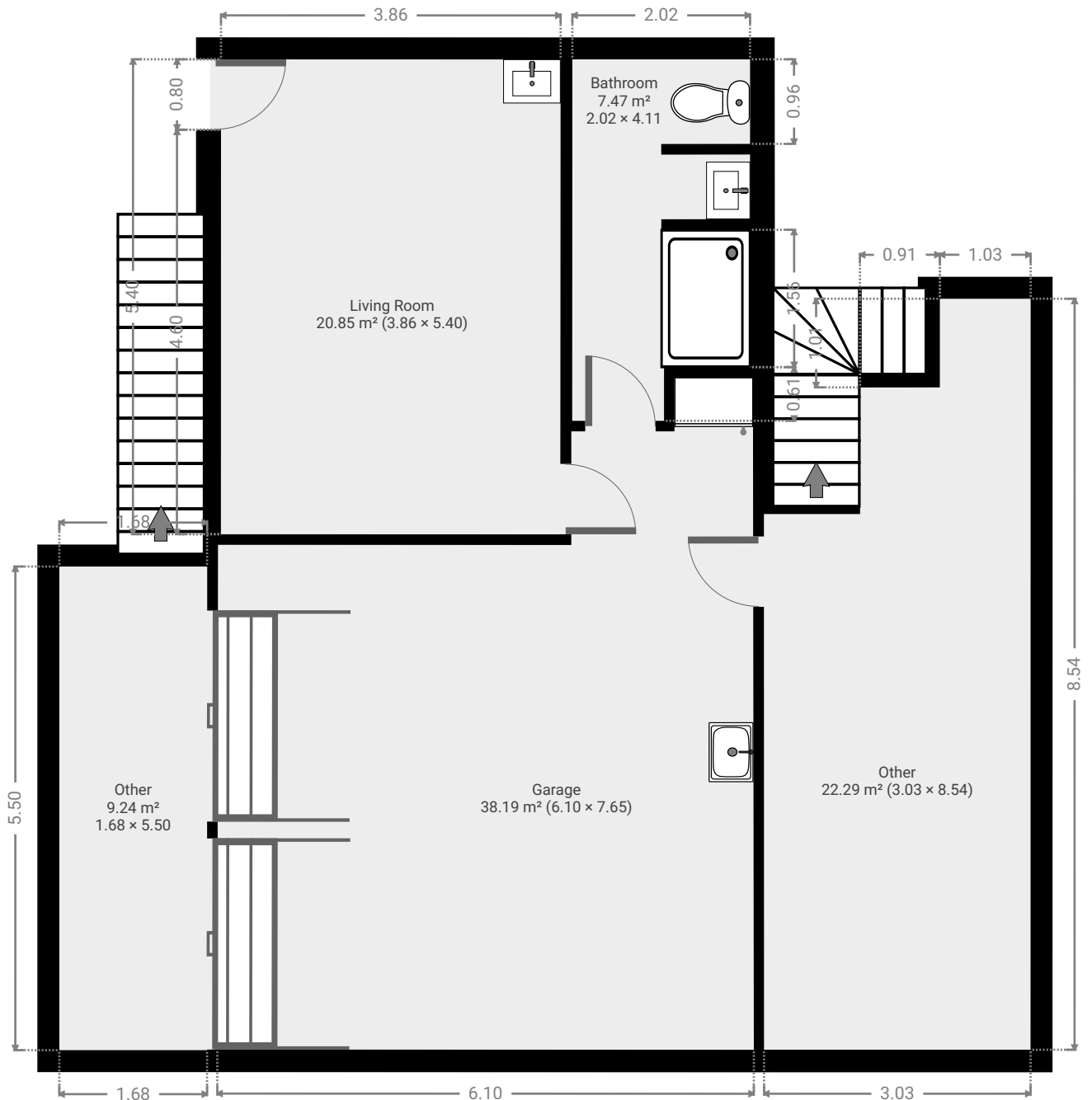

▼ Bathroom  
Ground Floor

WIDTH: 4.11 m • LENGTH: 2.02 m  
AREA: 7.47 m<sup>2</sup> • PERIMETER: 16.30 m

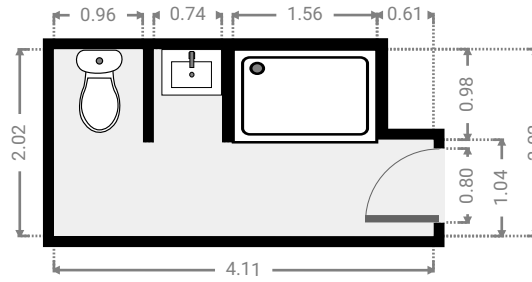
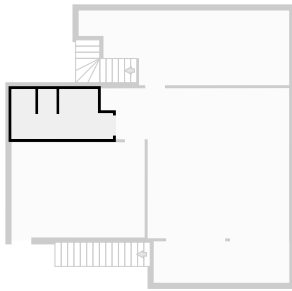

▼ Garage  
Ground Floor

WIDTH: 7.65 m • LENGTH: 6.10 m  
AREA: 38.19 m<sup>2</sup> • PERIMETER: 27.47 m

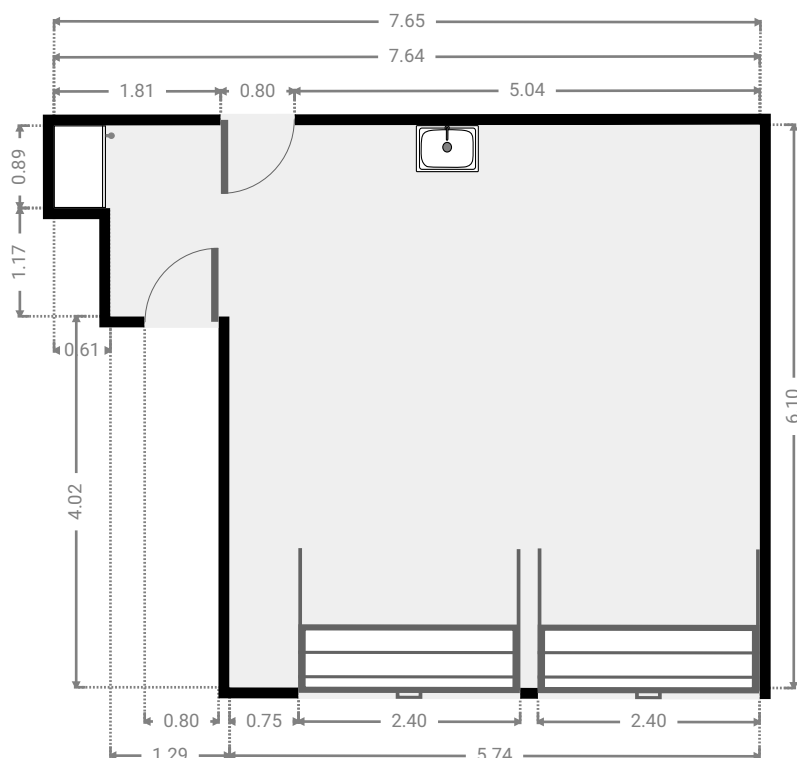
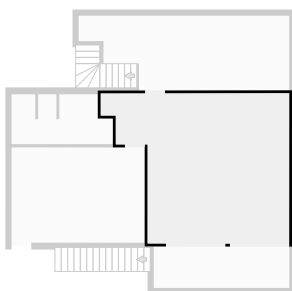

▼ **Living Room**  
Ground Floor

WIDTH: 5.40 m • LENGTH: 3.86 m  
AREA: 20.85 m<sup>2</sup> • PERIMETER: 18.52 m

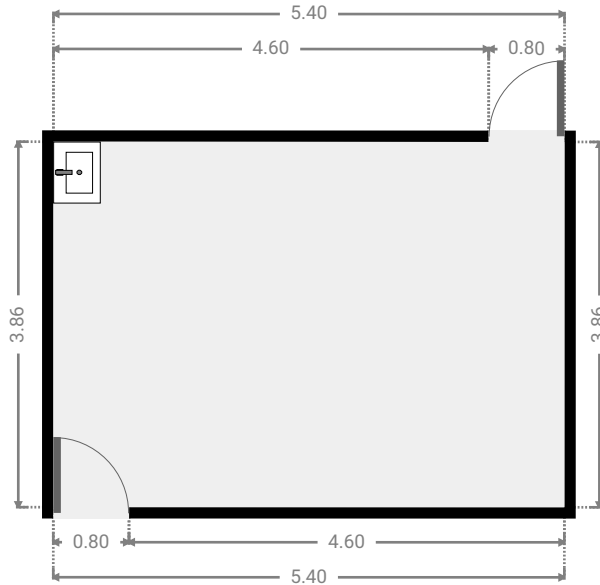
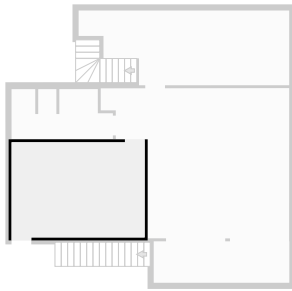

▼ **Other**  
Ground Floor

WIDTH: 8.54 m • LENGTH: 3.03 m  
AREA: 22.29 m<sup>2</sup> • PERIMETER: 23.14 m

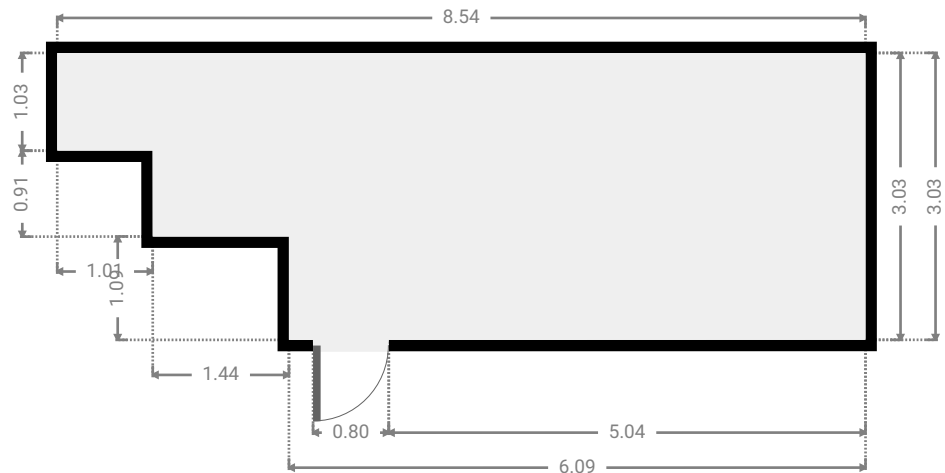
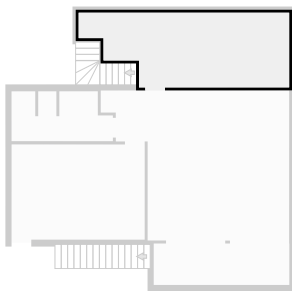

## ▼ Other Ground Floor

WIDTH: 5.50 m • LENGTH: 1.68 m  
AREA: 9.24 m<sup>2</sup> • PERIMETER: 14.36 m

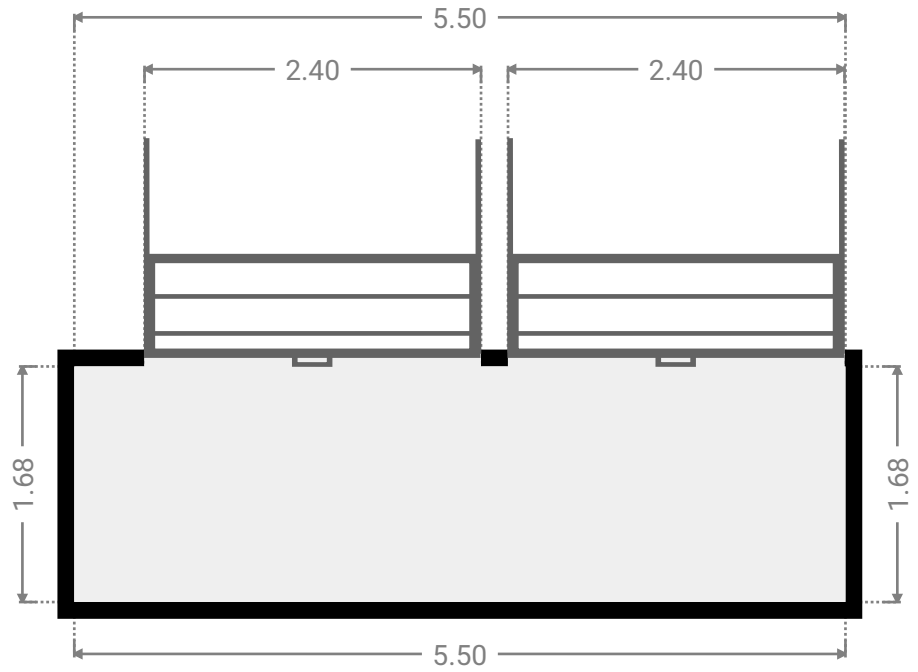
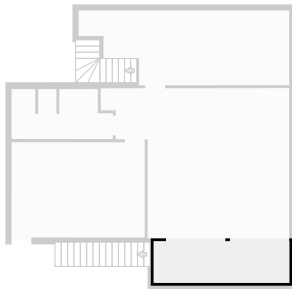

▼ 1st Floor

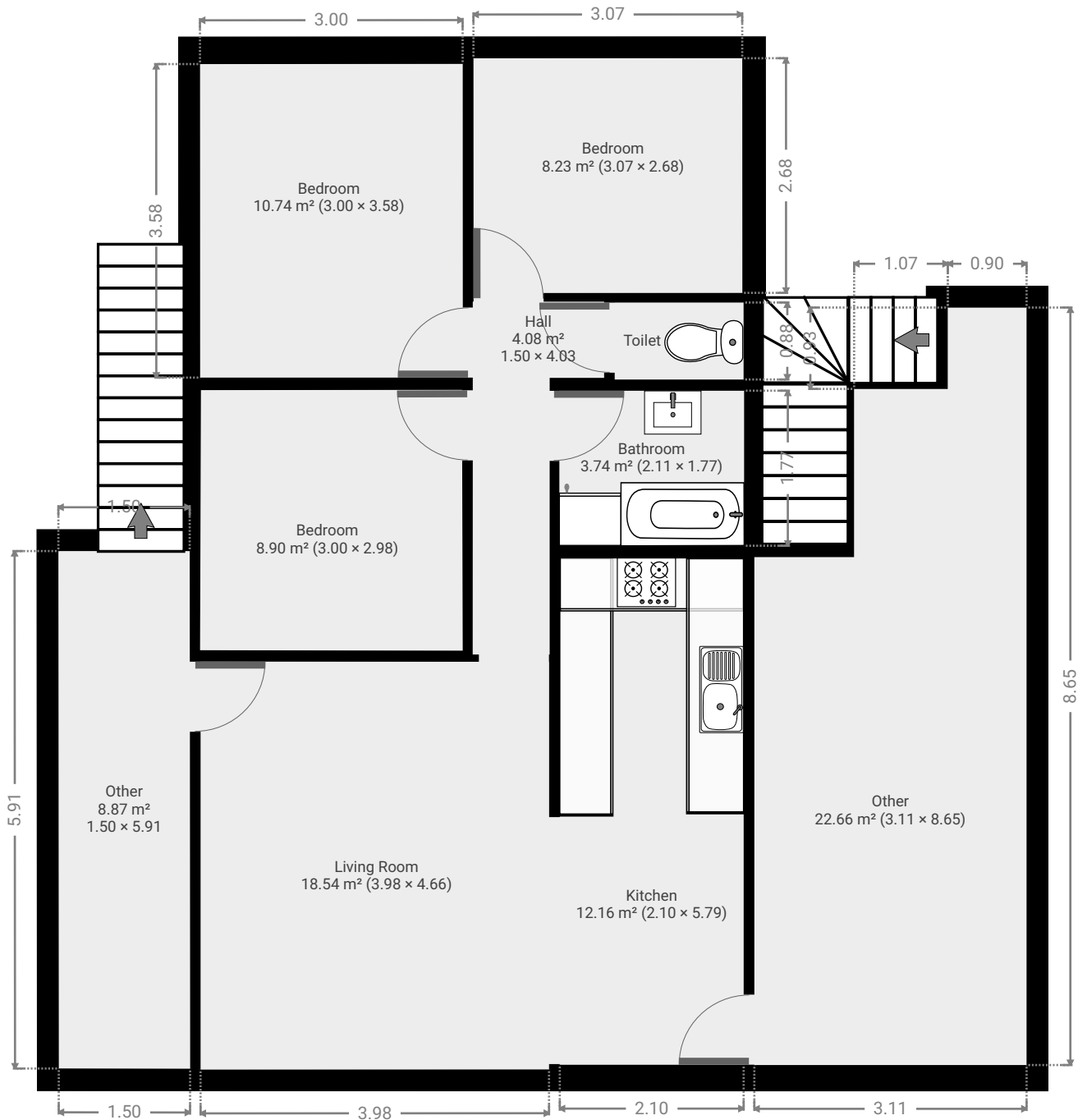

▼ **Bathroom**  
1st Floor

WIDTH: 1.77 m • LENGTH: 2.11 m  
AREA: 3.74 m<sup>2</sup> • PERIMETER: 7.76 m

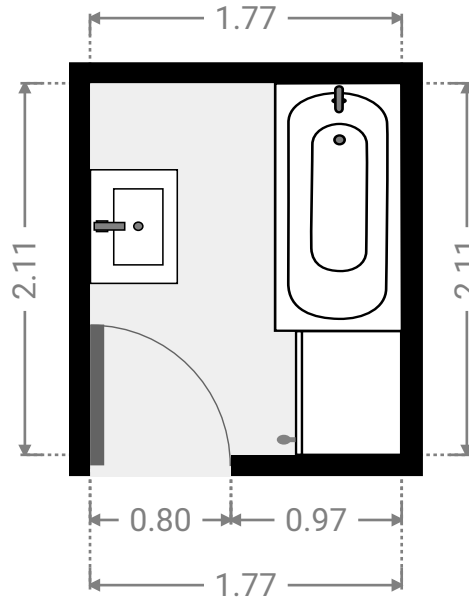
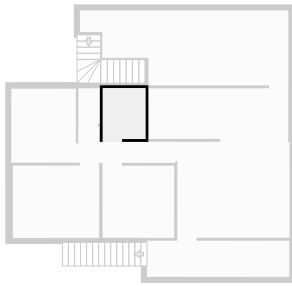

▼ **Bedroom**  
1st Floor

WIDTH: 2.68 m • LENGTH: 3.07 m  
AREA: 8.23 m<sup>2</sup> • PERIMETER: 11.50 m

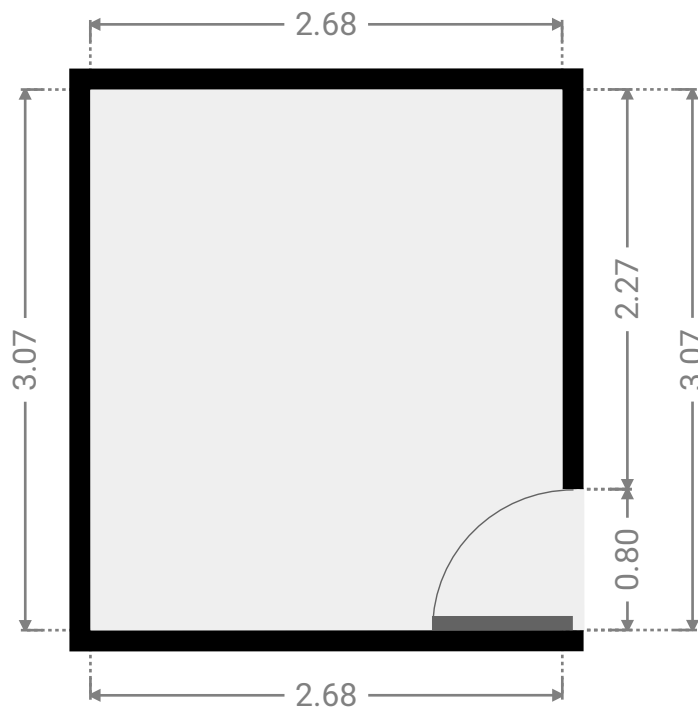
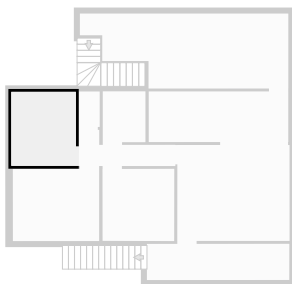

▼ **Bedroom**  
1st Floor

WIDTH: 3.58 m • LENGTH: 3.00 m  
AREA: 10.74 m<sup>2</sup> • PERIMETER: 13.16 m

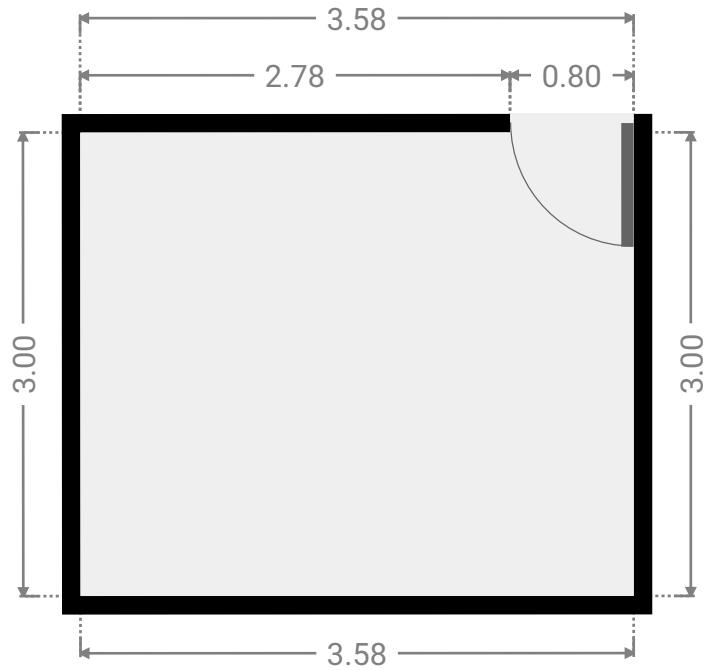
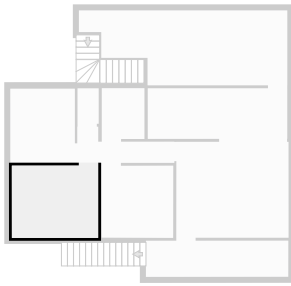

▼ **Bedroom**  
1st Floor

WIDTH: 2.98 m • LENGTH: 3.00 m  
AREA: 8.90 m<sup>2</sup> • PERIMETER: 11.93 m

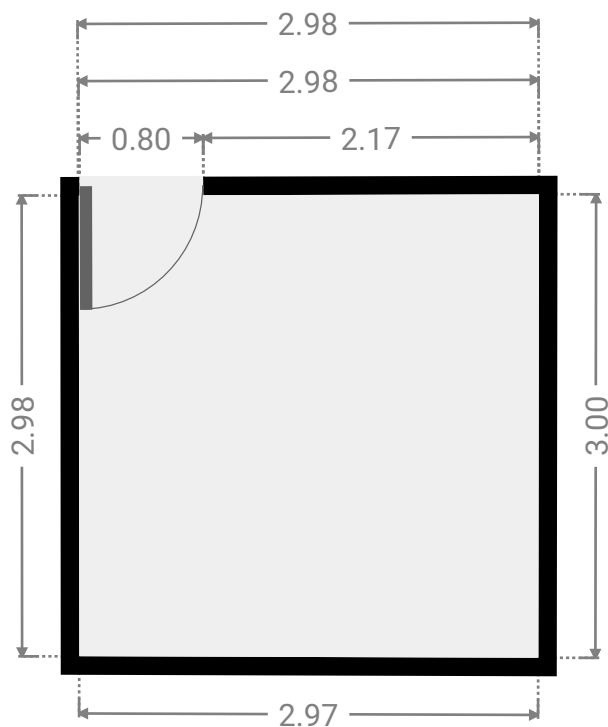
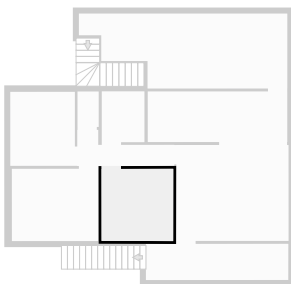



▼ **Hall**  
1st Floor

WIDTH: 4.03 m • LENGTH: 1.50 m  
AREA: 4.08 m<sup>2</sup> • PERIMETER: 11.06 m

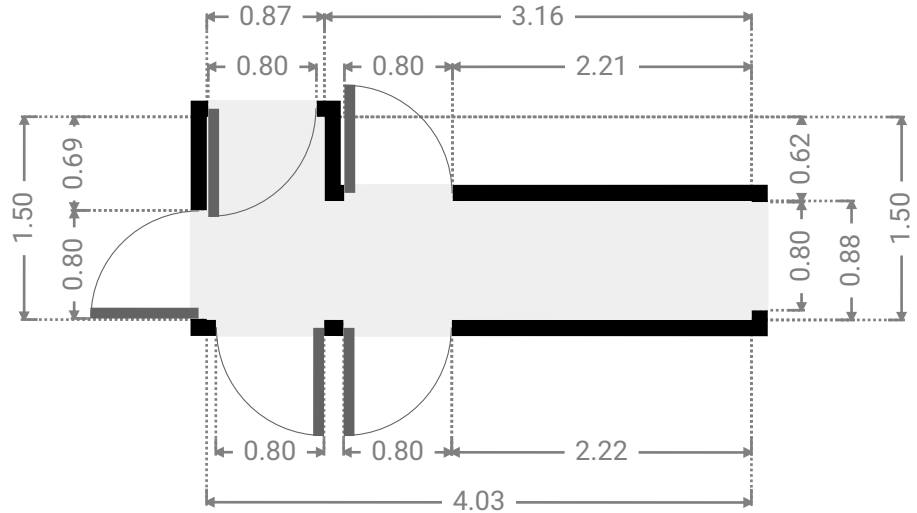
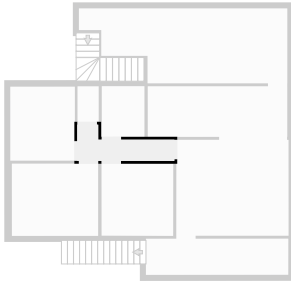

▼ **Kitchen**  
1st Floor

WIDTH: 5.79 m • LENGTH: 2.10 m  
AREA: 12.16 m<sup>2</sup> • PERIMETER: 15.78 m

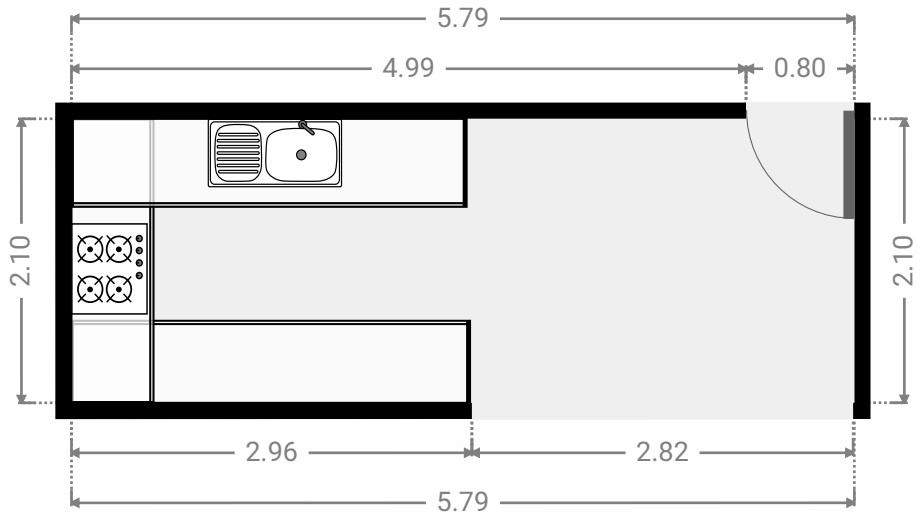
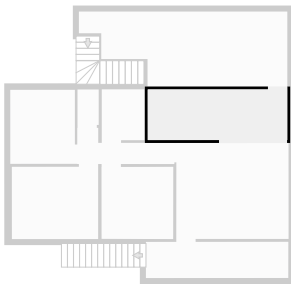

▼ Living Room  
1st Floor

WIDTH: 4.66 m • LENGTH: 3.98 m  
AREA: 18.54 m<sup>2</sup> • PERIMETER: 17.28 m

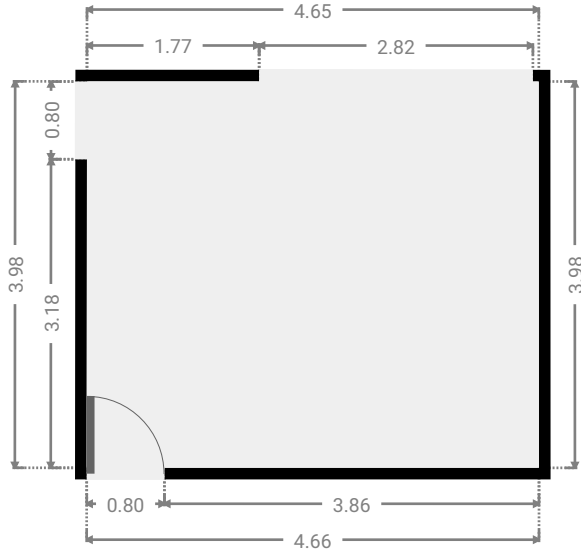
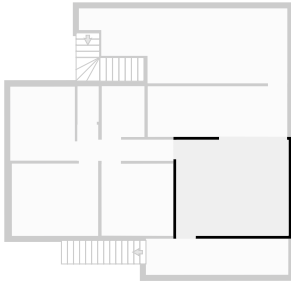

▼ Other  
1st Floor

WIDTH: 8.65 m • LENGTH: 3.11 m  
AREA: 22.66 m<sup>2</sup> • PERIMETER: 23.52 m

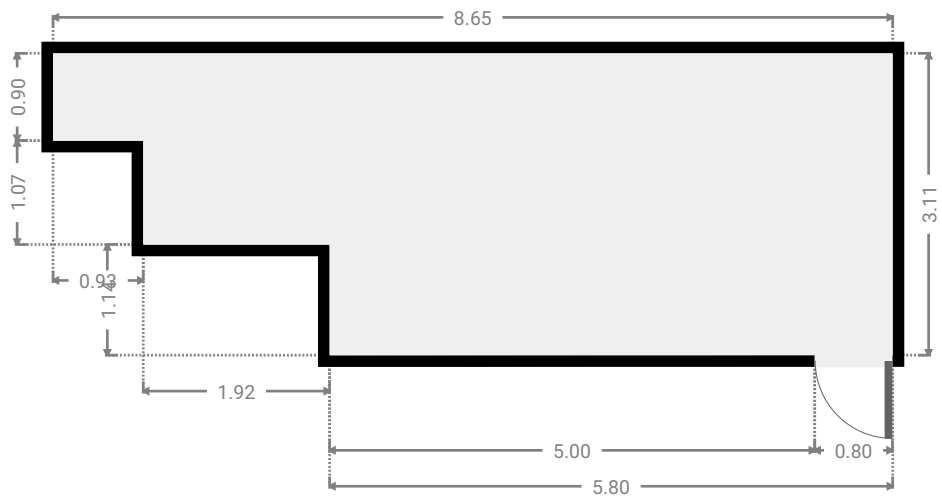
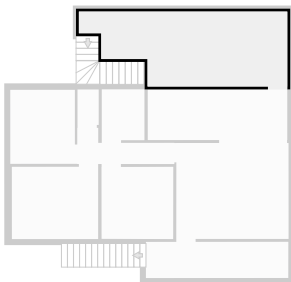

▼ **Other**  
1st Floor

WIDTH: 5.91 m • LENGTH: 1.50 m  
AREA: 8.87 m<sup>2</sup> • PERIMETER: 14.82 m

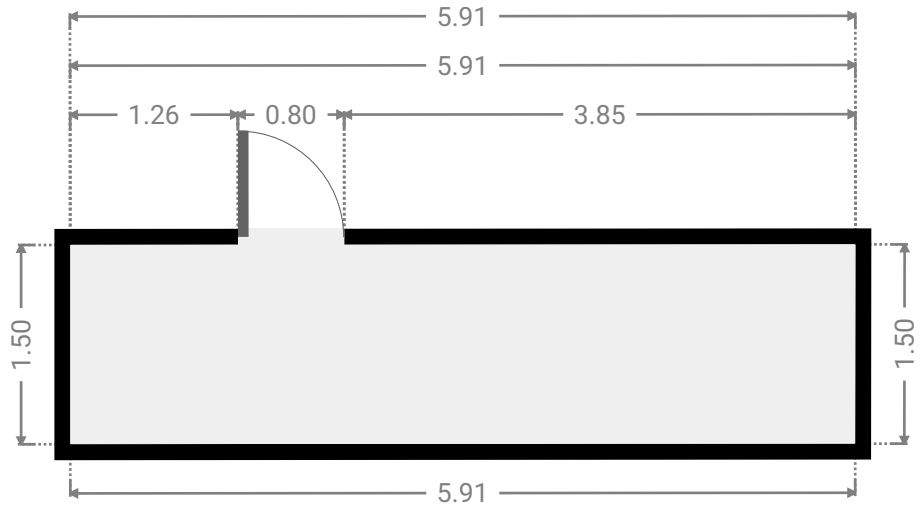
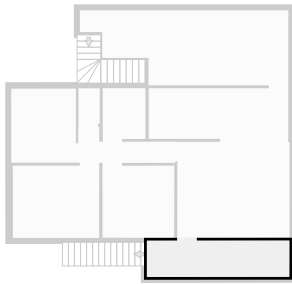

▼ **Toilet**  
1st Floor

WIDTH: 0.88 m • LENGTH: 1.47 m  
AREA: 1.29 m<sup>2</sup> • PERIMETER: 4.70 m

