

# 7 Gilmore Court

Created on  
2021-07-27

Floors  
1

## ▼ Ground Floor



## ▼ Living Room Ground Floor

WIDTH: 7.62 m • LENGTH: 6.04 m  
AREA: 27.18 m<sup>2</sup> • PERIMETER: 27.09 m

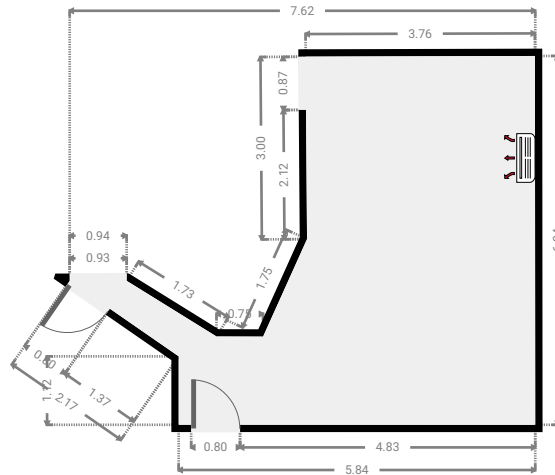
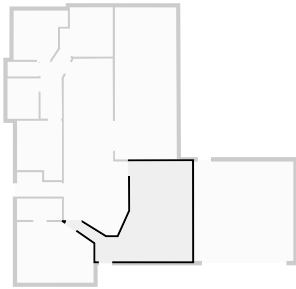

## ▼ Kitchen Ground Floor

WIDTH: 3.89 m • LENGTH: 10.69 m  
AREA: 33.26 m<sup>2</sup> • PERIMETER: 27.46 m

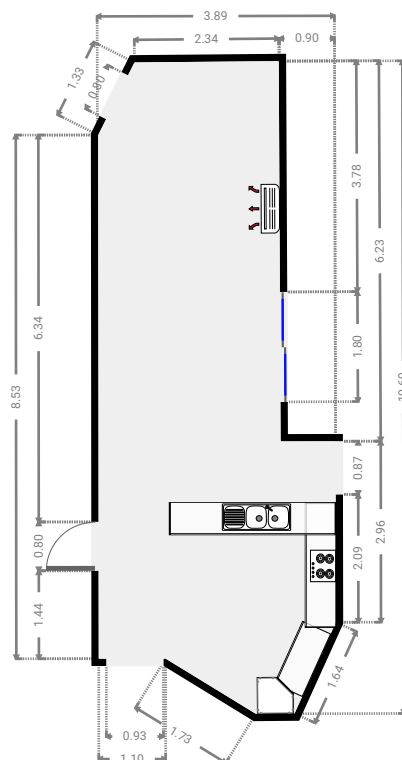
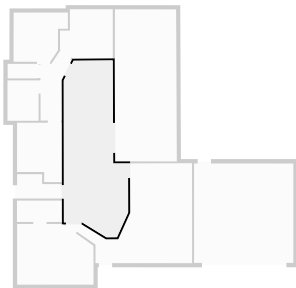

▼ **Master Bedroom**  
Ground Floor

WIDTH: 4.61 m • LENGTH: 3.67 m  
AREA: 15.70 m<sup>2</sup> • PERIMETER: 15.67 m

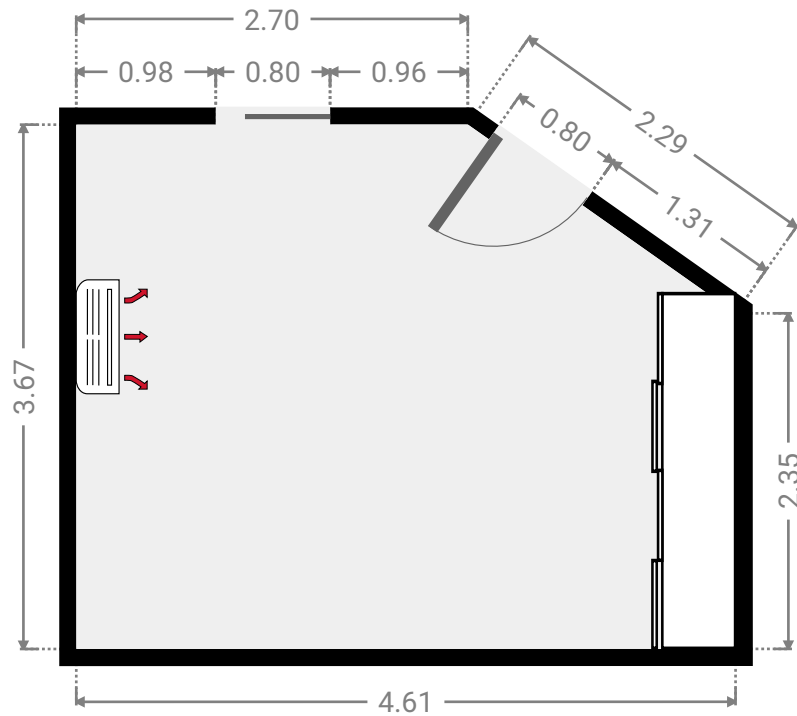
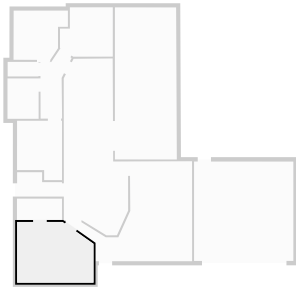

▼ **Bathroom**  
Ground Floor

WIDTH: 2.72 m • LENGTH: 1.29 m  
AREA: 3.51 m<sup>2</sup> • PERIMETER: 8.02 m

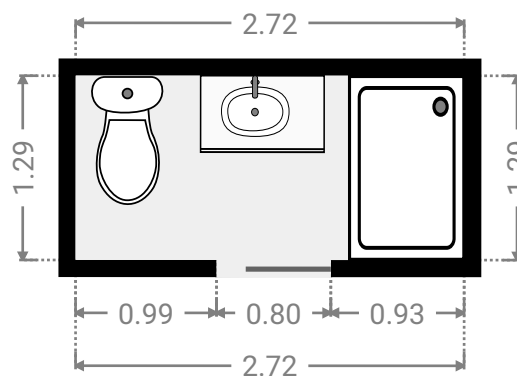
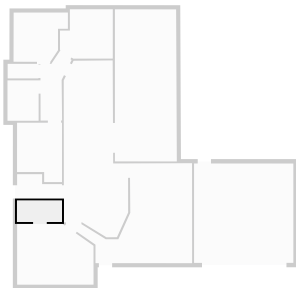

## ▼ Laundry Room Ground Floor

WIDTH: 2.71 m • LENGTH: 1.47 m  
AREA: 3.27 m<sup>2</sup> • PERIMETER: 8.36 m

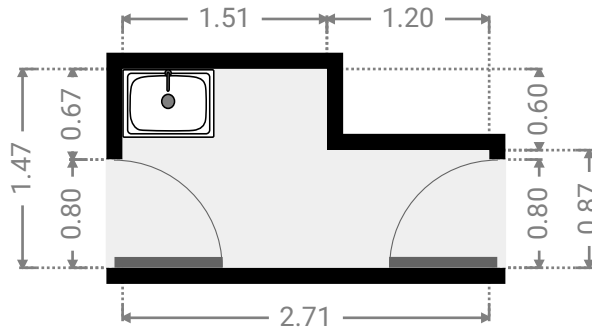
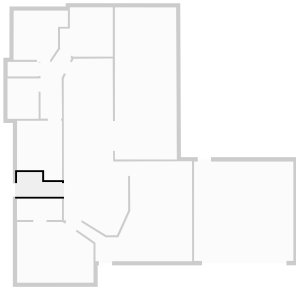

## ▼ Bedroom Ground Floor

WIDTH: 2.72 m • LENGTH: 3.59 m  
AREA: 8.76 m<sup>2</sup> • PERIMETER: 12.61 m

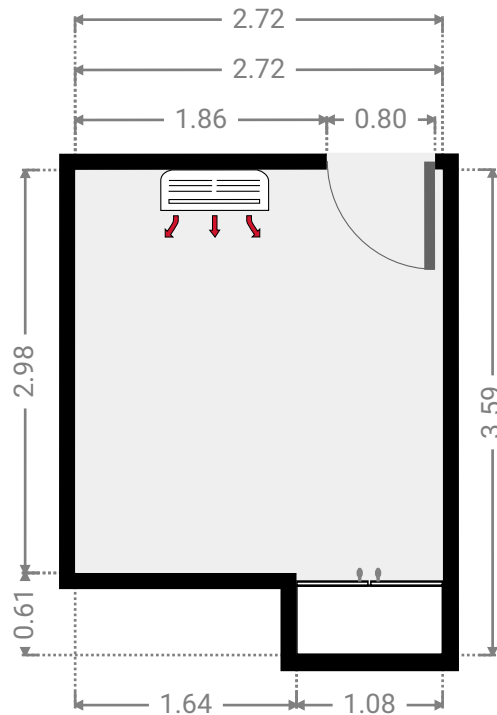
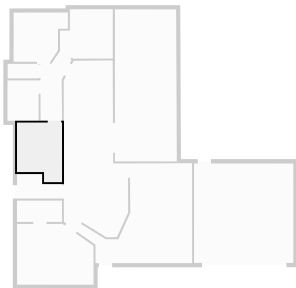

▼ **Hall**  
Ground Floor

WIDTH: 1.92 m • LENGTH: 4.15 m  
AREA: 5.15 m<sup>2</sup> • PERIMETER: 10.94 m

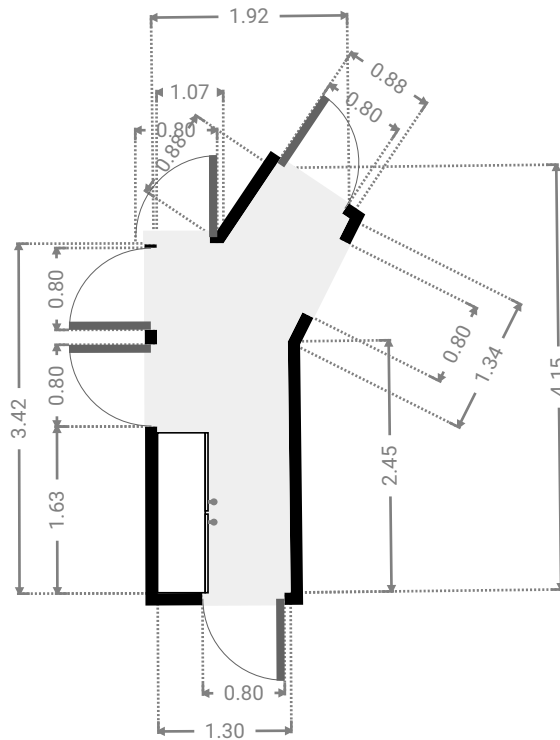
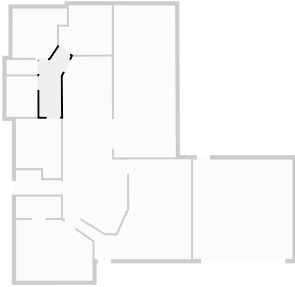

▼ **Bathroom**  
Ground Floor

WIDTH: 1.88 m • LENGTH: 2.44 m  
AREA: 4.59 m<sup>2</sup> • PERIMETER: 8.64 m

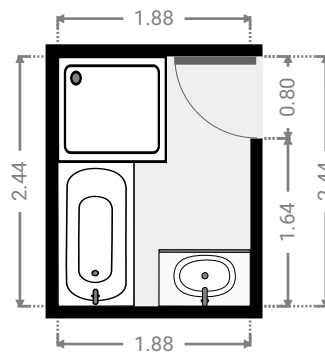
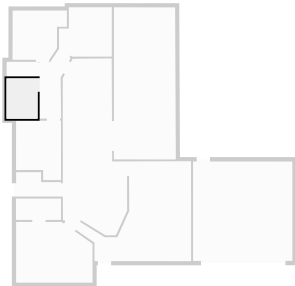

▼ Toilet  
Ground Floor

WIDTH: 1.86 m • LENGTH: 0.88 m  
AREA: 1.64 m<sup>2</sup> • PERIMETER: 5.48 m

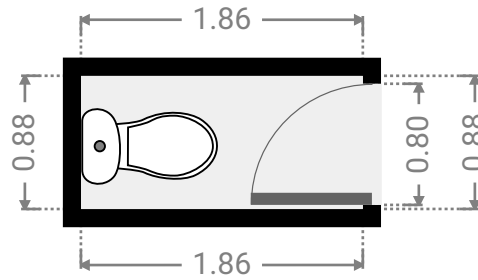
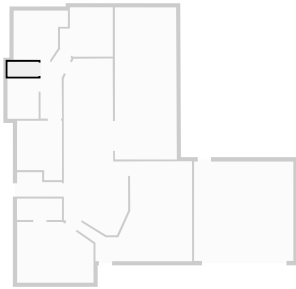

▼ Bedroom  
Ground Floor

WIDTH: 3.29 m • LENGTH: 2.98 m  
AREA: 8.41 m<sup>2</sup> • PERIMETER: 12.19 m

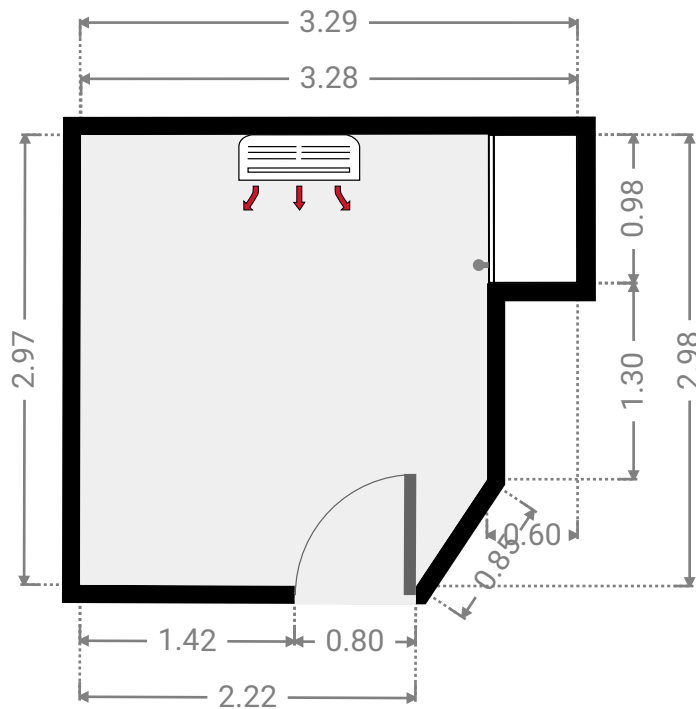
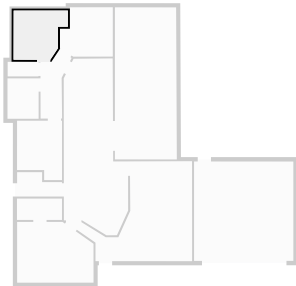

## ▼ Bedroom Ground Floor

WIDTH: 3.20 m • LENGTH: 2.98 m  
AREA: 8.53 m<sup>2</sup> • PERIMETER: 11.97 m

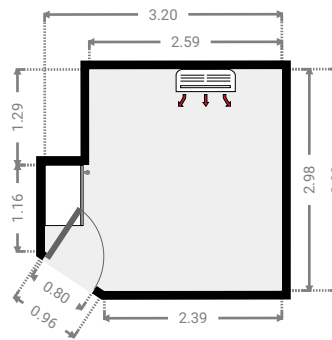
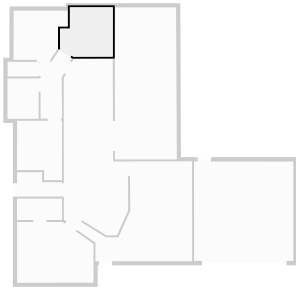

## ▼ Other Ground Floor

WIDTH: 3.74 m • LENGTH: 9.21 m  
AREA: 34.19 m<sup>2</sup> • PERIMETER: 25.82 m

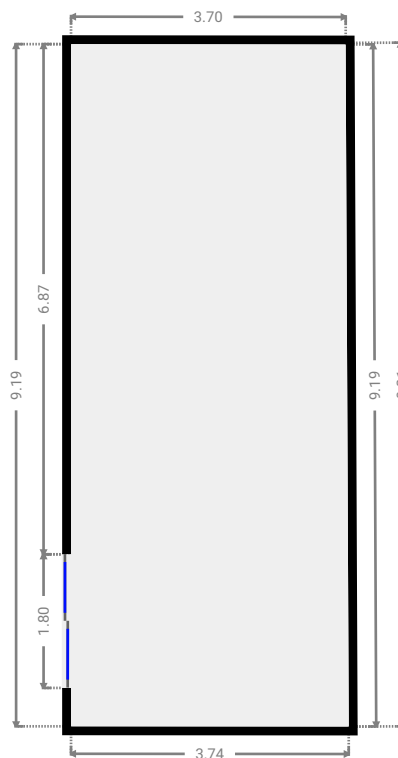
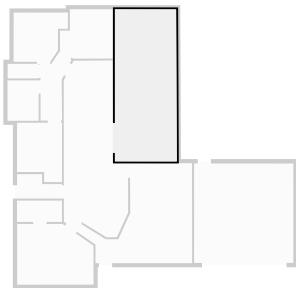



## ▼ Garage Ground Floor

WIDTH: 6.00 m • LENGTH: 6.01 m  
AREA: 36.02 m<sup>2</sup> • PERIMETER: 24.01 m

