

7 Elwing STREET

SUBMITTED BY

Ray White Rockhampton Casey
stockers@cqoz.com

CREATED ON

2022-09-12

Floors

2

▼ Ground Floor

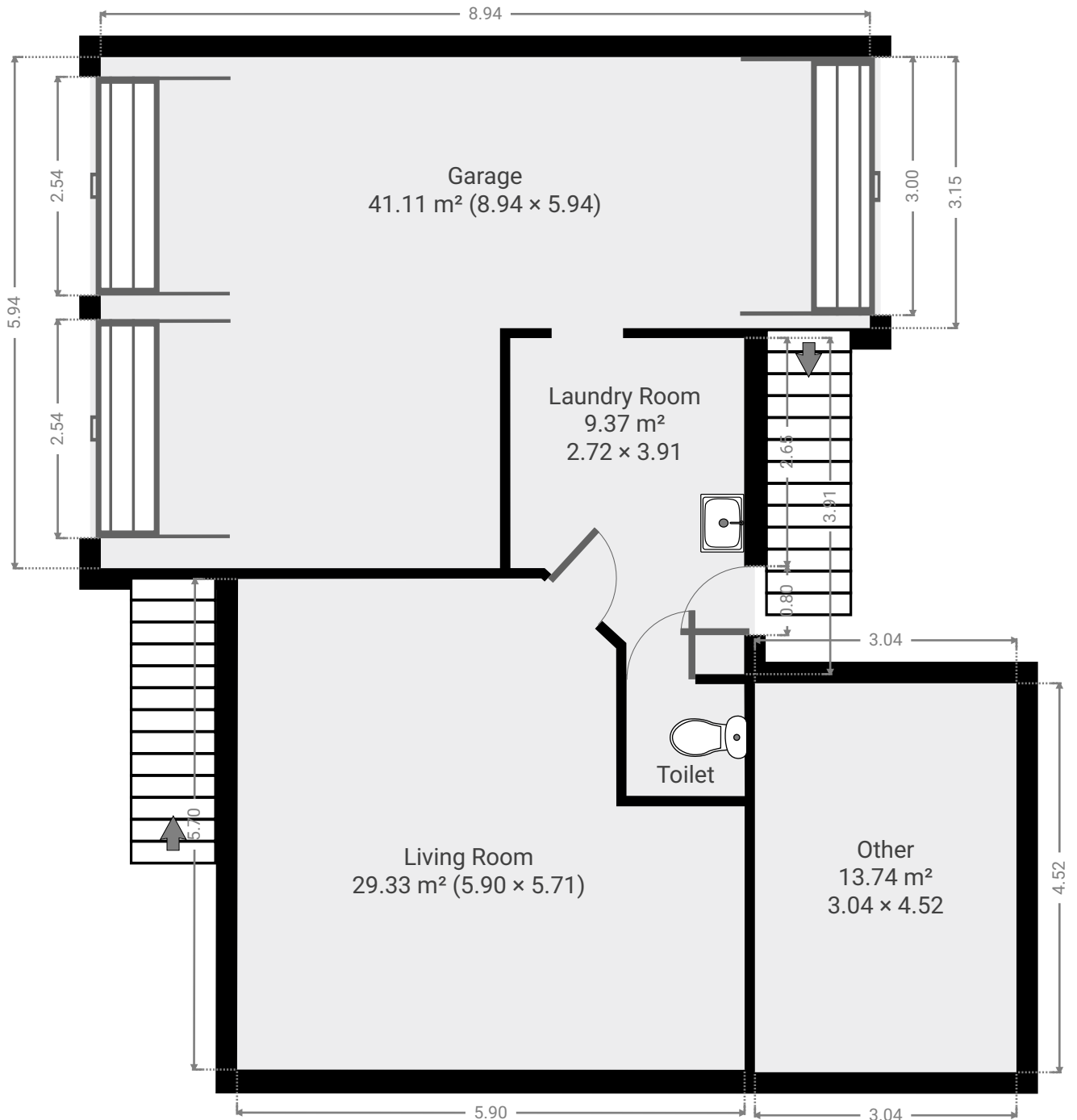

▼ Garage Ground Floor

WIDTH: 5.94 m • LENGTH: 8.94 m
AREA: 41.11 m² • PERIMETER: 29.76 m

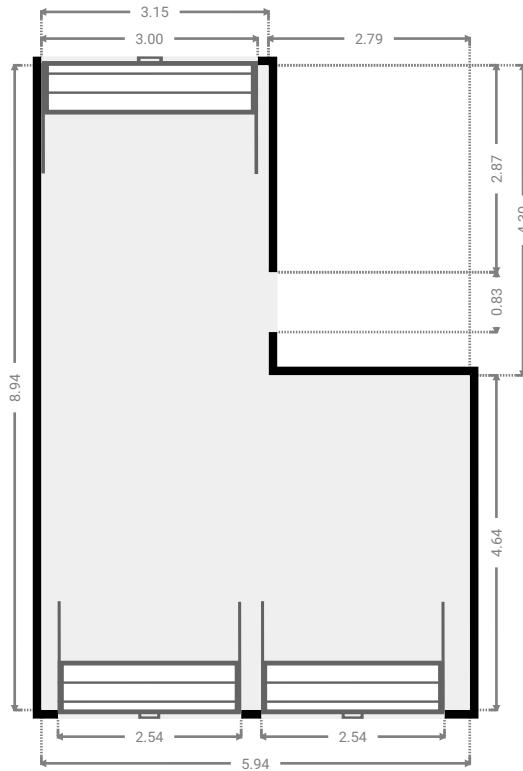
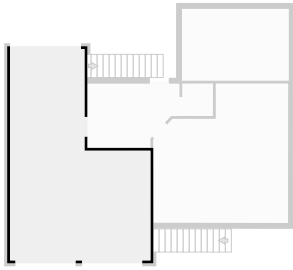

▼ Laundry Room Ground Floor

WIDTH: 3.91 m • LENGTH: 2.72 m
AREA: 9.37 m² • PERIMETER: 12.72 m

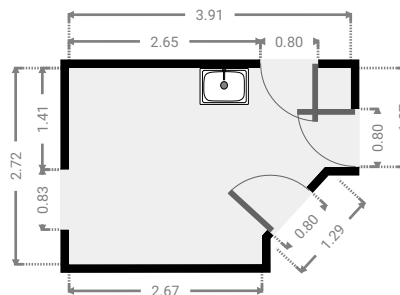
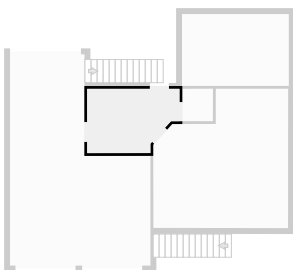

▼ **Living Room**
Ground Floor

WIDTH: 5.71 m • LENGTH: 5.90 m
AREA: 29.33 m² • PERIMETER: 22.71 m

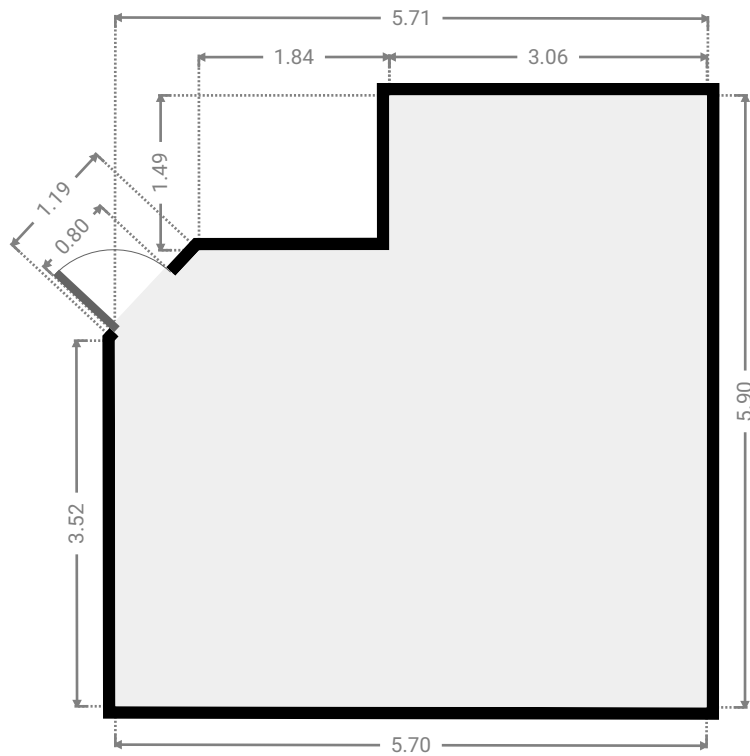
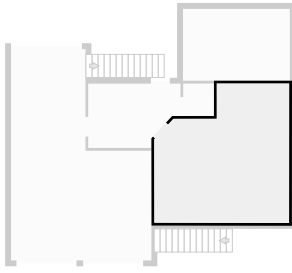

▼ **Other**
Ground Floor

WIDTH: 4.52 m • LENGTH: 3.04 m
AREA: 13.74 m² • PERIMETER: 15.12 m

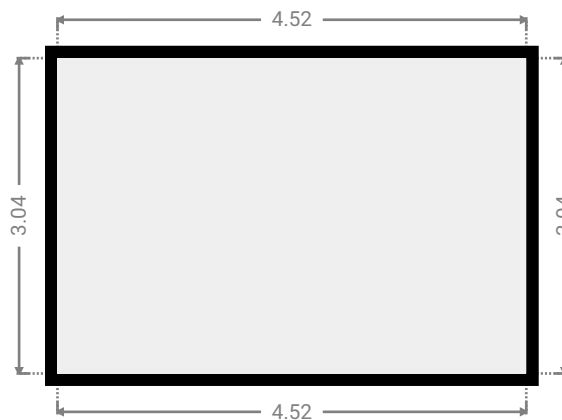
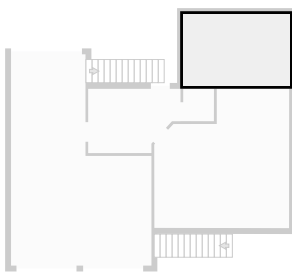

▼ Toilet
Ground Floor

WIDTH: 1.30 m • LENGTH: 1.38 m
AREA: 1.78 m² • PERIMETER: 5.35 m

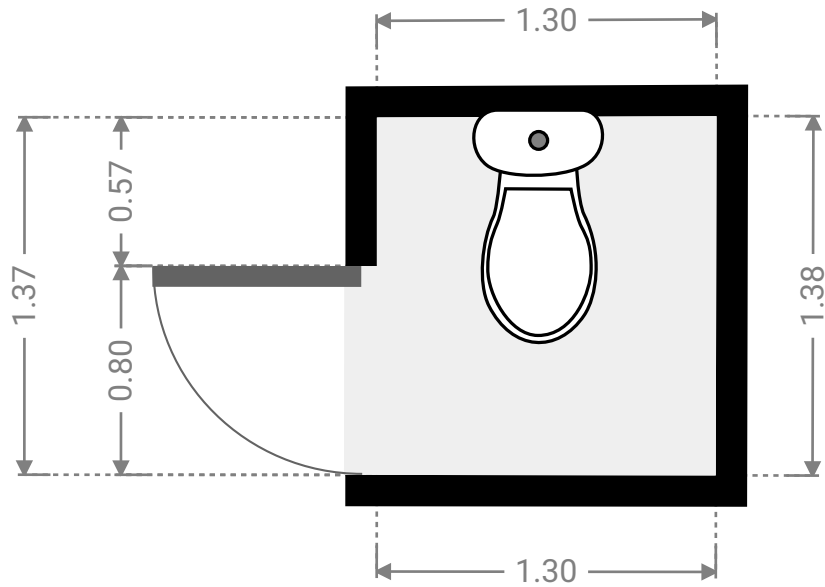
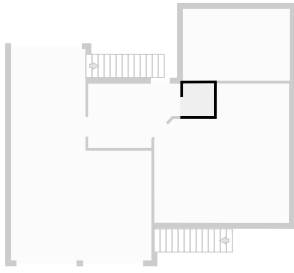

▼ 1st Floor

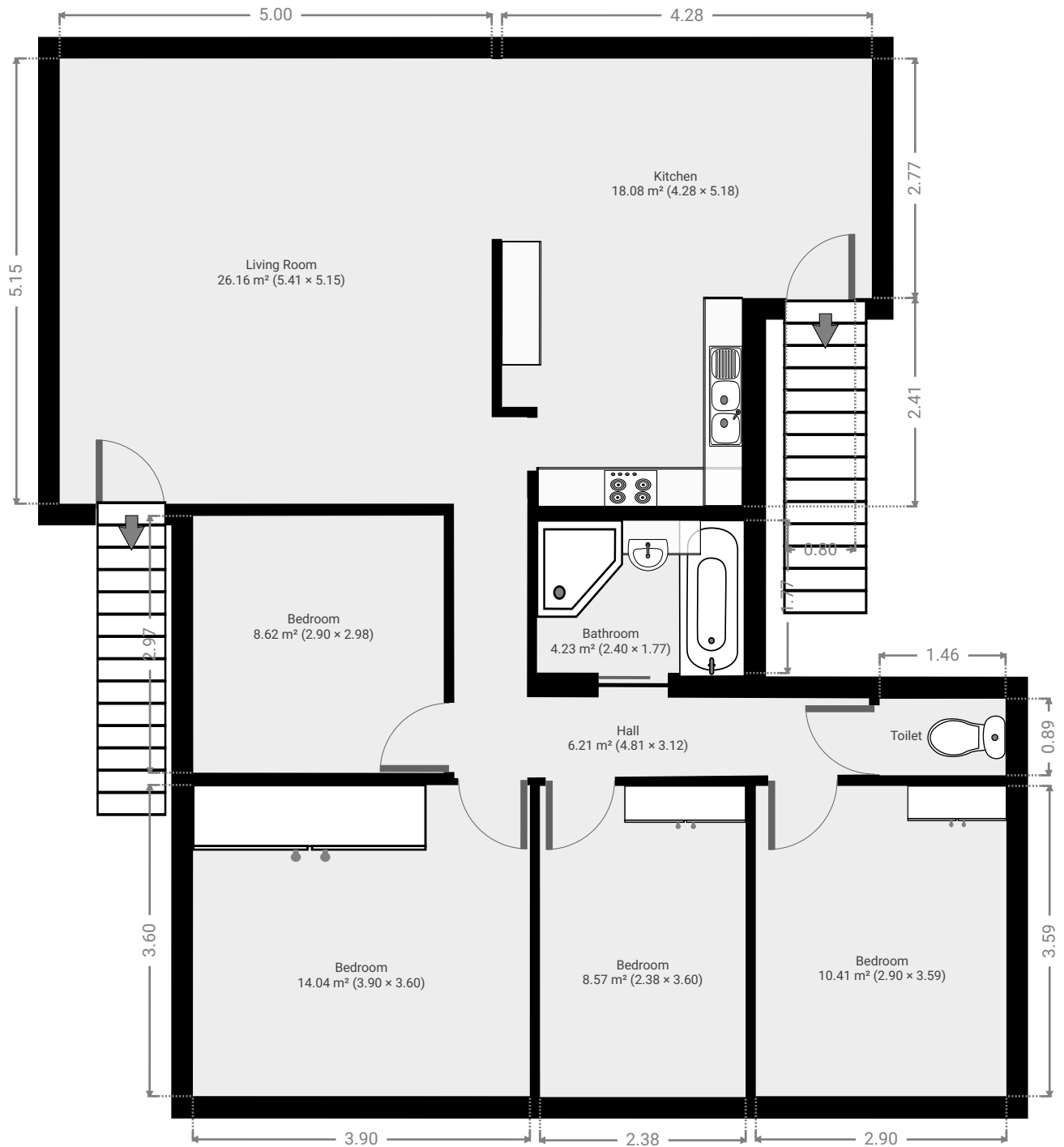

▼ **Bathroom**
1st Floor

WIDTH: 1.77 m • LENGTH: 2.40 m
AREA: 4.23 m² • PERIMETER: 8.33 m

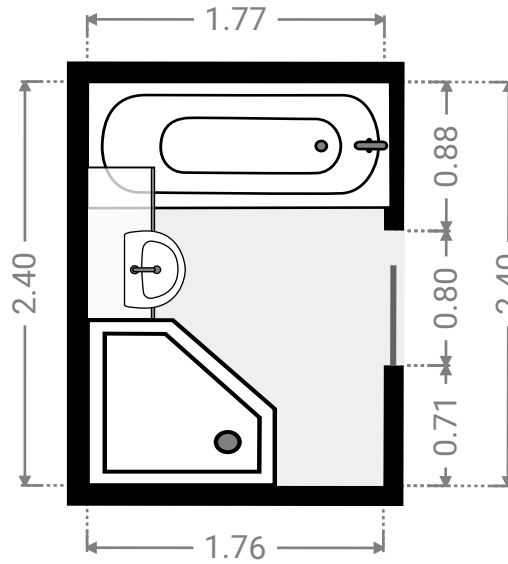
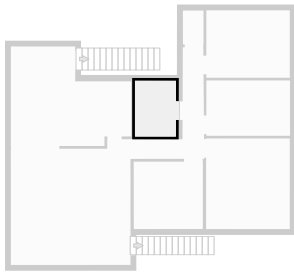

▼ **Bedroom**
1st Floor

WIDTH: 2.98 m • LENGTH: 2.90 m
AREA: 8.62 m² • PERIMETER: 11.75 m

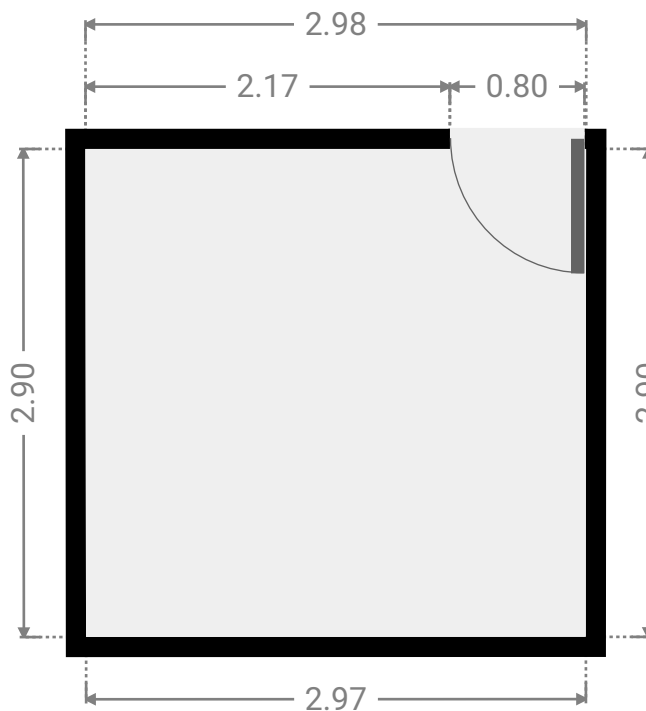
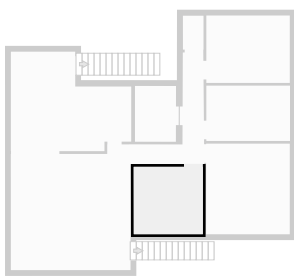

▼ **Bedroom**
1st Floor

WIDTH: 3.60 m • LENGTH: 3.90 m
AREA: 14.04 m² • PERIMETER: 15.00 m

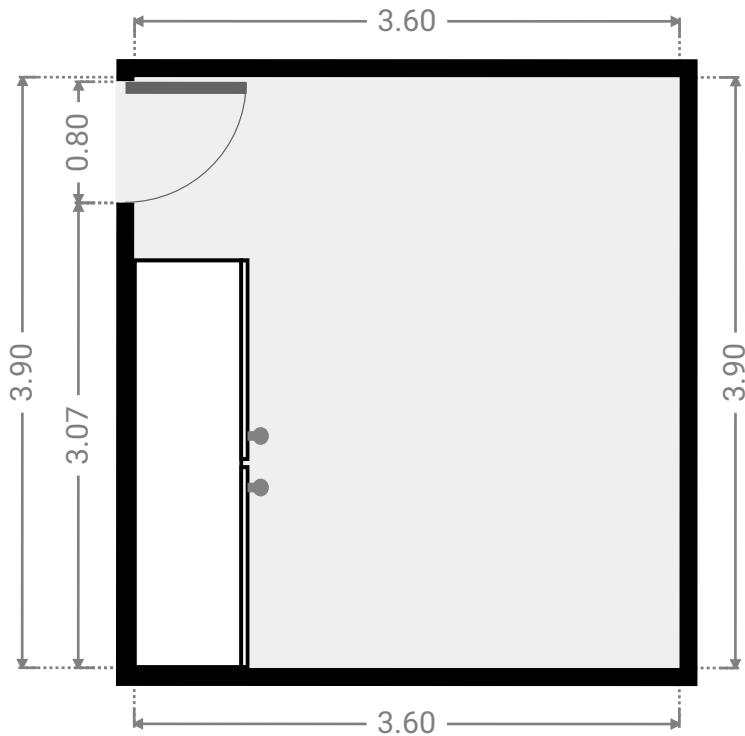
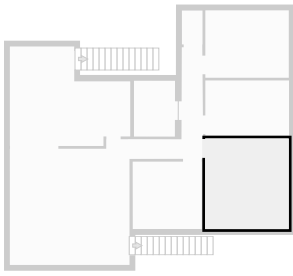

▼ **Bedroom**
1st Floor

WIDTH: 3.60 m • LENGTH: 2.38 m
AREA: 8.57 m² • PERIMETER: 11.96 m

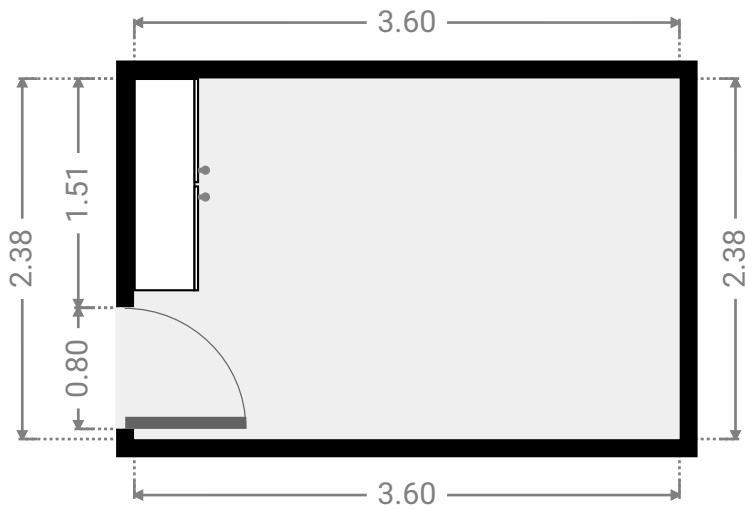
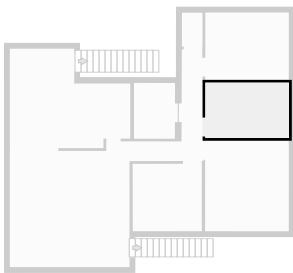

▼ Bedroom 1st Floor

WIDTH: 3.59 m • LENGTH: 2.90 m
AREA: 10.41 m² • PERIMETER: 12.98 m

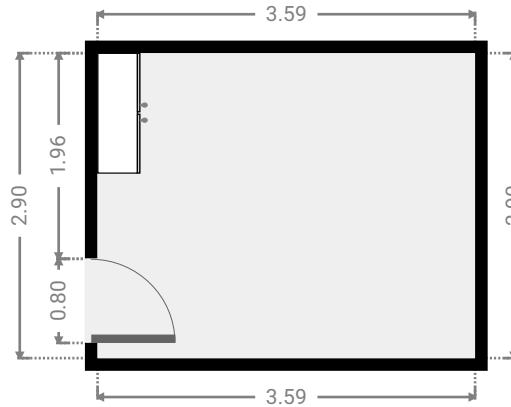
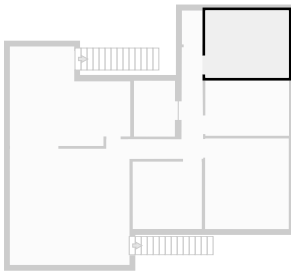

▼ Hall 1st Floor

WIDTH: 3.12 m • LENGTH: 4.81 m
AREA: 6.21 m² • PERIMETER: 15.79 m

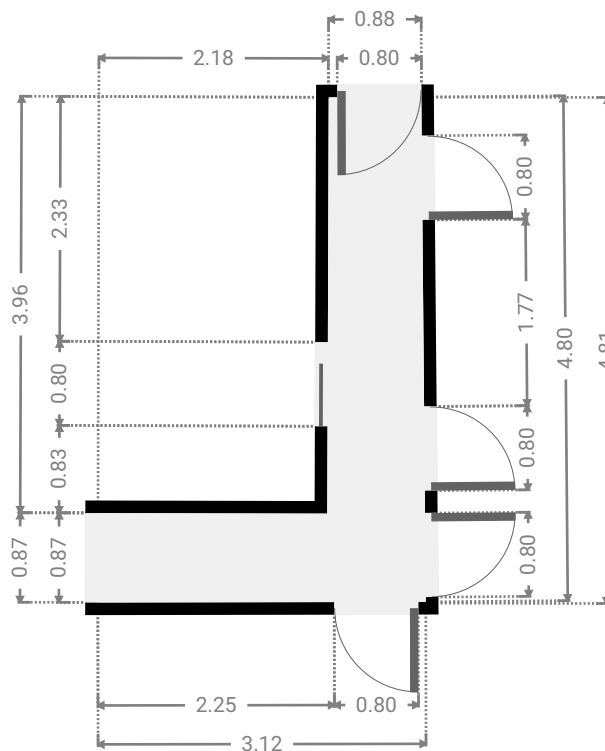
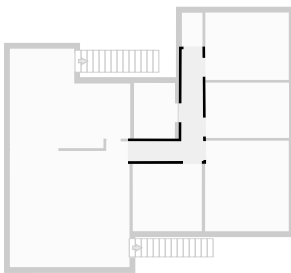

▼ Kitchen 1st Floor

WIDTH: 5.18 m • LENGTH: 4.28 m
AREA: 18.08 m² • PERIMETER: 18.92 m

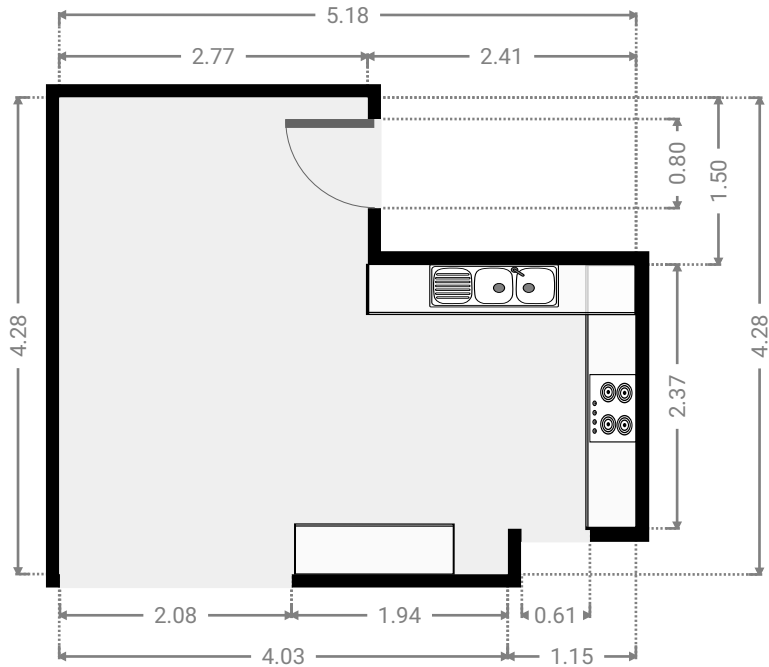
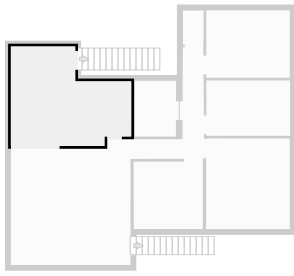

▼ Living Room 1st Floor

WIDTH: 5.15 m • LENGTH: 5.41 m
AREA: 26.16 m² • PERIMETER: 21.12 m

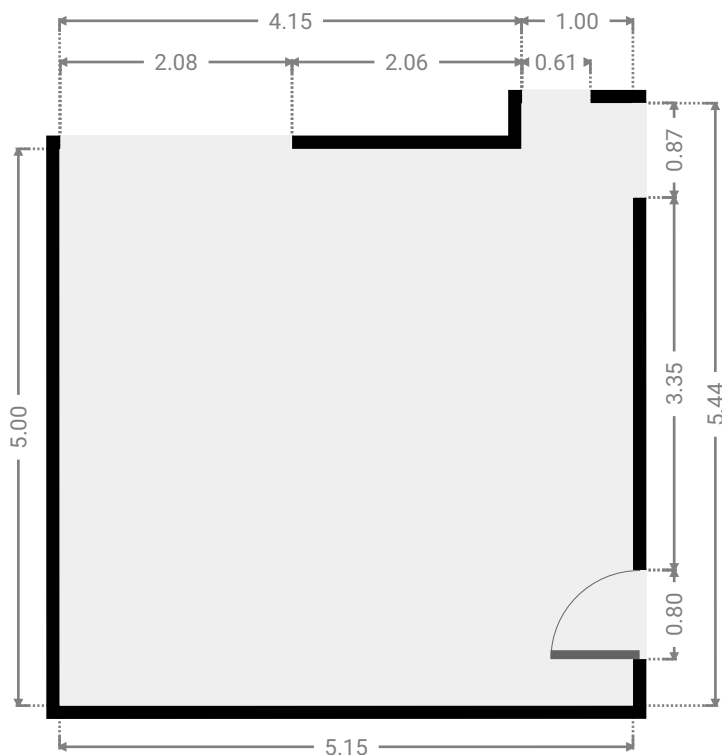
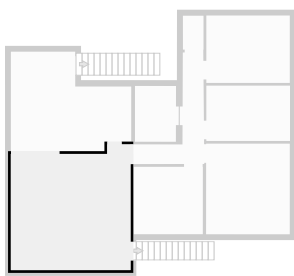

▼ Toilet
1st Floor

WIDTH: 0.89 m • LENGTH: 1.46 m
AREA: 1.29 m² • PERIMETER: 4.69 m

