

# 7 Bryce Court

## Ground Floor

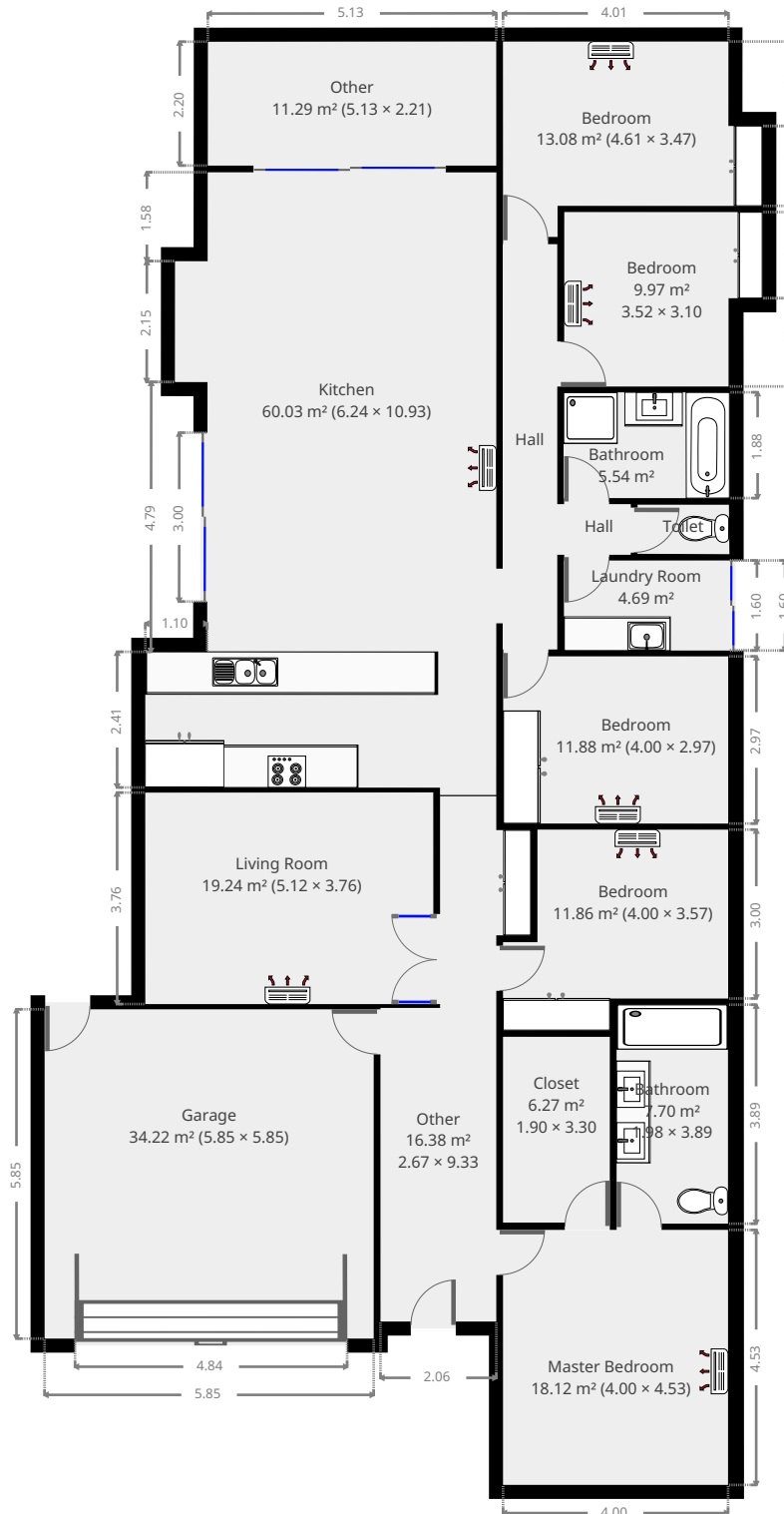

THIS FLOORPLAN IS PROVIDED WITHOUT WARRANTY OF ANY KIND. SENSOPIA DISCLAIMS ANY WARRANTY INCLUDING, WITHOUT LIMITATION, SATISFACTORY QUALITY OR ACCURACY OF DIMENSIONS.



# 7 Bryce Court

## Hall

Width: 0.97 m  
 Length: 7.20 m  
 Area: 6.98 m<sup>2</sup>  
 Perimeter: 16.34 m

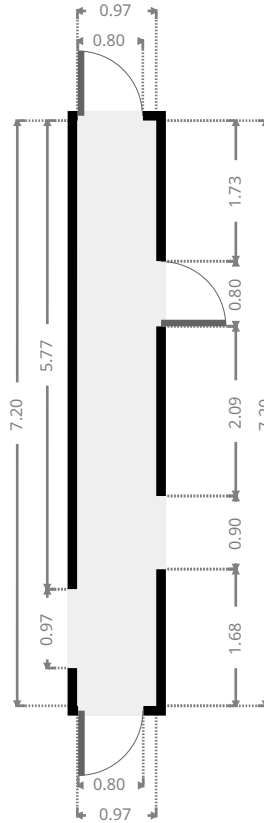

## Other

Width: 2.21 m  
 Length: 5.13 m  
 Area: 11.29 m<sup>2</sup>  
 Perimeter: 14.66 m

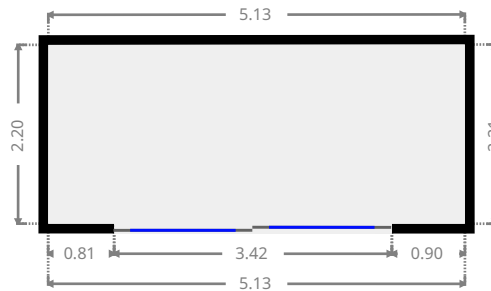
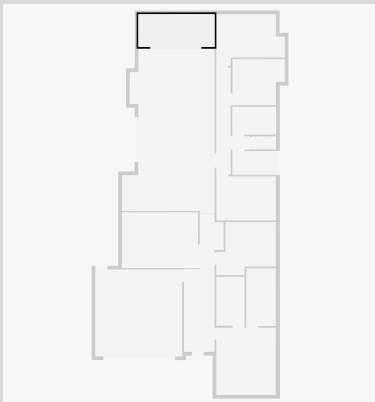

# 7 Bryce Court

## Bedroom

Width: 3.47 m  
 Length: 4.61 m  
 Area: 13.08 m<sup>2</sup>  
 Perimeter: 16.16 m

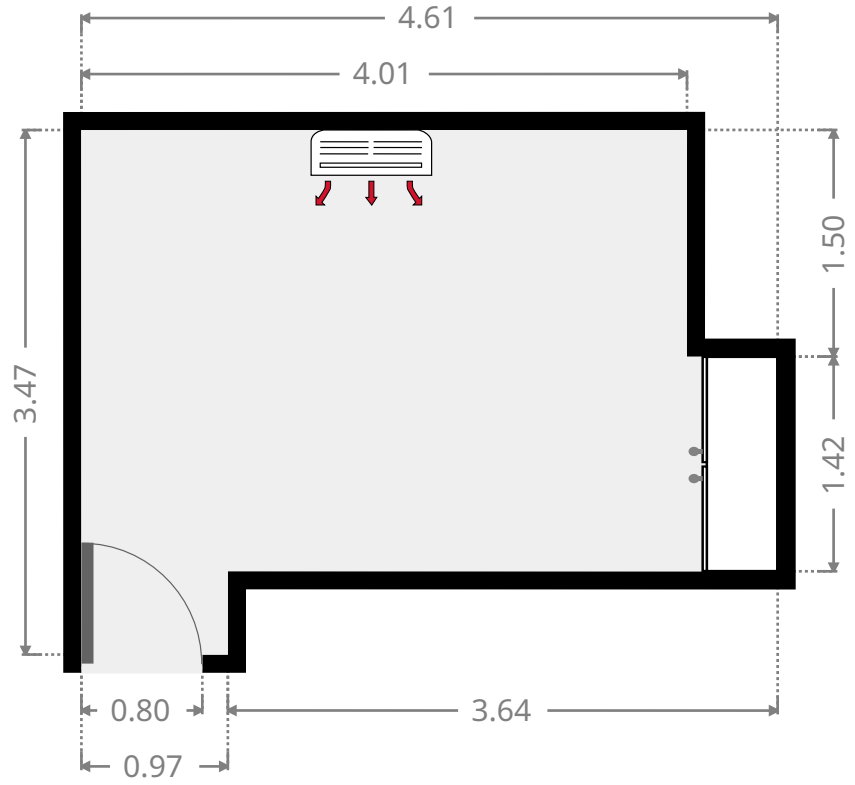
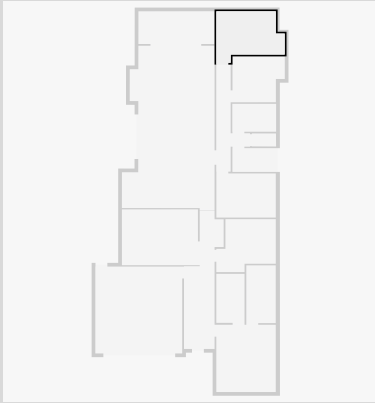

## Bedroom

Width: 3.10 m  
 Length: 3.52 m  
 Area: 9.97 m<sup>2</sup>  
 Perimeter: 13.24 m

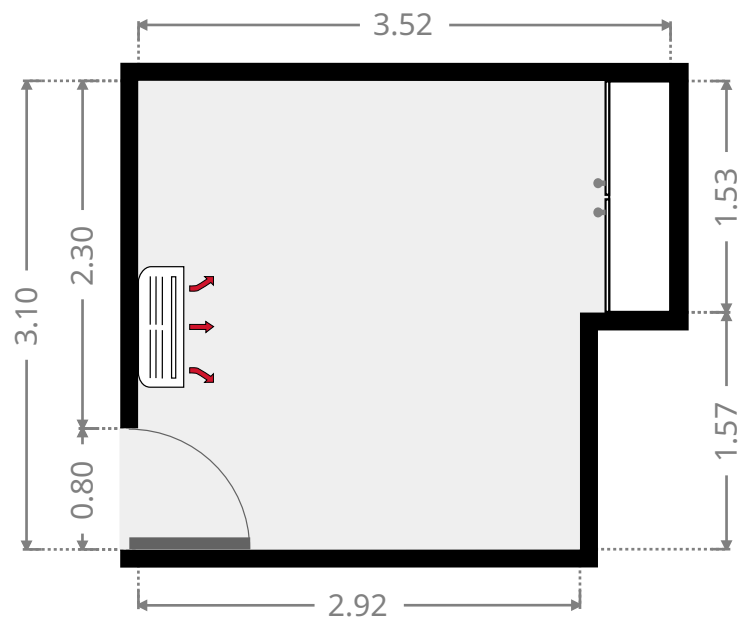
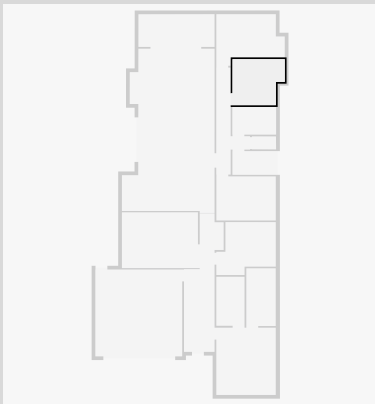

THIS FLOORPLAN IS PROVIDED WITHOUT WARRANTY OF ANY KIND. SENSOPIA DISCLAIMS ANY WARRANTY INCLUDING, WITHOUT LIMITATION, SATISFACTORY QUALITY OR ACCURACY OF DIMENSIONS.

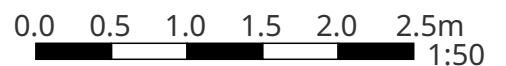

# 7 Bryce Court

## Bathroom

Width: 1.88 m  
 Length: 2.95 m  
 Area: 5.54 m<sup>2</sup>  
 Perimeter: 9.66 m

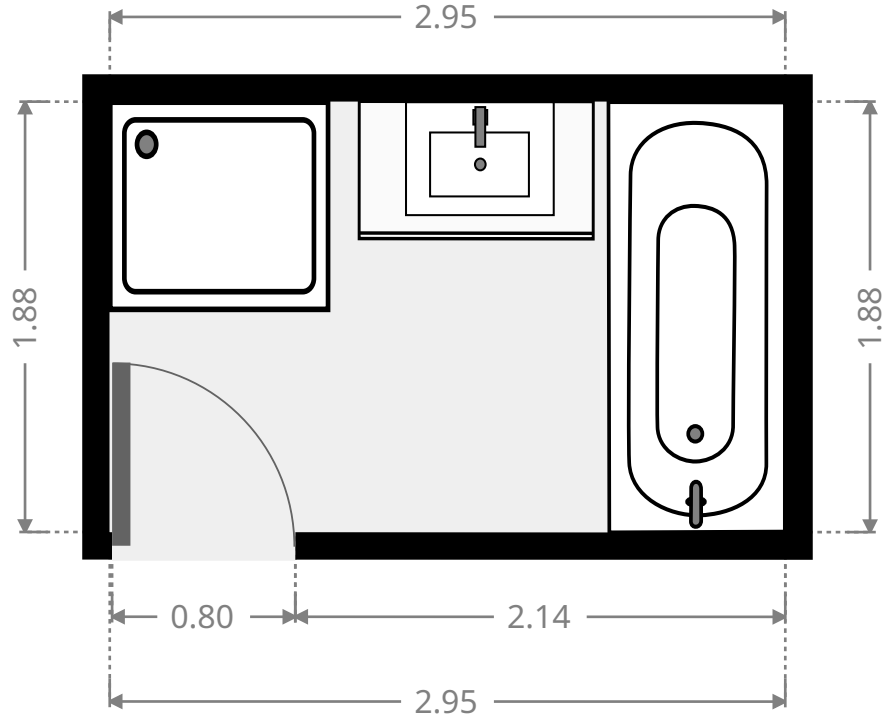
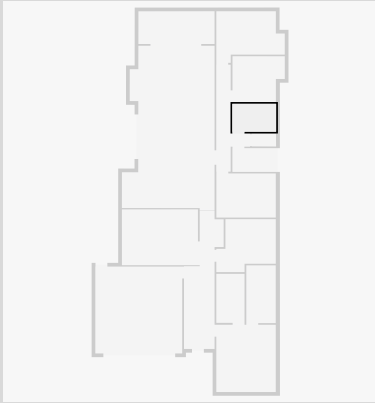

## Toilet / Half Bath

Width: 0.88 m  
 Length: 1.64 m  
 Area: 1.42 m<sup>2</sup>  
 Perimeter: 5.01 m

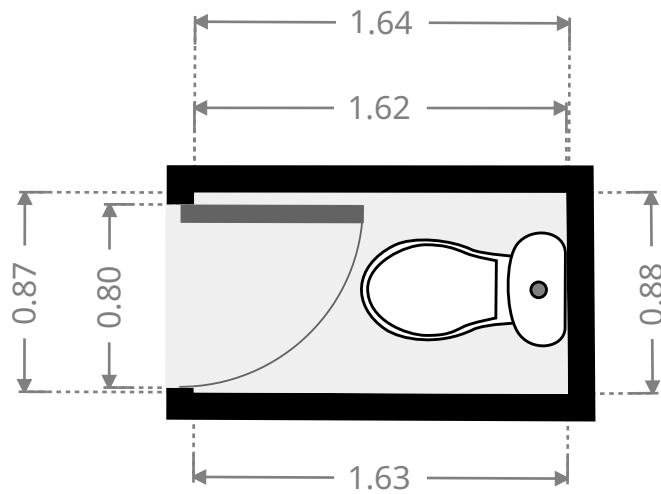
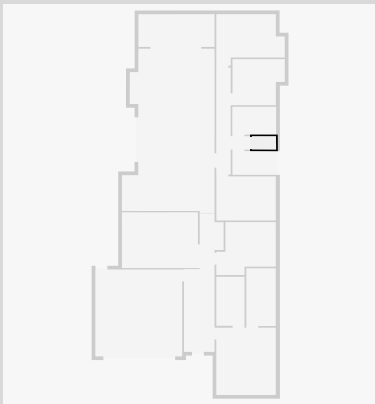

THIS FLOORPLAN IS PROVIDED WITHOUT WARRANTY OF ANY KIND. SENSOPIA DISCLAIMS ANY WARRANTY INCLUDING, WITHOUT LIMITATION, SATISFACTORY QUALITY OR ACCURACY OF DIMENSIONS.

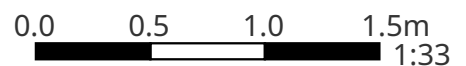

# 7 Bryce Court

## Hall

Width: 0.90 m  
 Length: 1.19 m  
 Area: 1.07 m<sup>2</sup>  
 Perimeter: 4.18 m

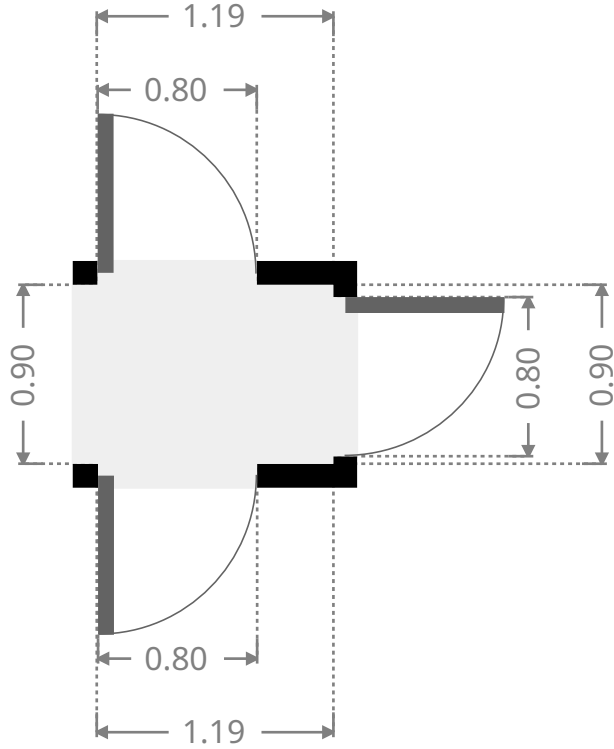
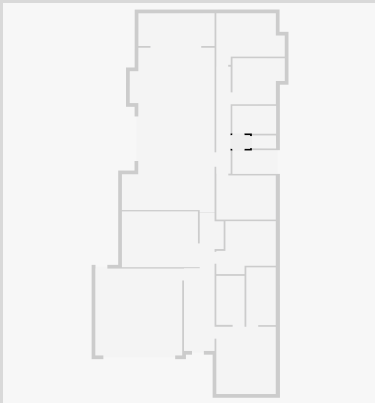

## Laundry Room

Width: 1.60 m  
 Length: 2.93 m  
 Area: 4.69 m<sup>2</sup>  
 Perimeter: 9.06 m

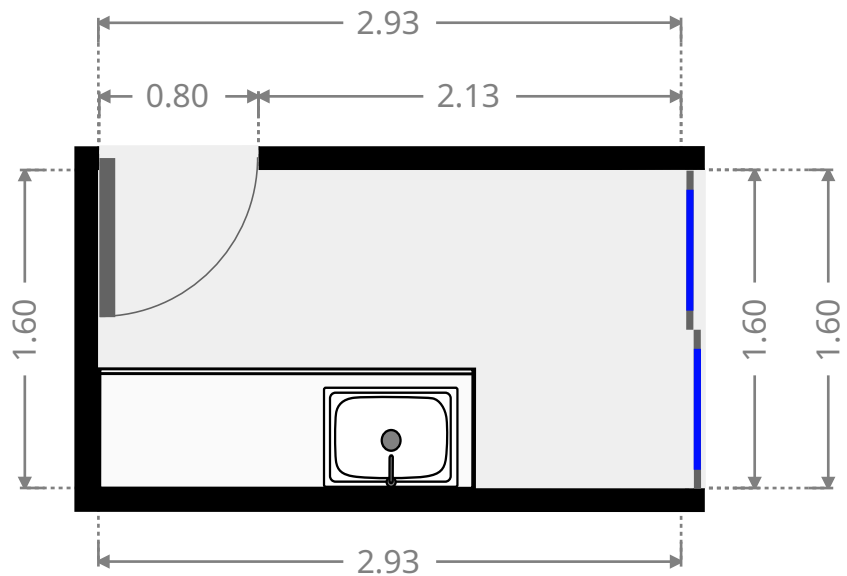
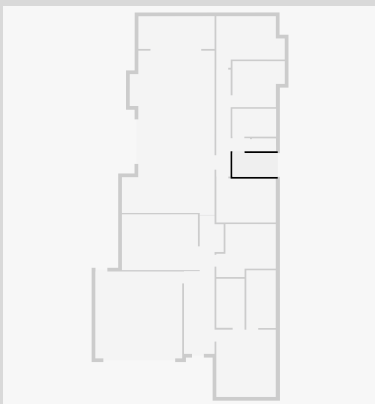

THIS FLOORPLAN IS PROVIDED WITHOUT WARRANTY OF ANY KIND. SENSOPIA DISCLAIMS ANY WARRANTY INCLUDING, WITHOUT LIMITATION, SATISFACTORY QUALITY OR ACCURACY OF DIMENSIONS.

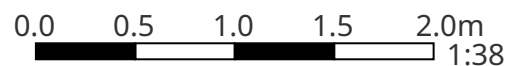

# 7 Bryce Court

## Bedroom

Width: 2.97 m  
 Length: 4.00 m  
 Area: 11.88 m<sup>2</sup>  
 Perimeter: 13.94 m

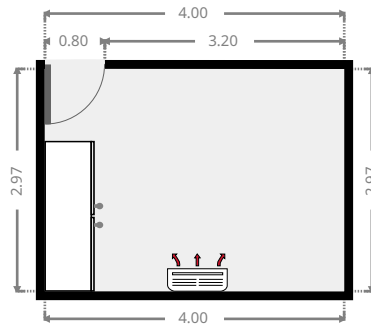
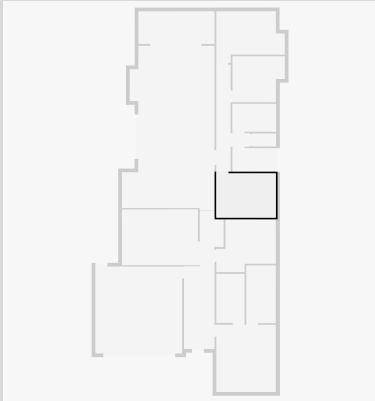

## Other

Width: 2.67 m  
 Length: 9.33 m  
 Area: 16.38 m<sup>2</sup>  
 Perimeter: 24.01 m

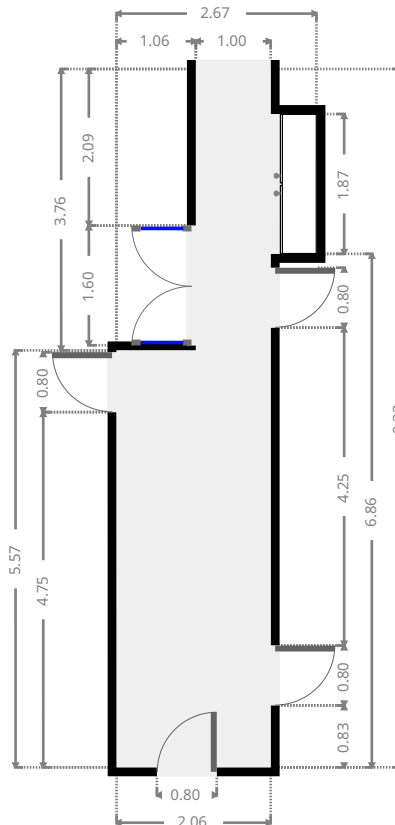
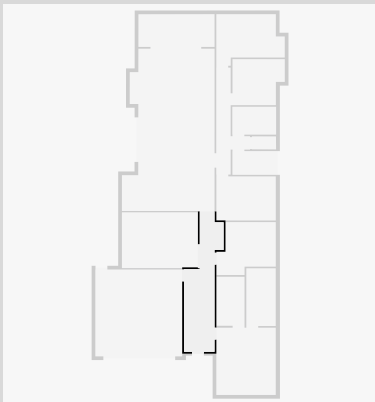

THIS FLOORPLAN IS PROVIDED WITHOUT WARRANTY OF ANY KIND. SENSOPIA DISCLAIMS ANY WARRANTY INCLUDING, WITHOUT LIMITATION, SATISFACTORY QUALITY OR ACCURACY OF DIMENSIONS.

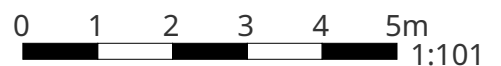

# 7 Bryce Court

## Kitchen

Width: 6.24 m  
 Length: 10.93 m  
 Area: 60.03 m<sup>2</sup>  
 Perimeter: 35.49 m

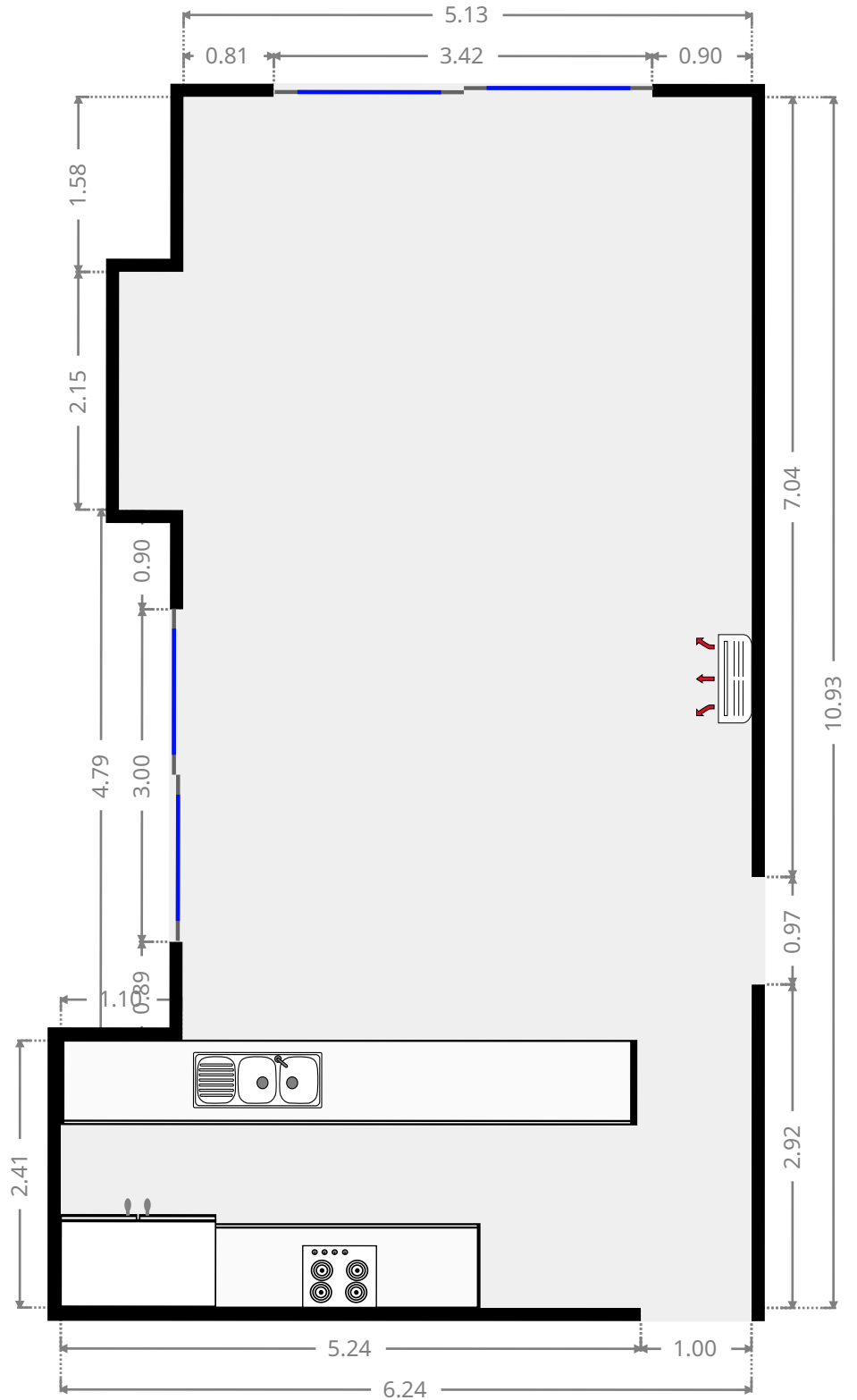
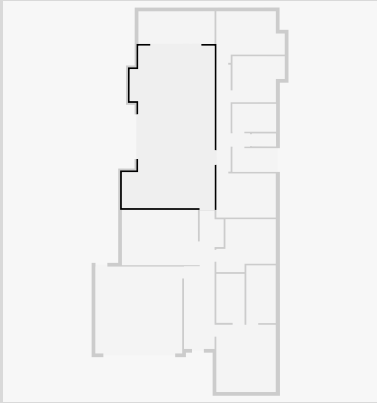

THIS FLOORPLAN IS PROVIDED WITHOUT WARRANTY OF ANY KIND. SENSOPRIA DISCLAIMS ANY WARRANTY INCLUDING, WITHOUT LIMITATION, SATISFACTORY QUALITY OR ACCURACY OF DIMENSIONS.

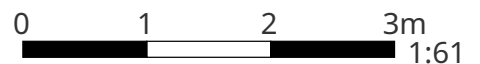

# 7 Bryce Court

## Bedroom

Width: 3.57 m  
 Length: 4.00 m  
 Area: 11.86 m<sup>2</sup>  
 Perimeter: 15.13 m

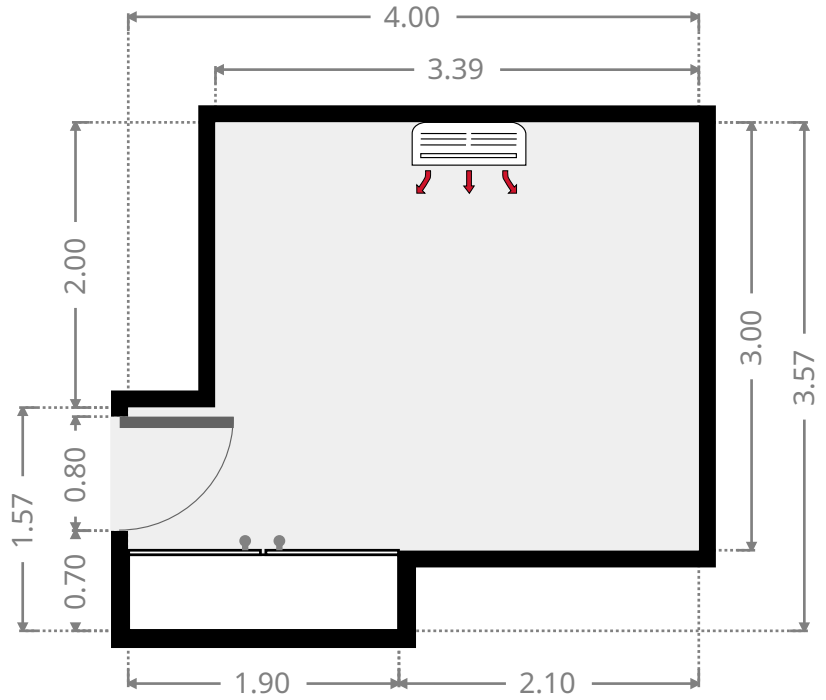

## Living Room

Width: 3.76 m  
 Length: 5.12 m  
 Area: 19.24 m<sup>2</sup>  
 Perimeter: 17.76 m

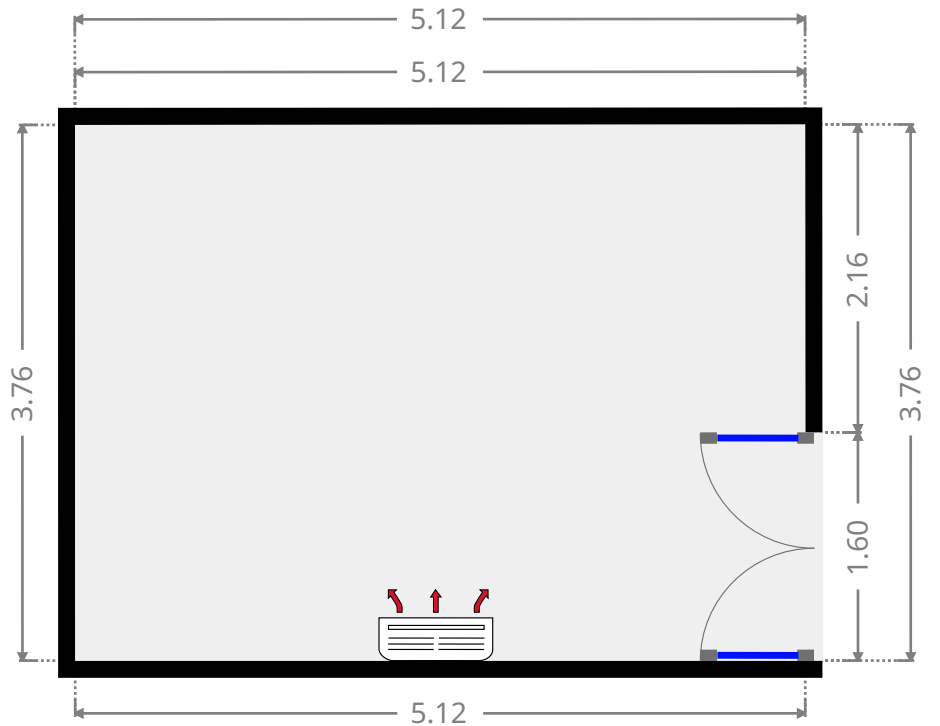
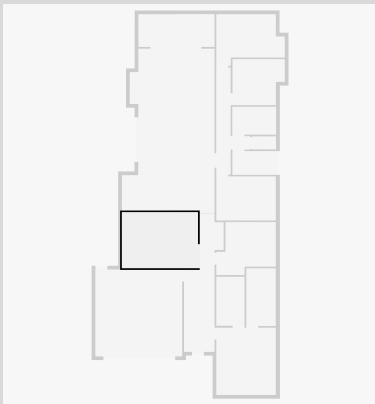

THIS FLOORPLAN IS PROVIDED WITHOUT WARRANTY OF ANY KIND. SENSOPIA DISCLAIMS ANY WARRANTY INCLUDING, WITHOUT LIMITATION, SATISFACTORY QUALITY OR ACCURACY OF DIMENSIONS.

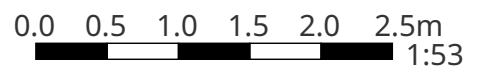



# 7 Bryce Court

## Garage

Width: 5.85 m  
 Length: 5.85 m  
 Area: 34.22 m<sup>2</sup>  
 Perimeter: 23.40 m

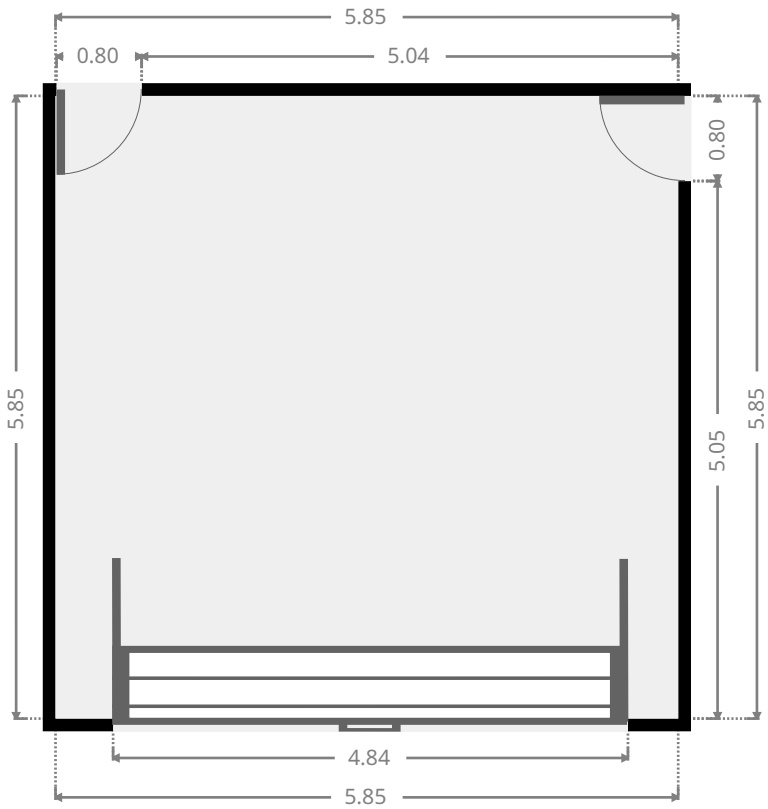
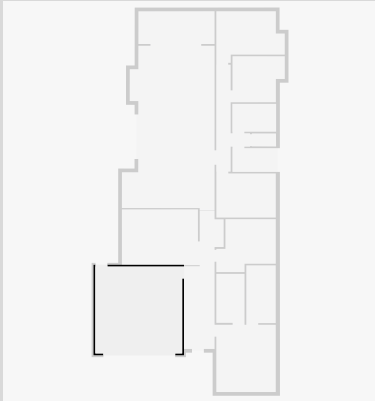

## Closet

Width: 1.90 m  
 Length: 3.30 m  
 Area: 6.27 m<sup>2</sup>  
 Perimeter: 10.40 m

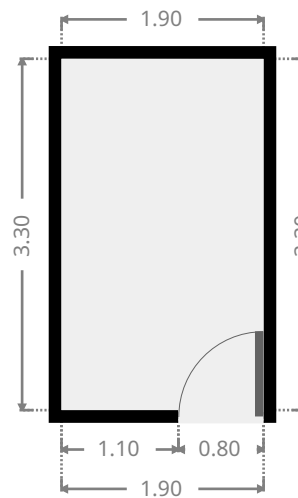
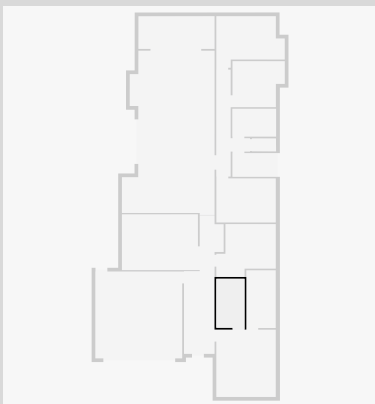

THIS FLOORPLAN IS PROVIDED WITHOUT WARRANTY OF ANY KIND. SENSOPIA DISCLAIMS ANY WARRANTY INCLUDING, WITHOUT LIMITATION, SATISFACTORY QUALITY OR ACCURACY OF DIMENSIONS.

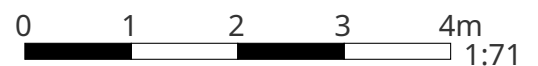

# 7 Bryce Court

## Bathroom

Width: 1.98 m  
 Length: 3.89 m  
 Area: 7.70 m<sup>2</sup>  
 Perimeter: 11.74 m

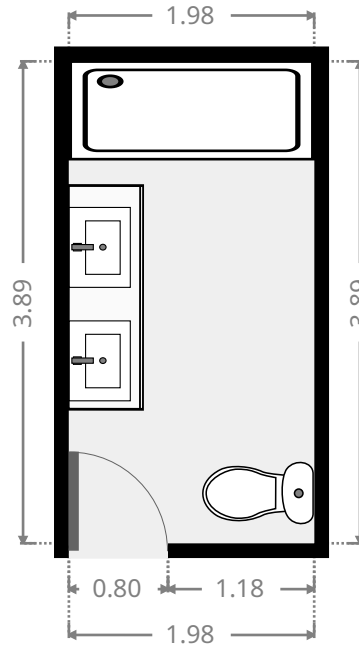
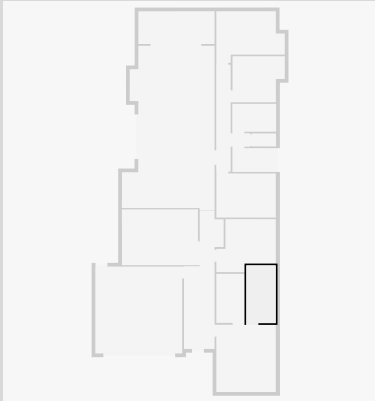

## Master Bedroom

Width: 4.00 m  
 Length: 4.53 m  
 Area: 18.12 m<sup>2</sup>  
 Perimeter: 17.06 m

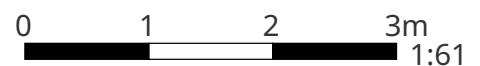
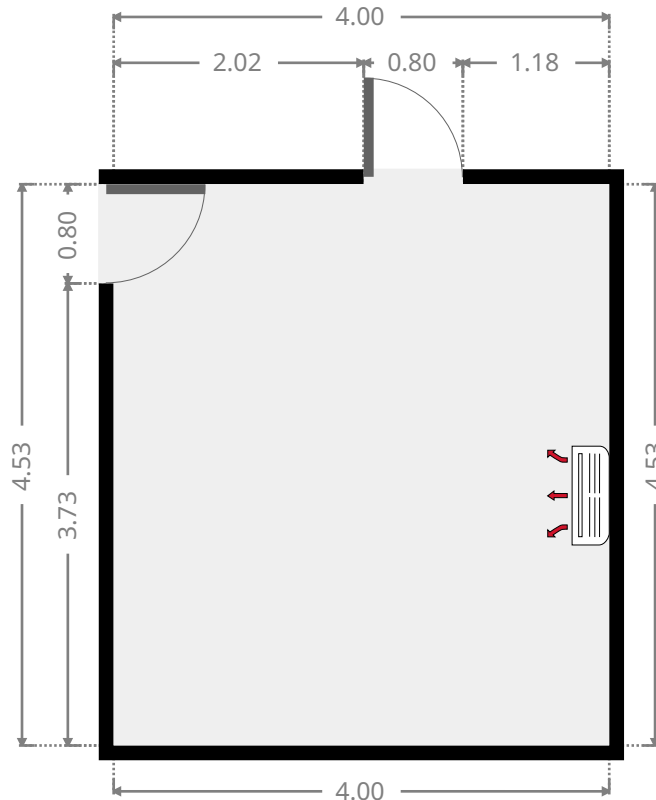
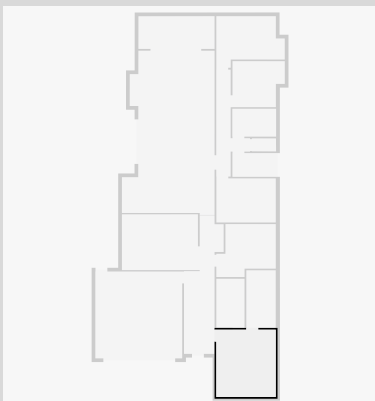

THIS FLOORPLAN IS PROVIDED WITHOUT WARRANTY OF ANY KIND. SENSOPIA DISCLAIMS ANY WARRANTY INCLUDING, WITHOUT LIMITATION, SATISFACTORY QUALITY OR ACCURACY OF DIMENSIONS.