

7 Boree Court

Created on
2017-07-13

Floors 1

▼ Ground Floor

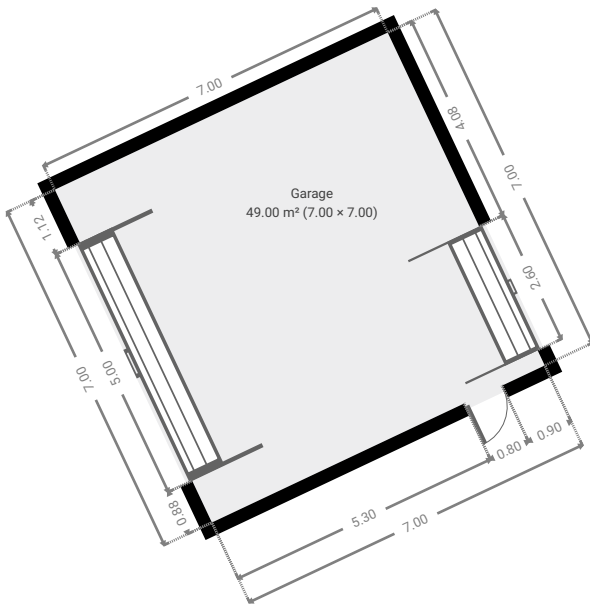

▼ Bedroom

Ground Floor

WIDTH:3.58 m · LENGTH:2.97 m
AREA:10.25 m² · PERIMETER:13.10 m

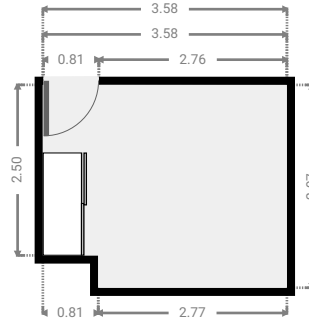
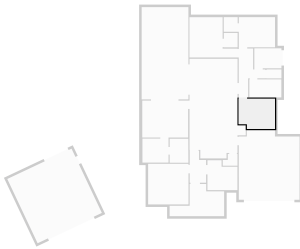

▼ Garage

Ground Floor

WIDTH:7.00 m · LENGTH:7.00 m
AREA:49.00 m² · PERIMETER:28.00 m

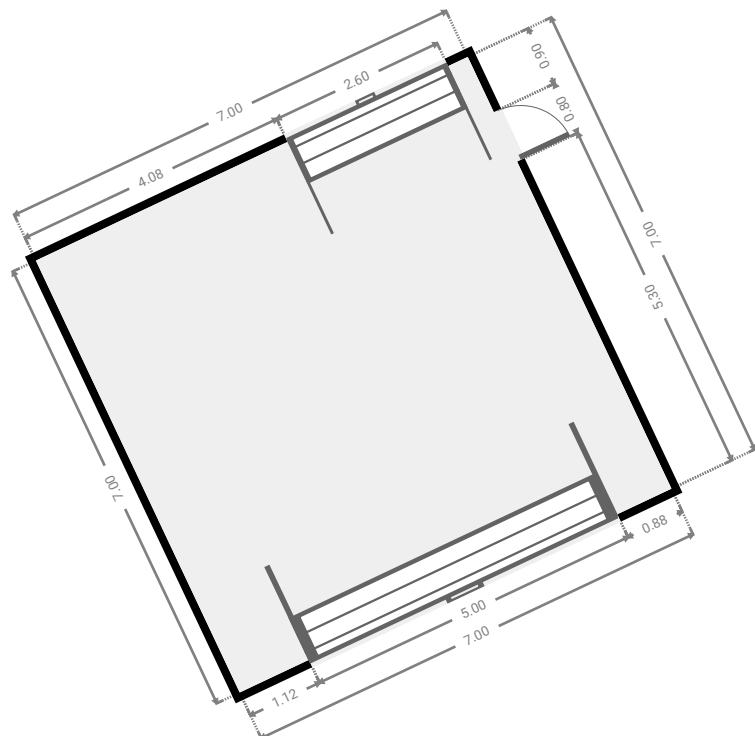

▼ Entry Foyer Ground Floor

WIDTH:5.37 m · LENGTH:3.18 m
AREA:11.52 m² · PERIMETER:17.09 m

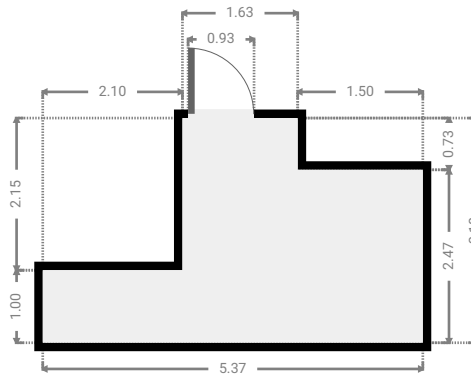

▼ Entertainment Area Ground Floor

WIDTH:4.61 m · LENGTH:9.09 m
AREA:41.87 m² · PERIMETER:27.39 m

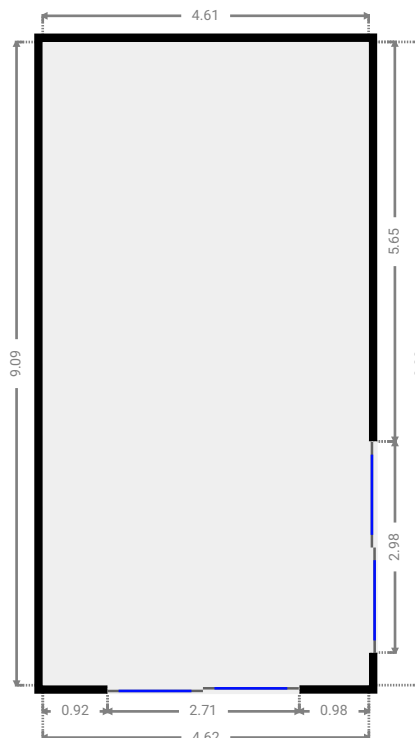

▼ WIR

Ground Floor

WIDTH:1.36 m · LENGTH:1.42 m
AREA:1.93 m² · PERIMETER:5.55 m

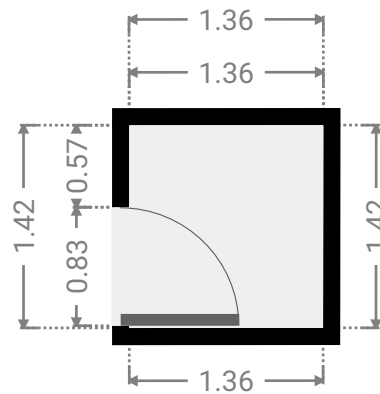

▼ Bedroom

Ground Floor

WIDTH:4.74 m · LENGTH:3.97 m
AREA:14.24 m² · PERIMETER:17.42 m

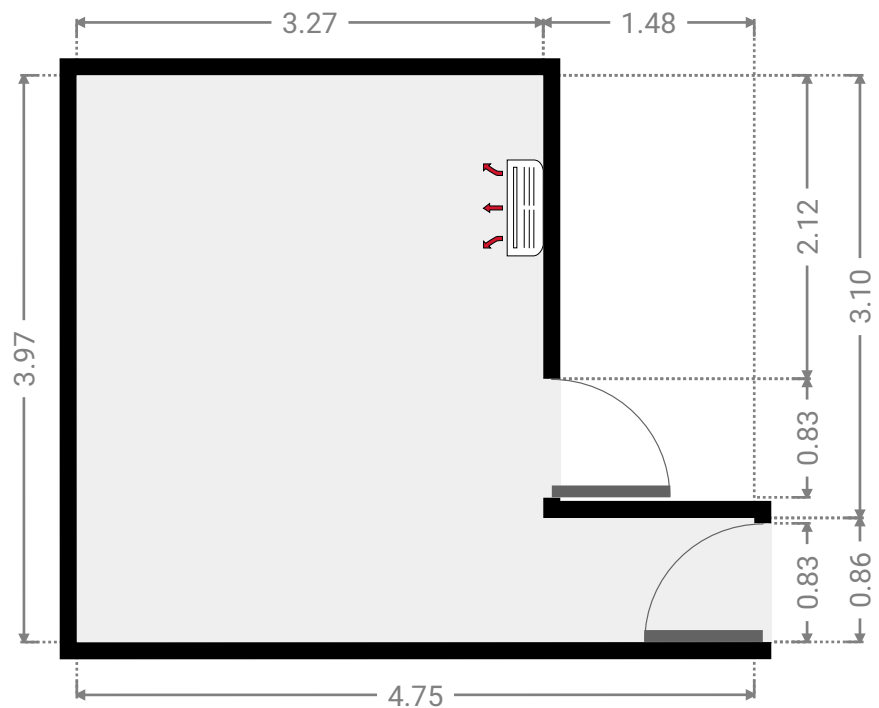

▼ WIR

Ground Floor

WIDTH:1.37 m · LENGTH:1.44 m
AREA:1.97 m² · PERIMETER:5.62 m

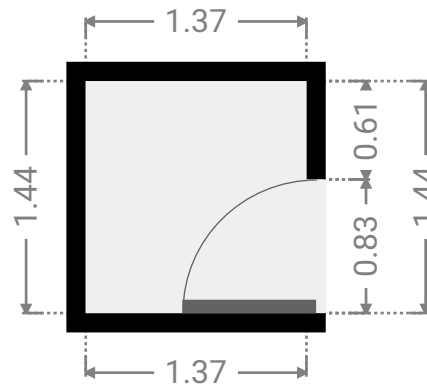

▼ Bedroom

Ground Floor

WIDTH:3.57 m · LENGTH:2.97 m
AREA:10.60 m² · PERIMETER:13.08 m

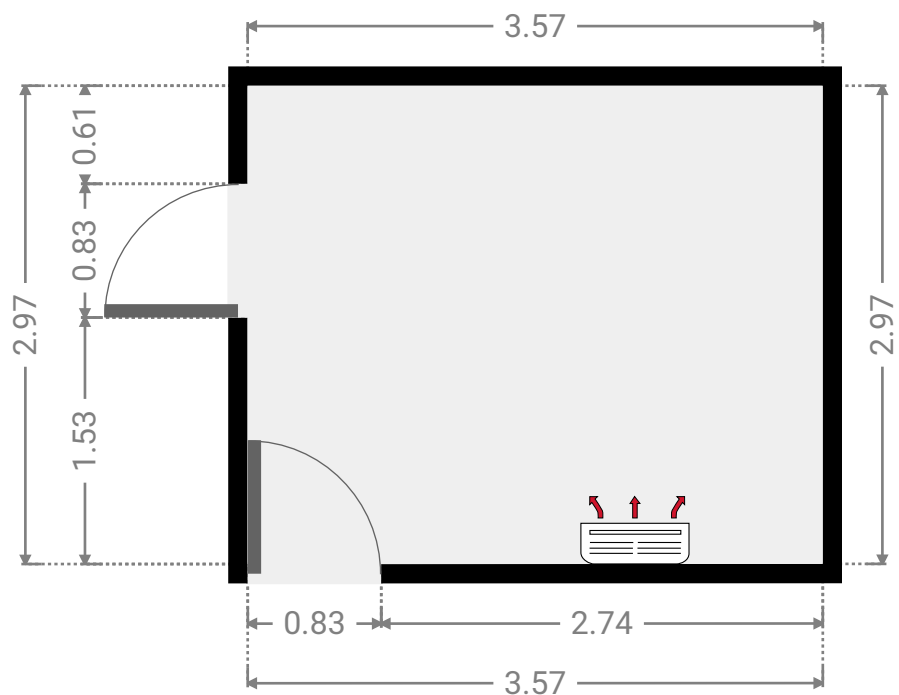

▼ Bathroom
Ground Floor

WIDTH:3.15 m · LENGTH:1.76 m
AREA:5.58 m² · PERIMETER:9.84 m

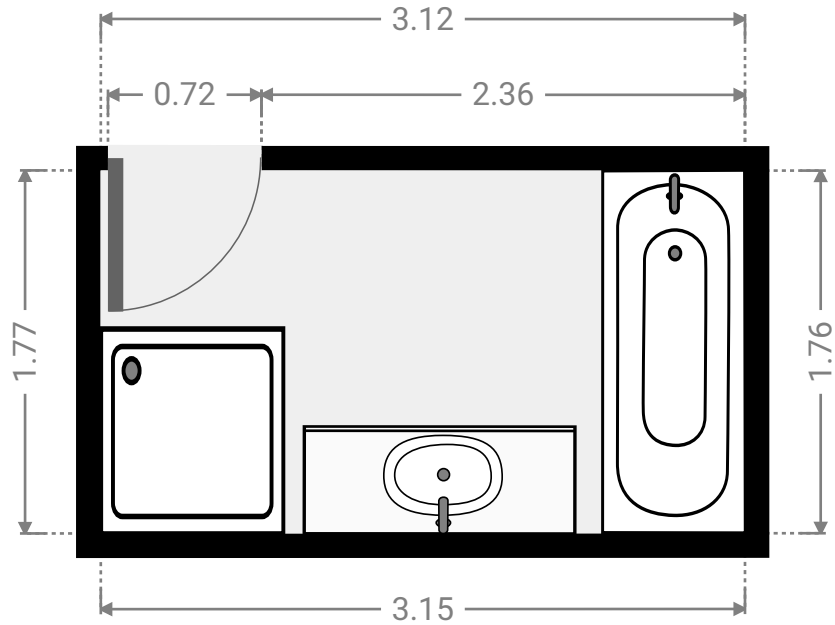

▼ Laundry Room
Ground Floor

WIDTH:2.67 m · LENGTH:1.97 m
AREA:5.25 m² · PERIMETER:9.27 m

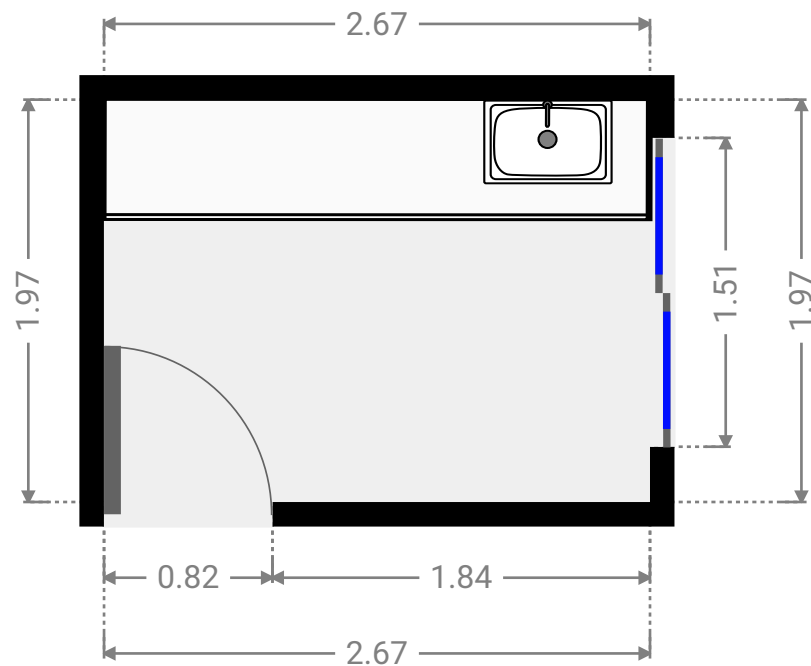

▼ Toilet

Ground Floor

WIDTH:1.47 m · LENGTH:0.88 m
AREA:1.29 m² · PERIMETER:4.70 m

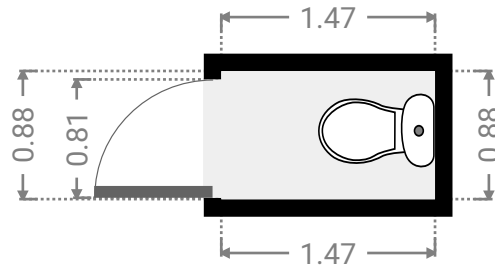

▼ Hall

Ground Floor

WIDTH:1.62 m · LENGTH:3.13 m
AREA:4.44 m² · PERIMETER:9.49 m

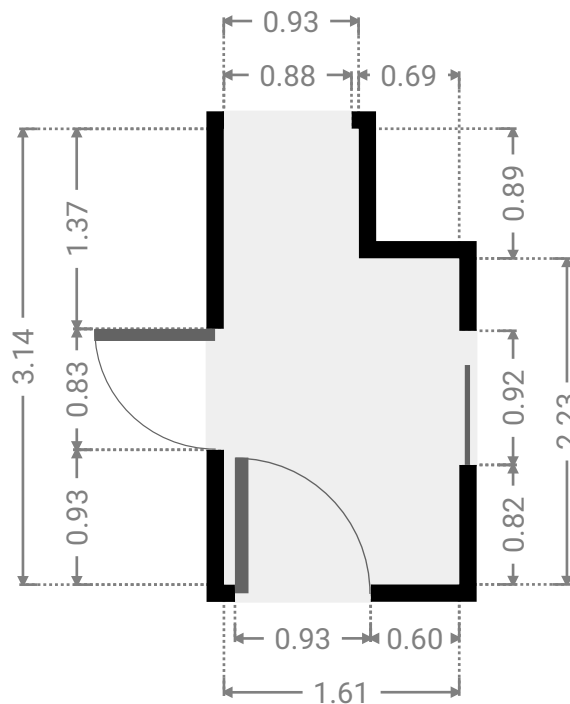

▼ Hall Ground Floor

WIDTH:2.62 m · LENGTH:4.83 m
AREA:6.97 m² · PERIMETER:14.91 m

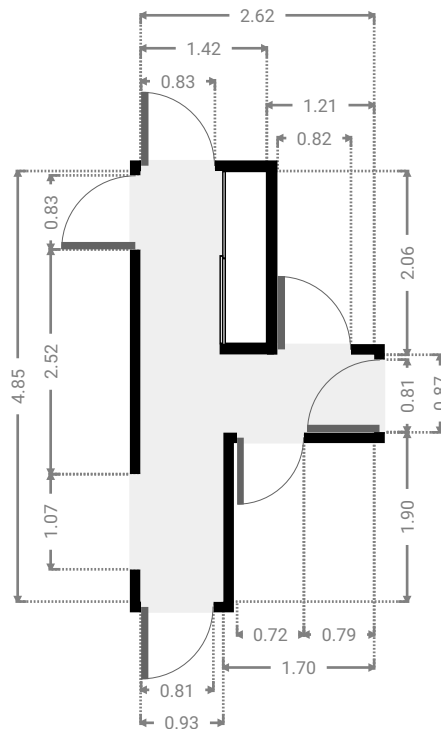

▼ WIR Ground Floor

WIDTH:1.85 m · LENGTH:2.36 m
AREA:4.35 m² · PERIMETER:8.40 m

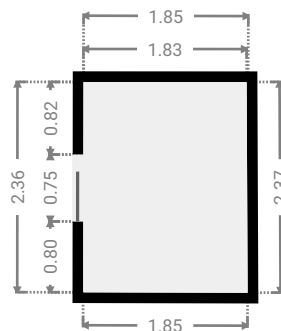
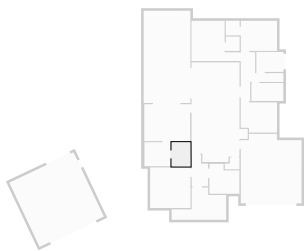

▼ **Ensuite**
Ground Floor

WIDTH:2.57 m · LENGTH:2.35 m
AREA:6.07 m² · PERIMETER:9.86 m

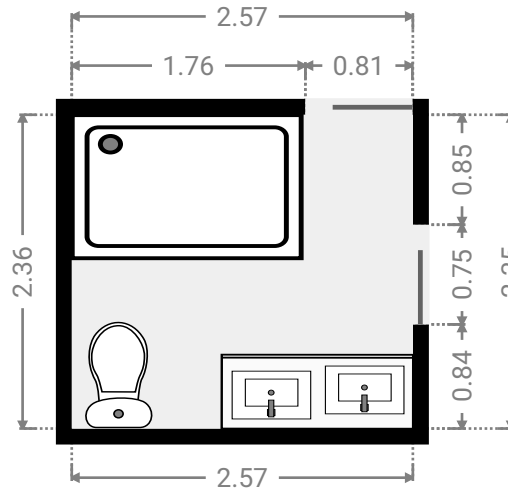

▼ **Master Bedroom**
Ground Floor

WIDTH:4.52 m · LENGTH:3.64 m
AREA:16.44 m² · PERIMETER:16.31 m

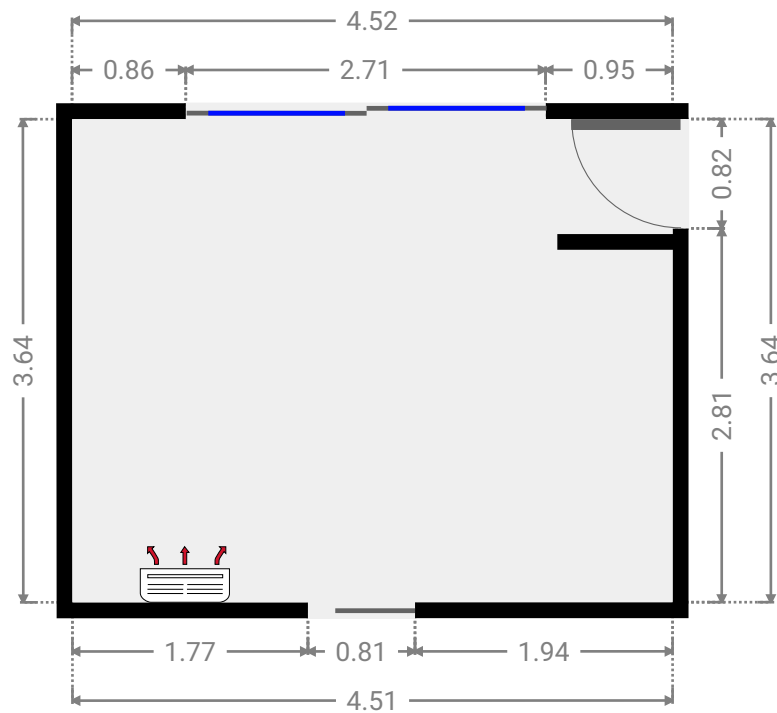
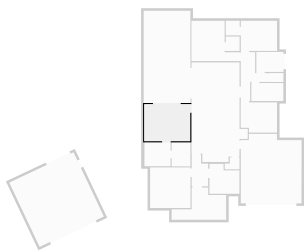

▼ Garage Ground Floor

WIDTH:5.98 m · LENGTH:6.85 m
AREA:39.01 m² · PERIMETER:25.67 m

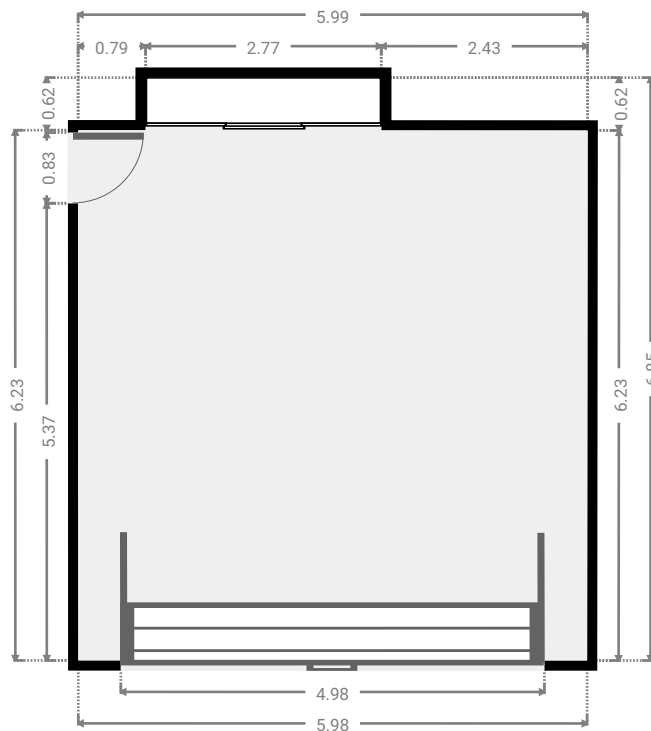
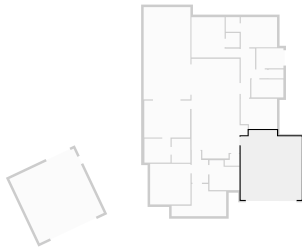

▼ Pantry Ground Floor

WIDTH:1.45 m · LENGTH:1.17 m
AREA:1.39 m² · PERIMETER:5.23 m

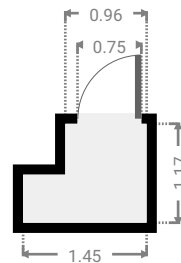

▼ Living Room Ground Floor

WIDTH:5.54 m · LENGTH:9.82 m
AREA:45.75 m² · PERIMETER:30.71 m

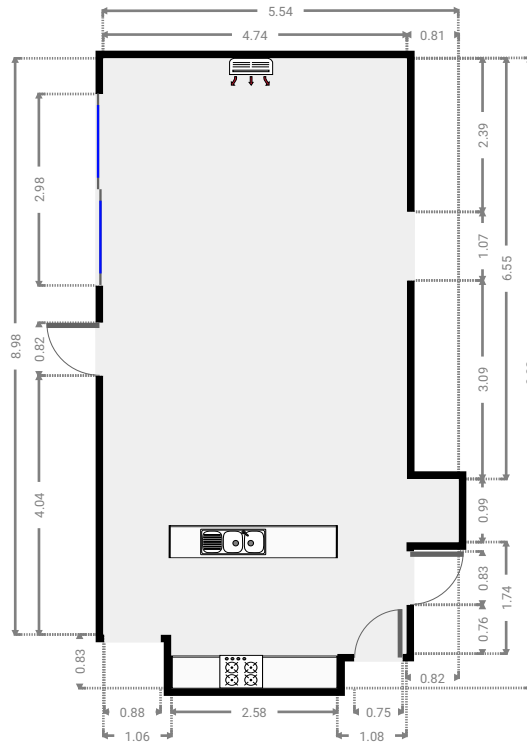

▼ Media Room Ground Floor

WIDTH:3.98 m · LENGTH:4.00 m
AREA:15.91 m² · PERIMETER:15.96 m

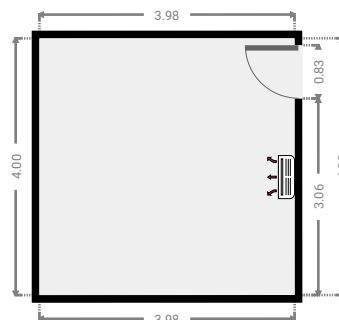
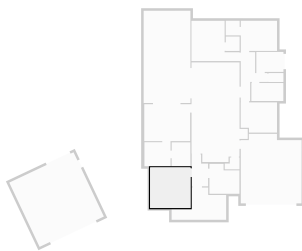

▼ **Study**
Ground Floor

WIDTH:2.95 m · LENGTH:2.94 m
AREA:7.69 m² · PERIMETER:11.79 m

