

7 Bean STREET

SUBMITTED BY

Ray White Rockhampton Casey
stockers@cqoz.com

CREATED ON

2022-11-02

Floors

2

▼ **Garage**
Ground Floor

WIDTH: 10.84 m • LENGTH: 11.18 m
AREA: 106.73 m² • PERIMETER: 44.05 m

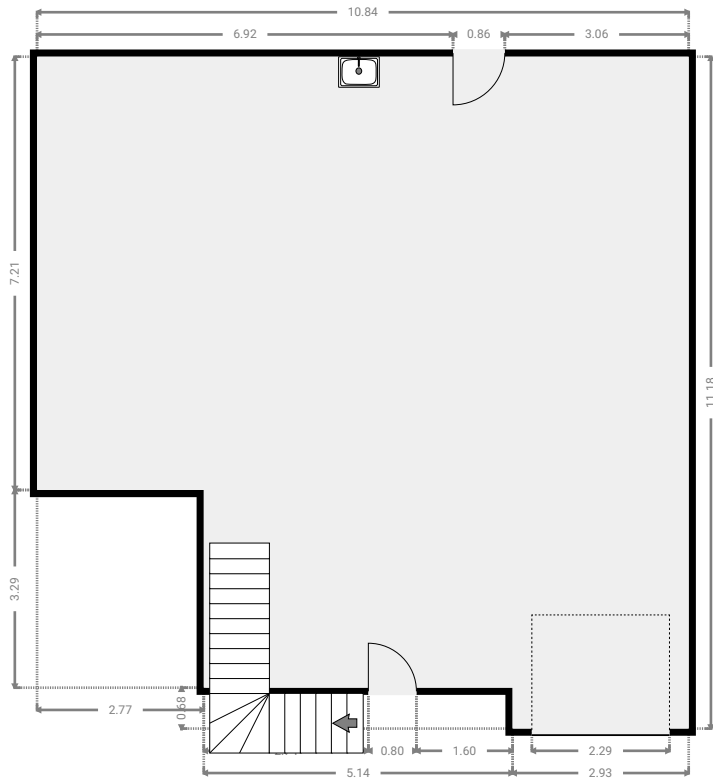
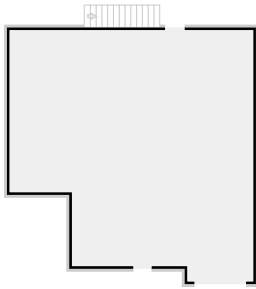

▼ 1st Floor



▼ **Bathroom**
1st Floor

WIDTH: 2.42 m • LENGTH: 1.76 m
AREA: 4.26 m² • PERIMETER: 8.36 m

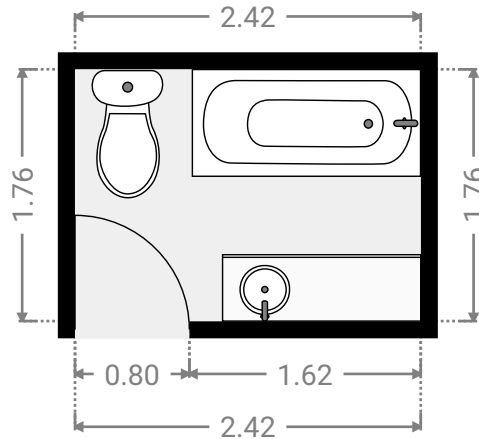
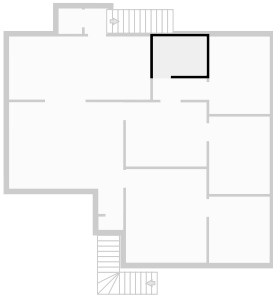

▼ **Bedroom**
1st Floor

WIDTH: 3.63 m • LENGTH: 4.22 m
AREA: 15.32 m² • PERIMETER: 15.70 m

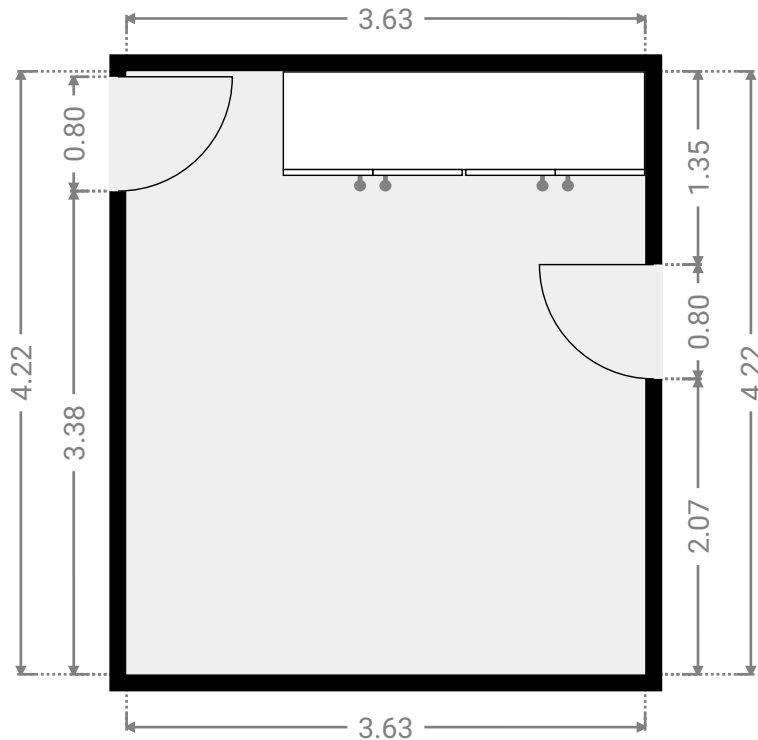
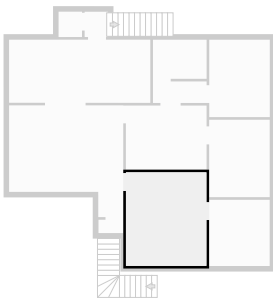

▼ **Bedroom**
1st Floor

WIDTH: 2.73 m • LENGTH: 3.49 m
AREA: 9.53 m² • PERIMETER: 12.44 m

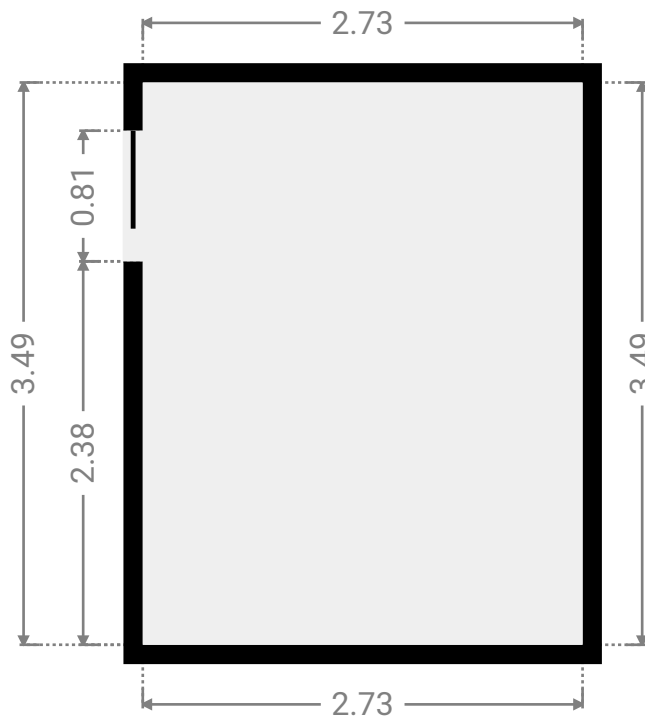
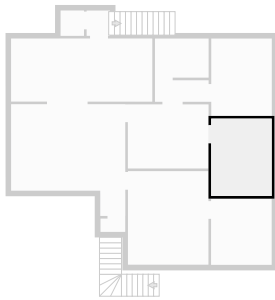

▼ **Bedroom**
1st Floor

WIDTH: 2.73 m • LENGTH: 3.49 m
AREA: 9.53 m² • PERIMETER: 12.44 m

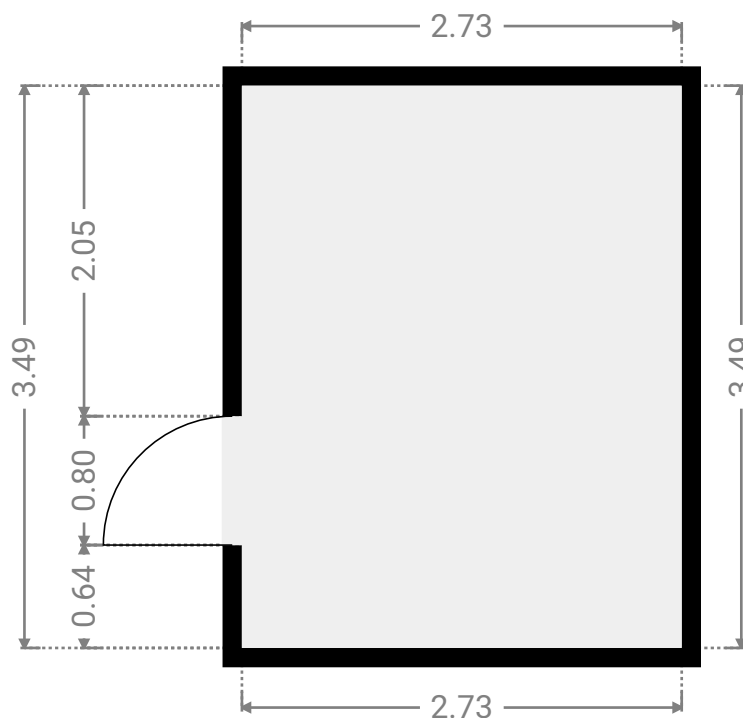
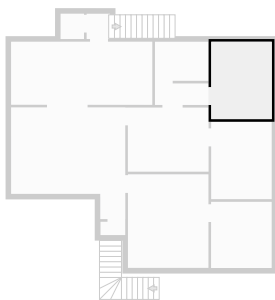

▼ **Hall**
1st Floor

WIDTH: 1.13 m • LENGTH: 1.02 m
AREA: 1.15 m² • PERIMETER: 4.30 m

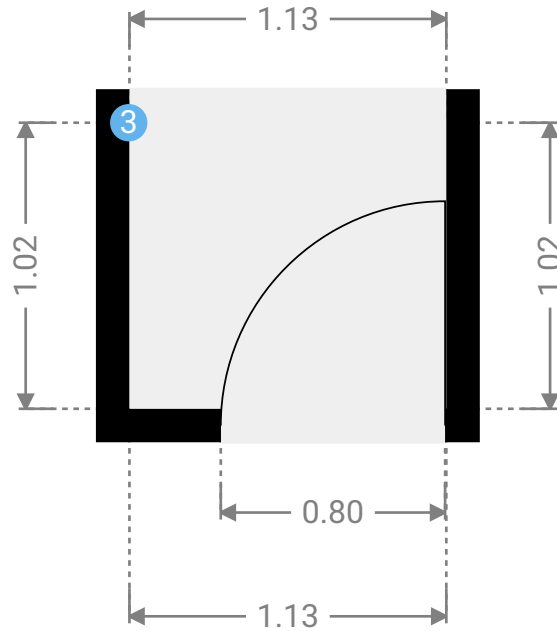

▼ **Hall/1st Floor**

3 OPENING

Height
0.00 m



▼ **Hall**
1st Floor

WIDTH: 2.42 m • LENGTH: 0.97 m
AREA: 2.35 m² • PERIMETER: 6.78 m

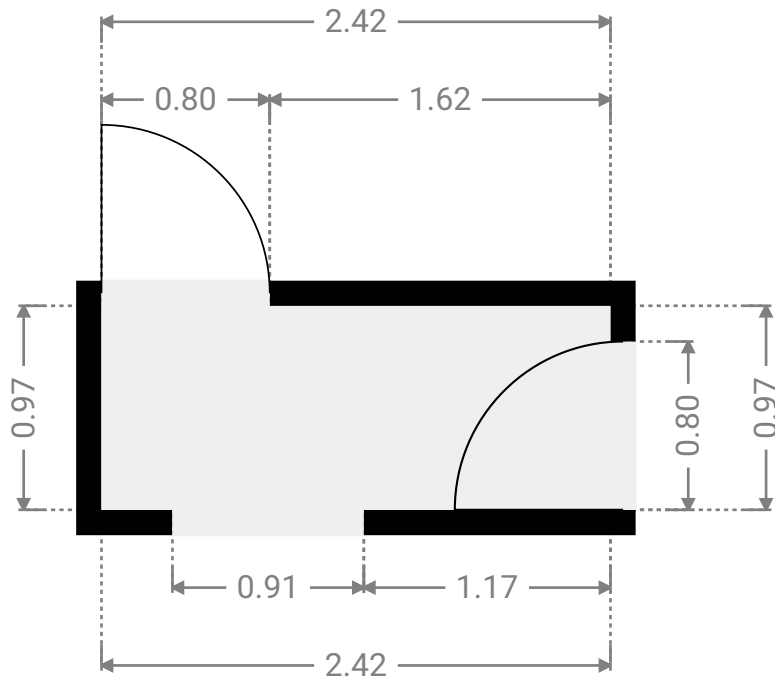

▼ **Hall**
1st Floor

WIDTH: 1.05 m • LENGTH: 1.14 m
AREA: 1.20 m² • PERIMETER: 4.38 m

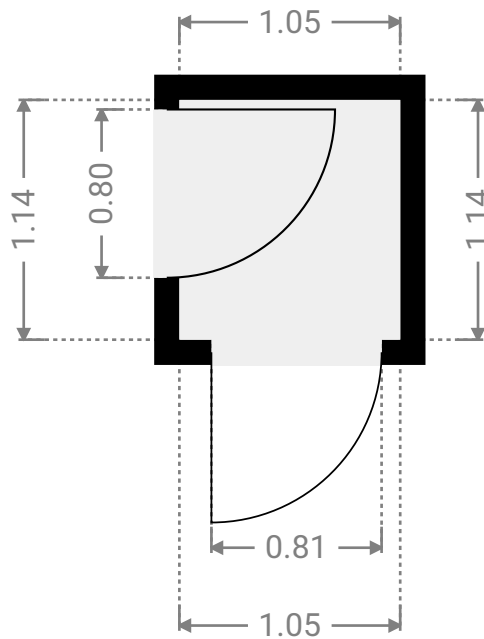
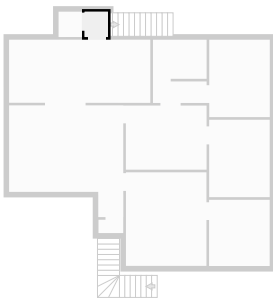

▼ Kitchen 1st Floor

WIDTH: 6.37 m • LENGTH: 2.85 m
AREA: 18.13 m² • PERIMETER: 18.43 m

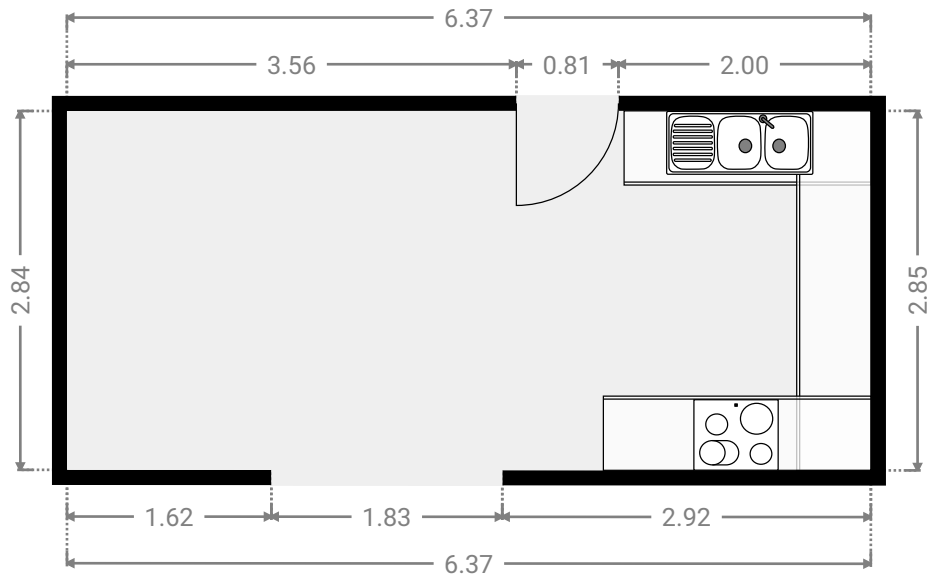
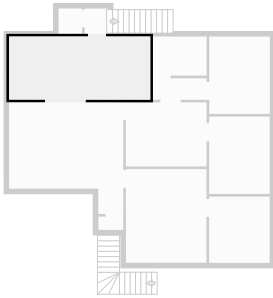

▼ Living Room 1st Floor

WIDTH: 5.15 m • LENGTH: 3.90 m
AREA: 20.08 m² • PERIMETER: 18.10 m

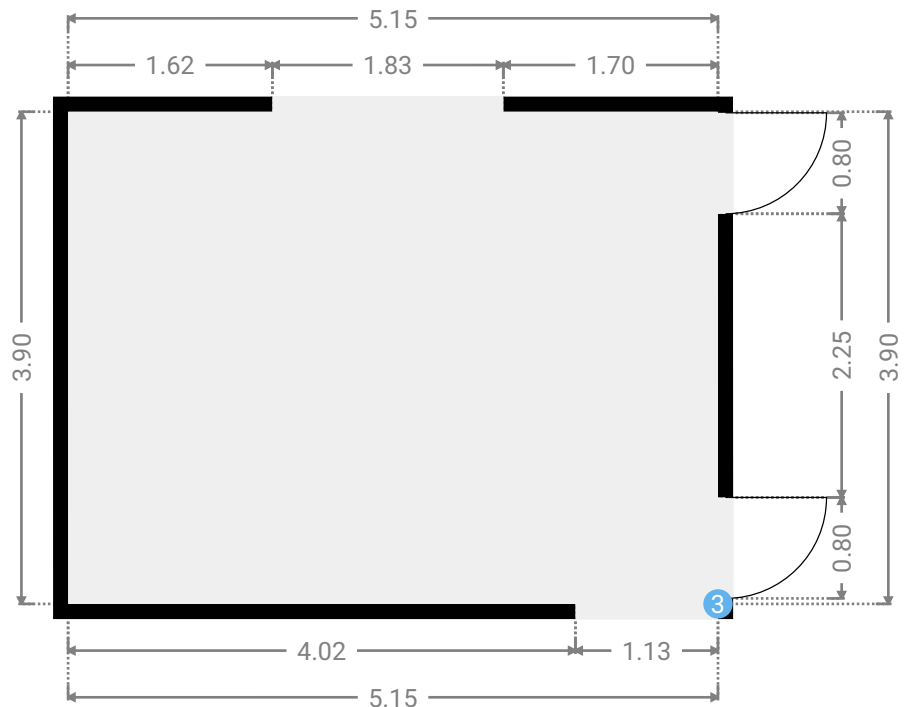
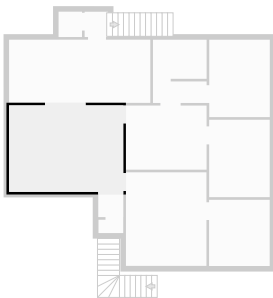

▼ **Living Room**
1st Floor

WIDTH: 3.64 m • LENGTH: 2.89 m
AREA: 10.52 m² • PERIMETER: 13.06 m

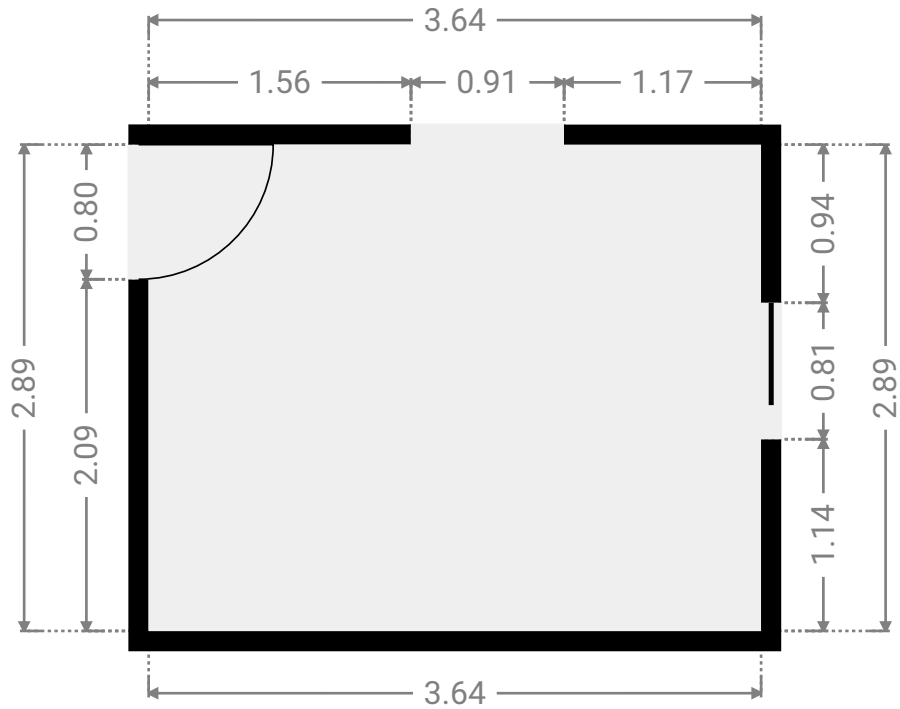
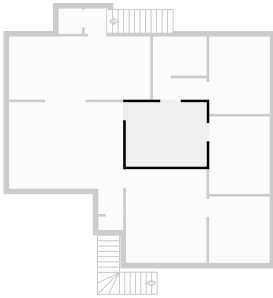

▼ **Other**
1st Floor

WIDTH: 2.73 m • LENGTH: 2.99 m
AREA: 8.16 m² • PERIMETER: 11.44 m

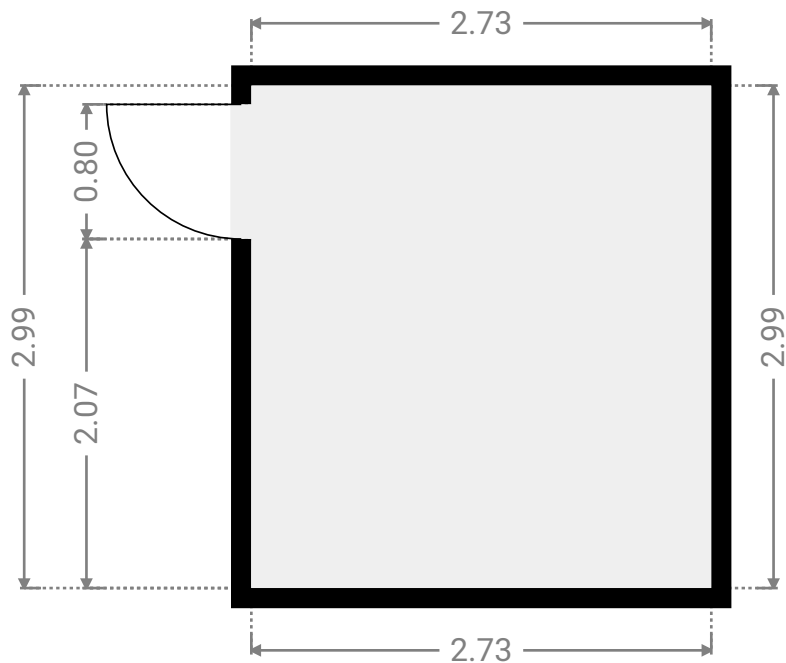
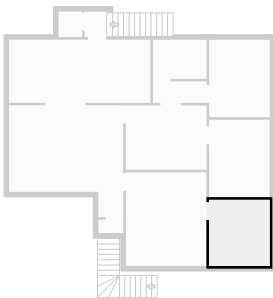

▼ Other
1st Floor

WIDTH: 1.12 m • LENGTH: 0.60 m
AREA: 0.67 m² • PERIMETER: 3.43 m

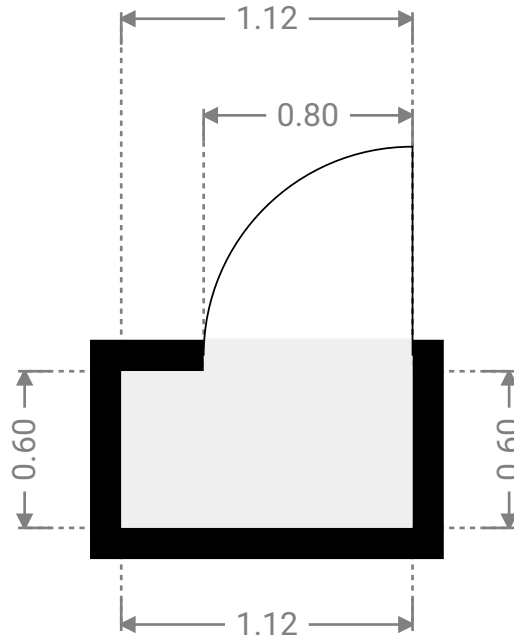
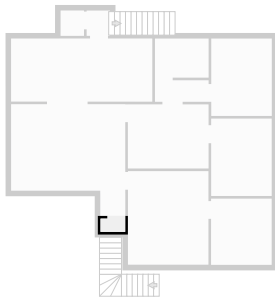

▼ Toilet
1st Floor

WIDTH: 1.06 m • LENGTH: 1.14 m
AREA: 1.21 m² • PERIMETER: 4.40 m

