

# 68 Rice Street

Created on  
2021-03-25

Floors  
1

▼ Ground Floor

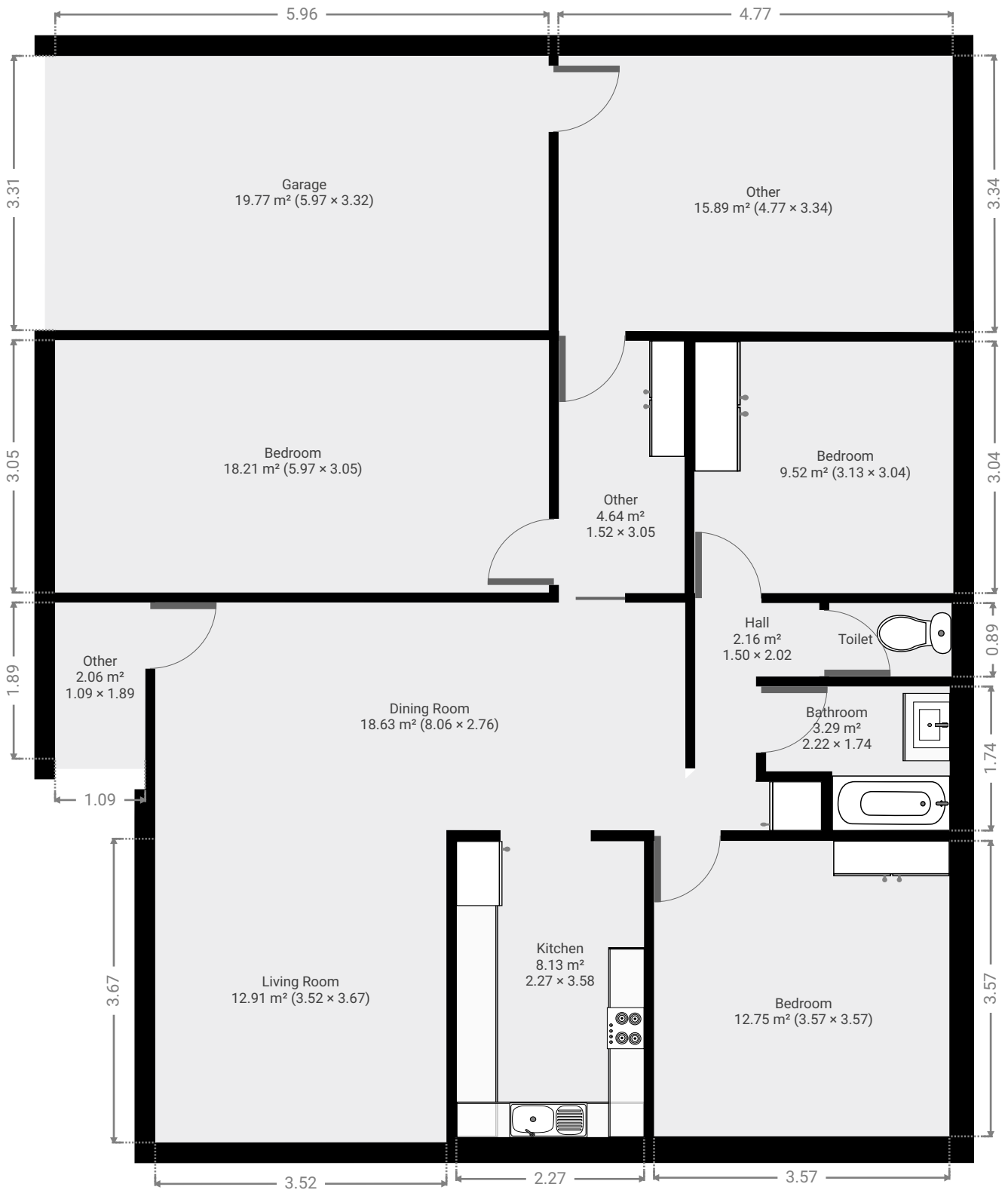

▼ Dining Room  
Ground Floor

WIDTH: 2.76 m • LENGTH: 8.06 m  
AREA: 18.63 m<sup>2</sup> • PERIMETER: 21.61 m

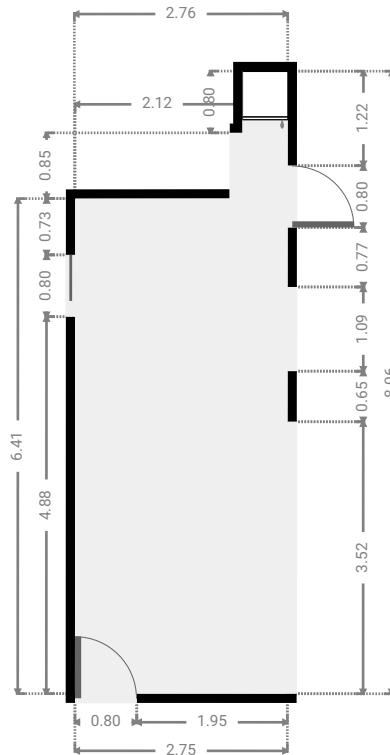
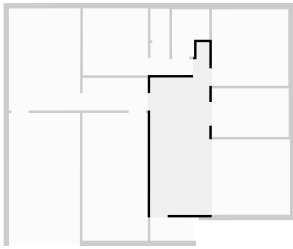

▼ Living Room  
Ground Floor

WIDTH: 3.67 m • LENGTH: 3.52 m  
AREA: 12.91 m<sup>2</sup> • PERIMETER: 14.38 m

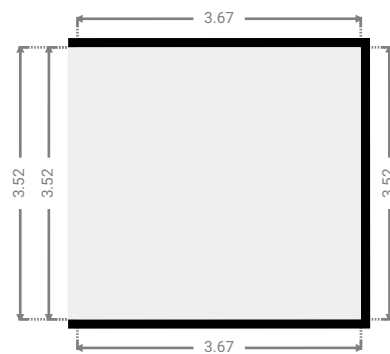
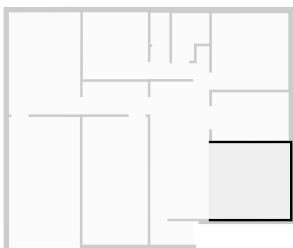

▼ **Kitchen**  
Ground Floor

WIDTH: 3.58 m • LENGTH: 2.27 m  
AREA: 8.13 m<sup>2</sup> • PERIMETER: 11.70 m

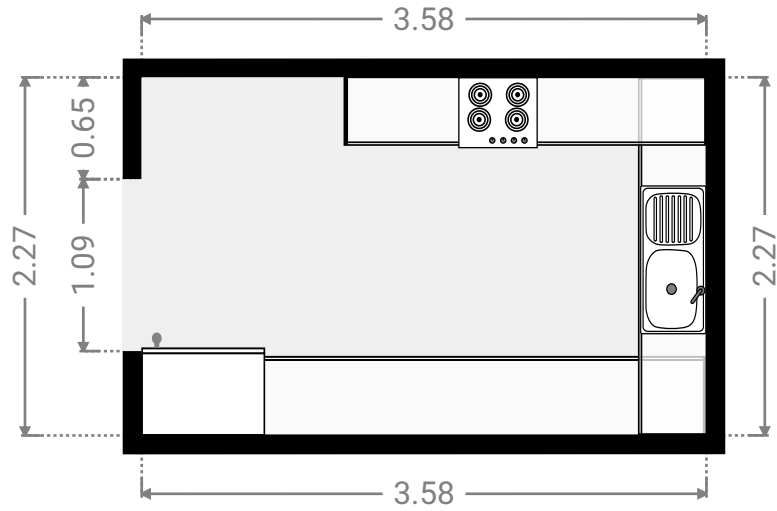
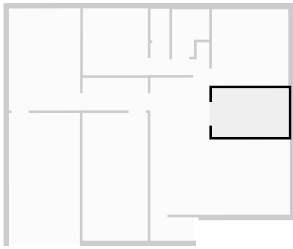

▼ **Bedroom**  
Ground Floor

WIDTH: 3.57 m • LENGTH: 3.57 m  
AREA: 12.75 m<sup>2</sup> • PERIMETER: 14.28 m

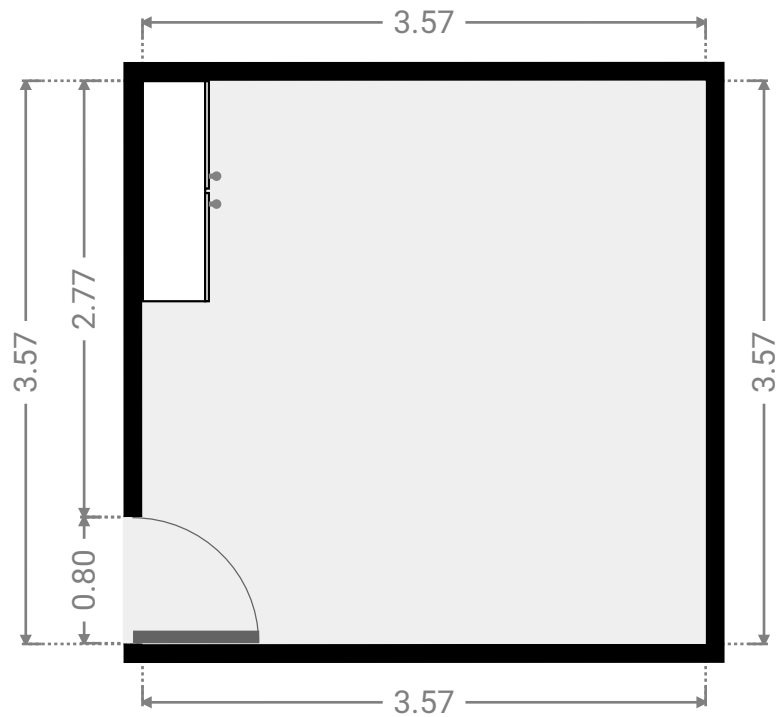
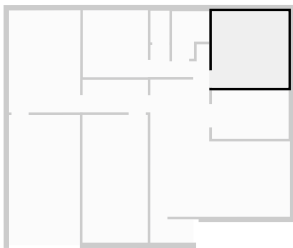

▼ **Hall**  
Ground Floor

WIDTH: 2.02 m • LENGTH: 1.50 m  
AREA: 2.16 m<sup>2</sup> • PERIMETER: 7.04 m

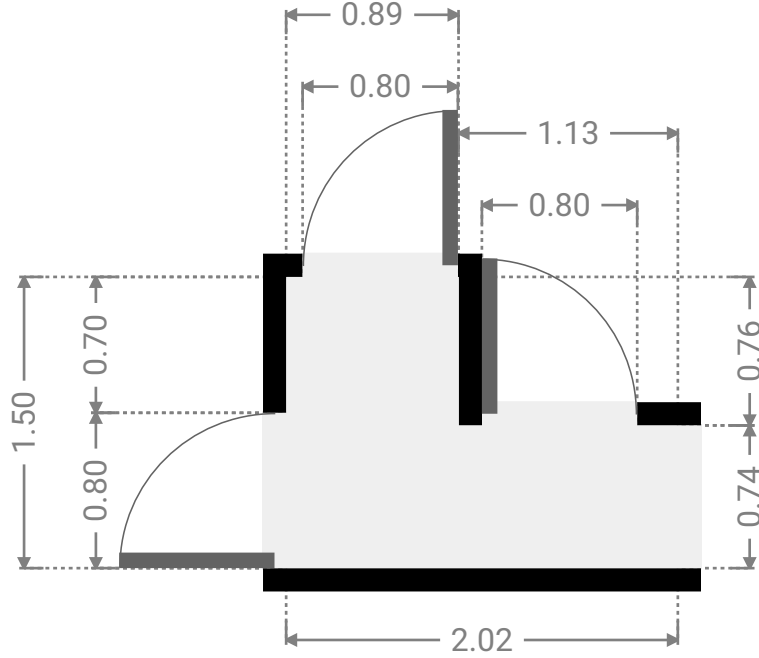
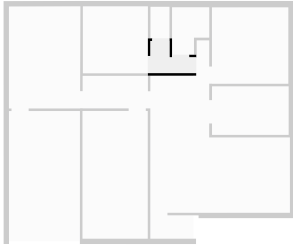

▼ **Bathroom**  
Ground Floor

WIDTH: 1.74 m • LENGTH: 2.22 m  
AREA: 3.29 m<sup>2</sup> • PERIMETER: 7.92 m

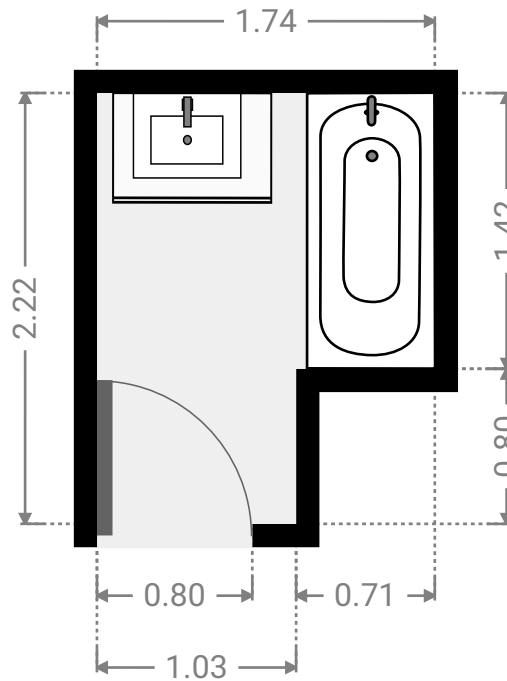
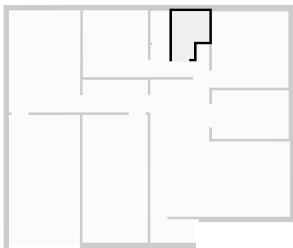

▼ **Toilet**  
Ground Floor

WIDTH: 0.89 m • LENGTH: 1.48 m  
AREA: 1.31 m<sup>2</sup> • PERIMETER: 4.73 m

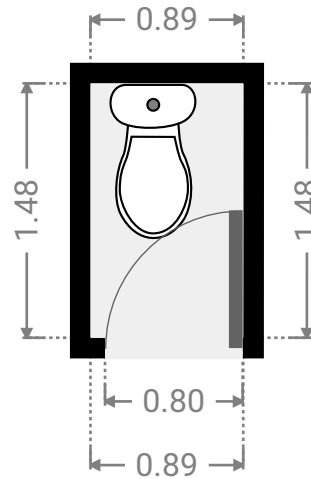
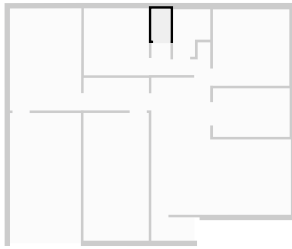

▼ **Bedroom**  
Ground Floor

WIDTH: 3.04 m • LENGTH: 3.13 m  
AREA: 9.52 m<sup>2</sup> • PERIMETER: 12.34 m

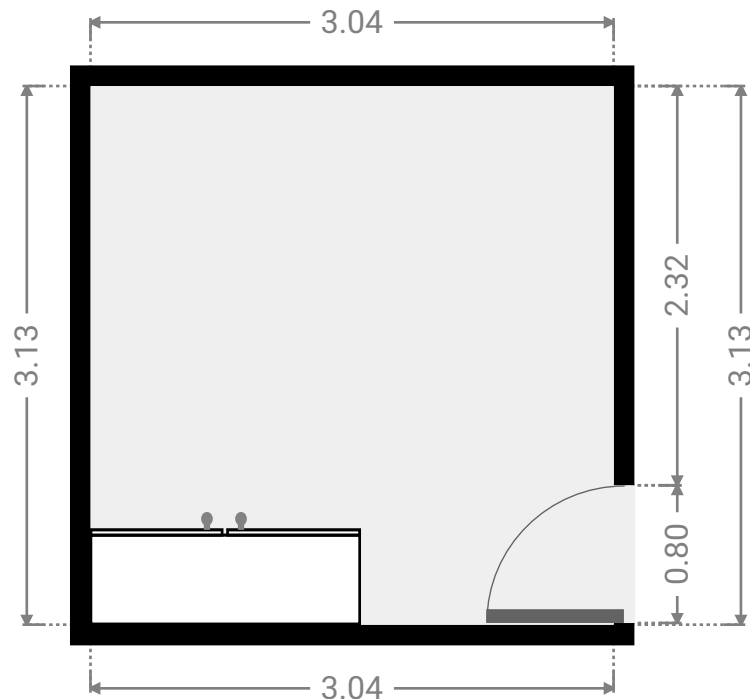
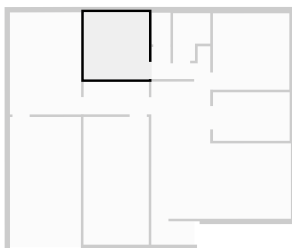

▼ Other  
Ground Floor

WIDTH: 3.05 m • LENGTH: 1.52 m  
AREA: 4.64 m<sup>2</sup> • PERIMETER: 9.14 m

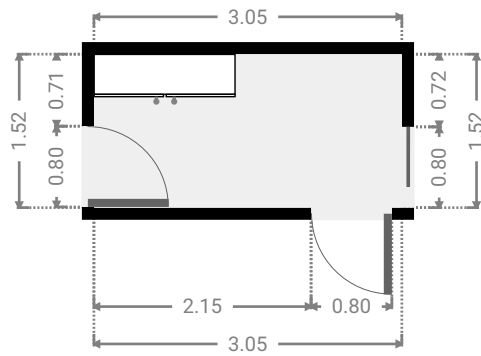
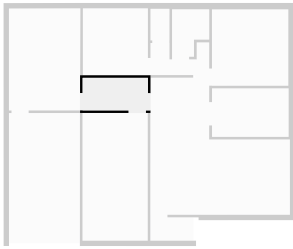

▼ Bedroom  
Ground Floor

WIDTH: 3.05 m • LENGTH: 5.97 m  
AREA: 18.21 m<sup>2</sup> • PERIMETER: 18.04 m

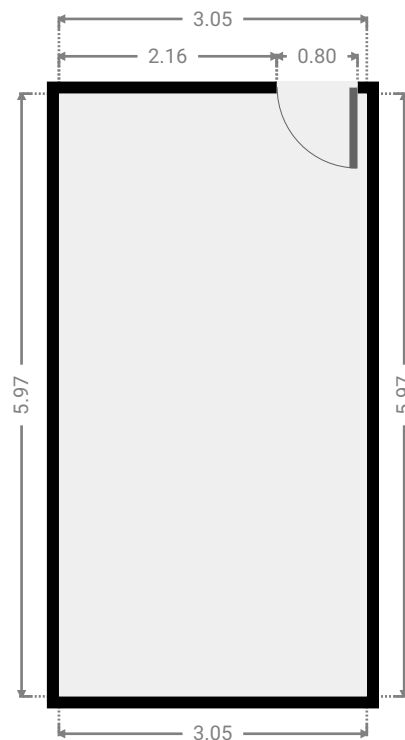
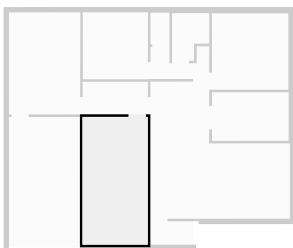

▼ Other  
Ground Floor

WIDTH: 1.89 m • LENGTH: 1.09 m  
AREA: 2.06 m<sup>2</sup> • PERIMETER: 5.96 m

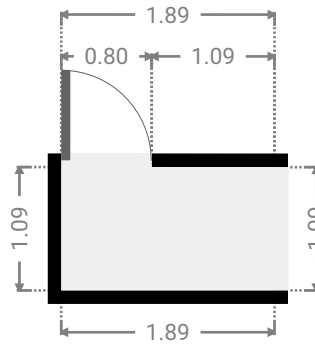
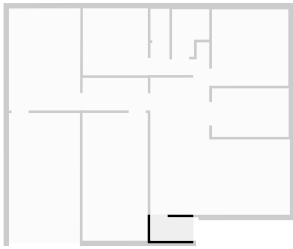

▼ Other  
Ground Floor

WIDTH: 3.34 m • LENGTH: 4.77 m  
AREA: 15.89 m<sup>2</sup> • PERIMETER: 16.20 m

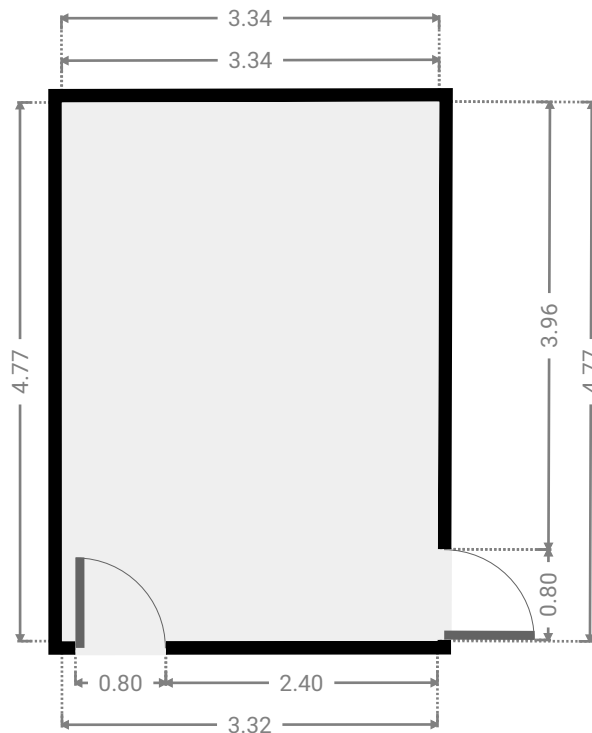
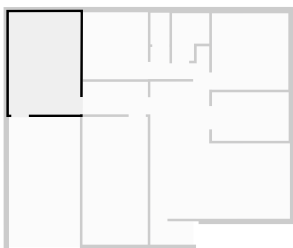



▼ **Garage**  
Ground Floor

WIDTH: 3.32 m • LENGTH: 5.97 m  
AREA: 19.77 m<sup>2</sup> • PERIMETER: 18.56 m

