

67 Livingstone Street

Ground Floor

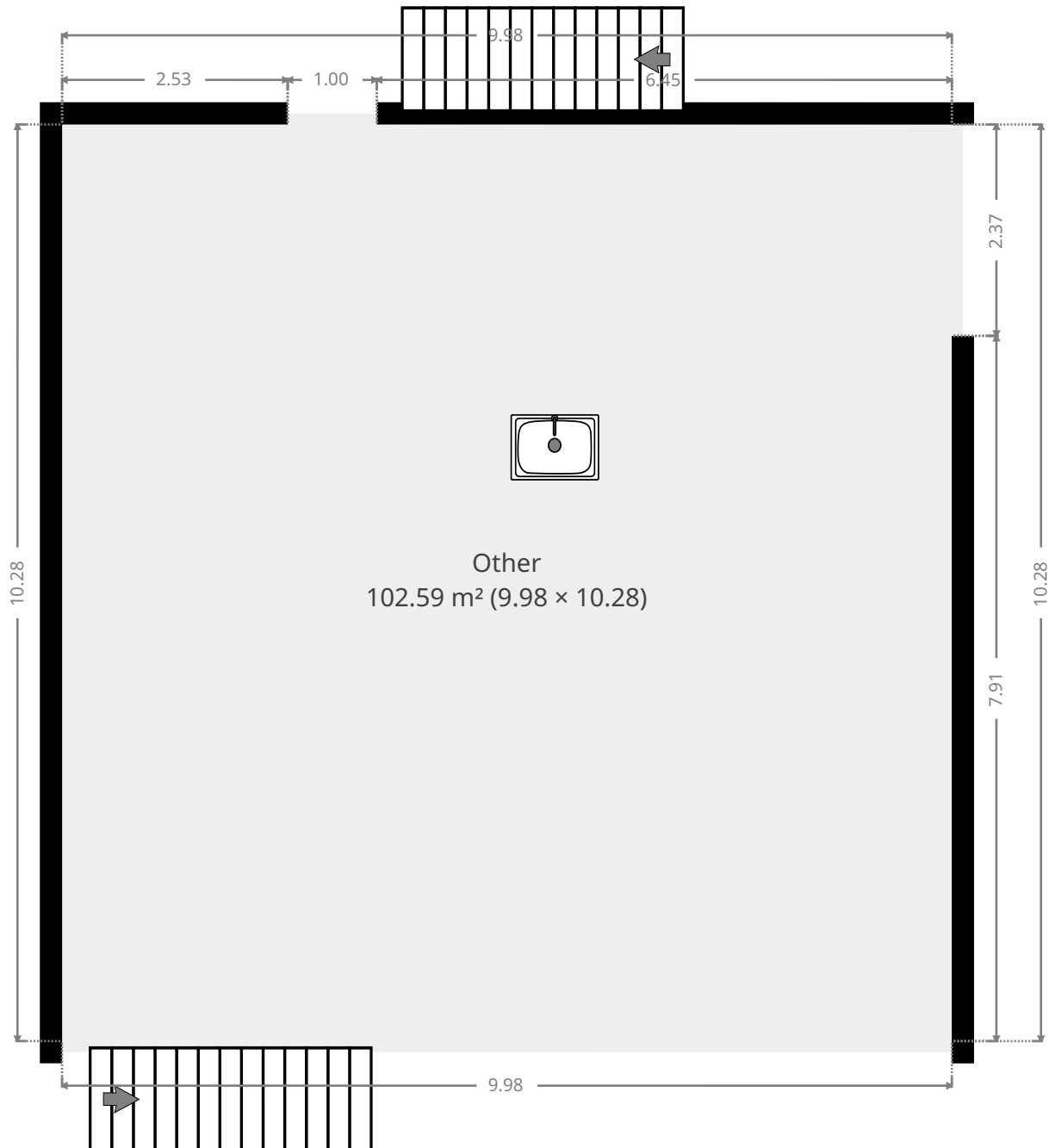

THIS FLOORPLAN IS PROVIDED WITHOUT WARRANTY OF ANY KIND. SENSOPIA DISCLAIMS ANY WARRANTY INCLUDING, WITHOUT LIMITATION, SATISFACTORY QUALITY OR ACCURACY OF DIMENSIONS.



67 Livingstone Street

Other

Width: 9.98 m
Length: 10.28 m
Area: 102.59 m²
Perimeter: 40.52 m

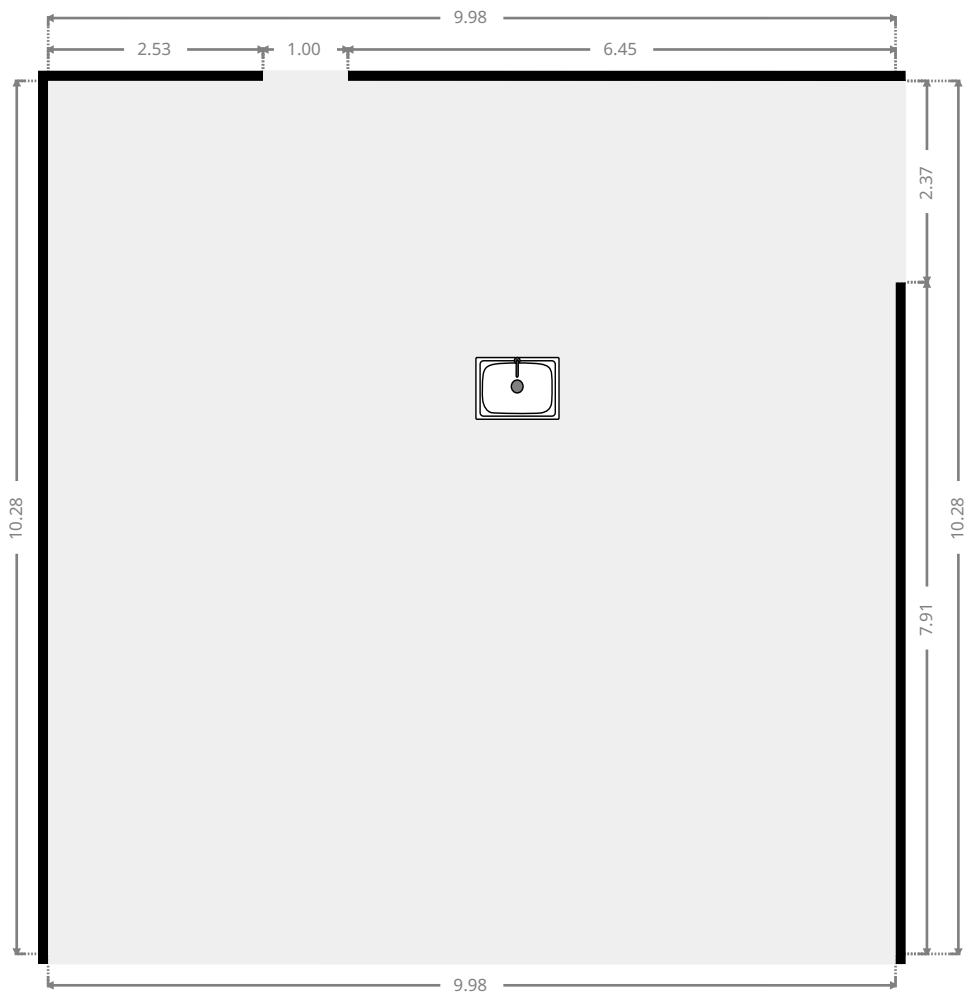
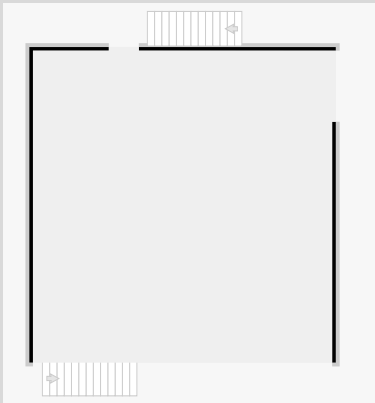

THIS FLOORPLAN IS PROVIDED WITHOUT WARRANTY OF ANY KIND. SENSOPIA DISCLAIMS ANY WARRANTY INCLUDING, WITHOUT LIMITATION, SATISFACTORY QUALITY OR ACCURACY OF DIMENSIONS.



67 Livingstone Street

1st Floor

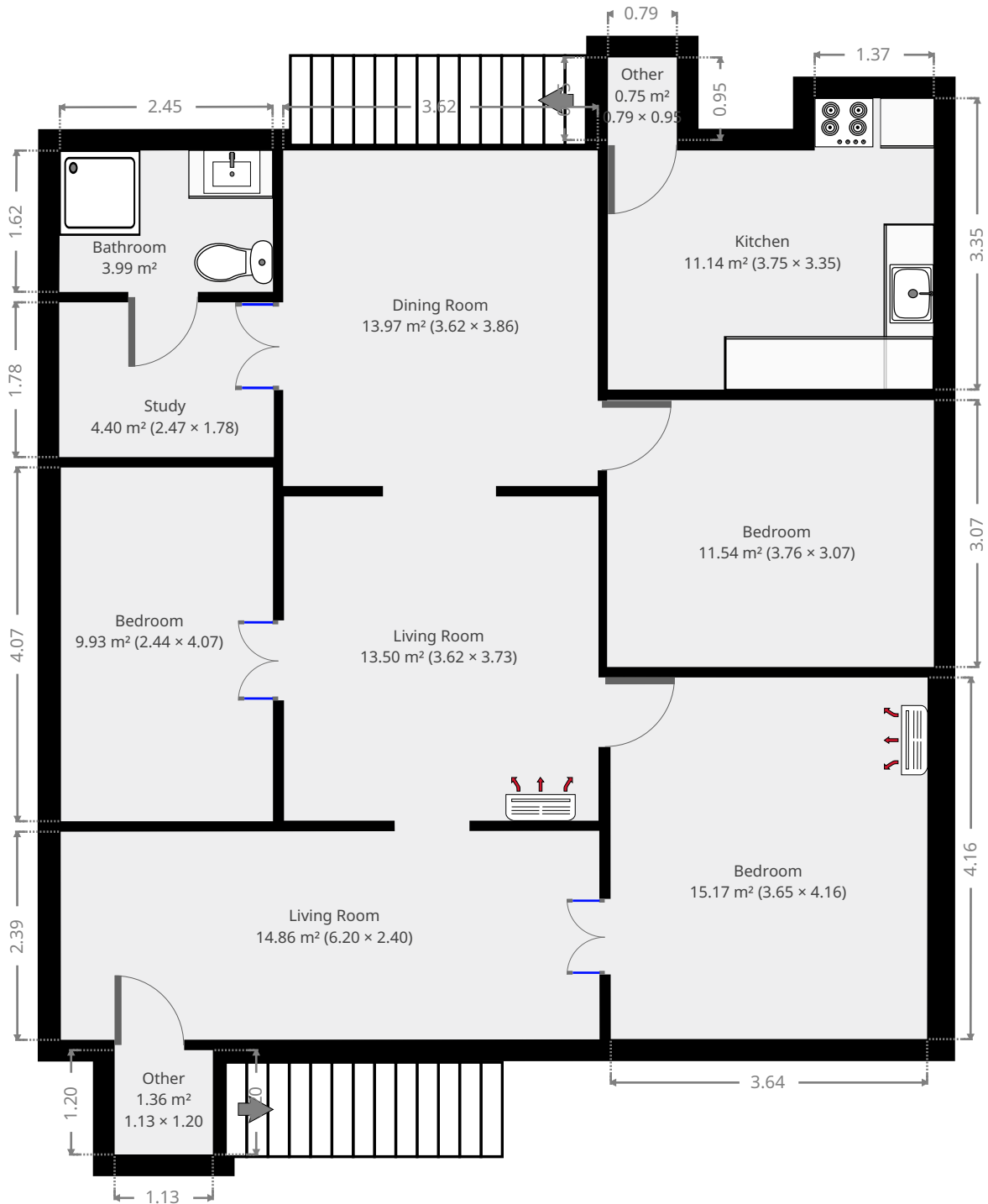

THIS FLOORPLAN IS PROVIDED WITHOUT WARRANTY OF ANY KIND. SENSOPIA DISCLAIMS ANY WARRANTY INCLUDING, WITHOUT LIMITATION, SATISFACTORY QUALITY OR ACCURACY OF DIMENSIONS.



67 Livingstone Street

Living Room

Width: 2.40 m
 Length: 6.20 m
 Area: 14.86 m²
 Perimeter: 17.19 m

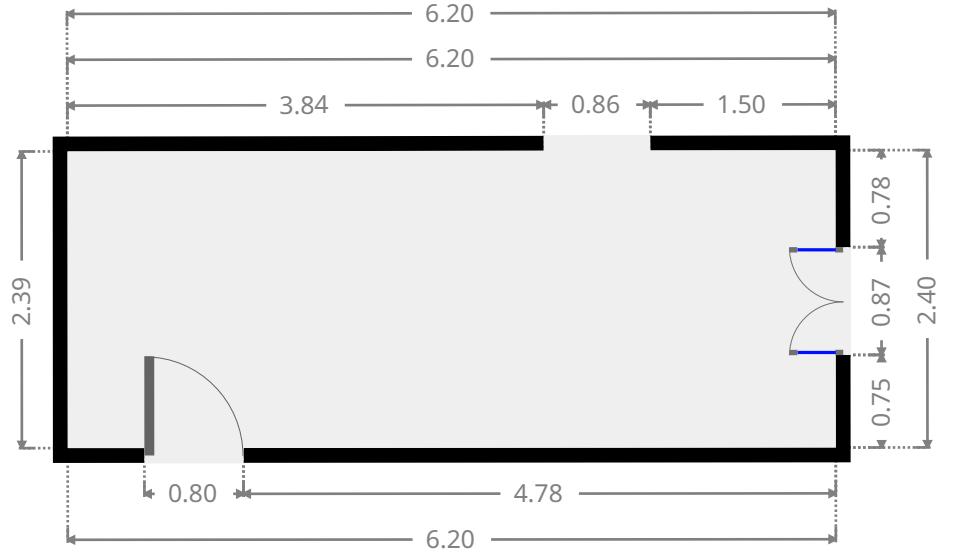
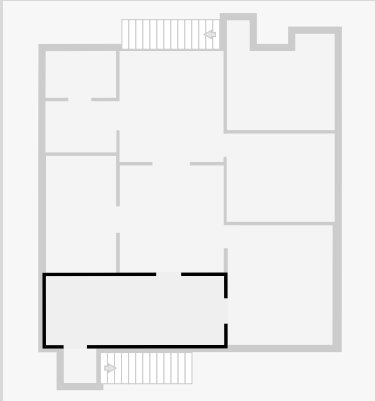

Living Room

Width: 3.62 m
 Length: 3.73 m
 Area: 13.50 m²
 Perimeter: 14.70 m

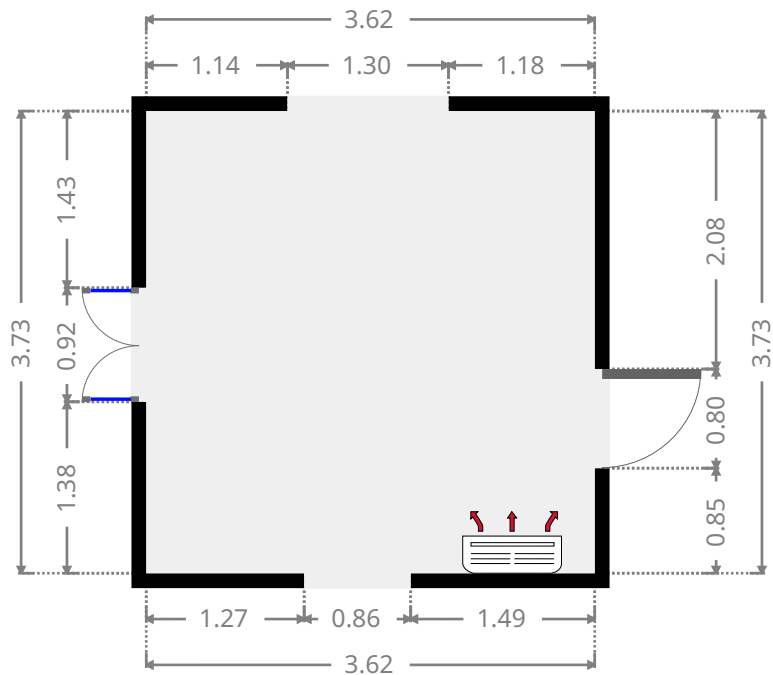
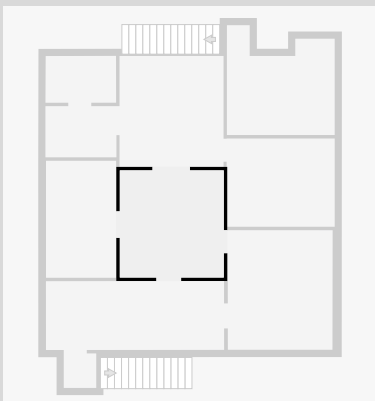

THIS FLOORPLAN IS PROVIDED WITHOUT WARRANTY OF ANY KIND. SENSOPIA DISCLAIMS ANY WARRANTY INCLUDING, WITHOUT LIMITATION, SATISFACTORY QUALITY OR ACCURACY OF DIMENSIONS.

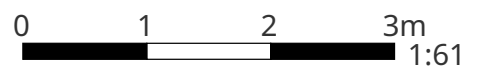

67 Livingstone Street

Bedroom

Width: 3.65 m
 Length: 4.16 m
 Area: 15.17 m²
 Perimeter: 15.61 m

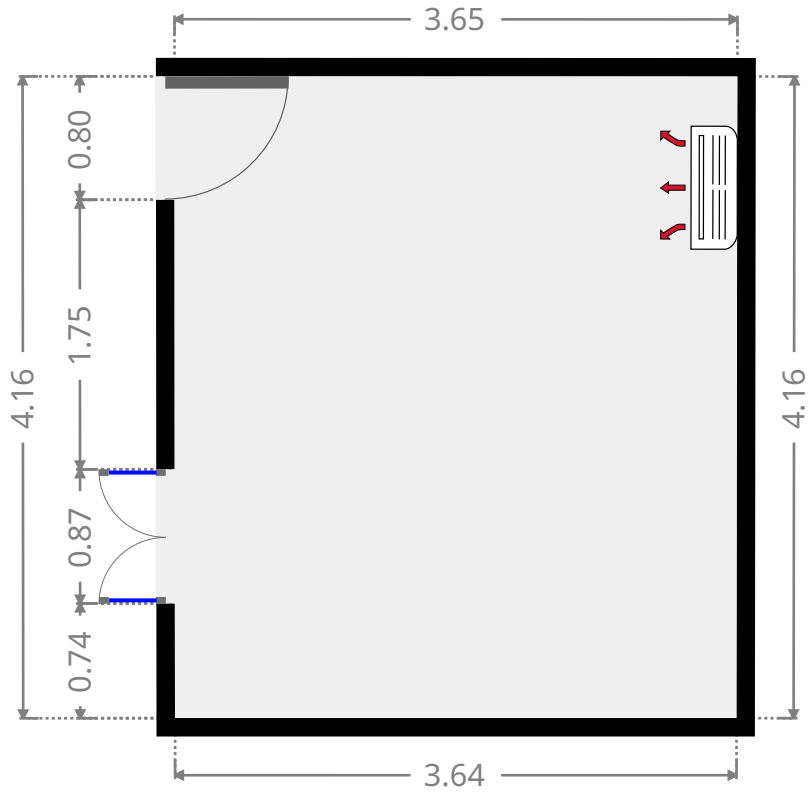
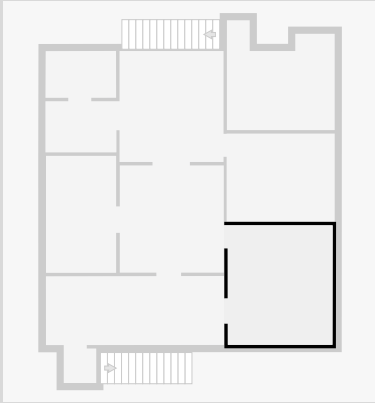

Bedroom

Width: 2.44 m
 Length: 4.07 m
 Area: 9.93 m²
 Perimeter: 13.02 m

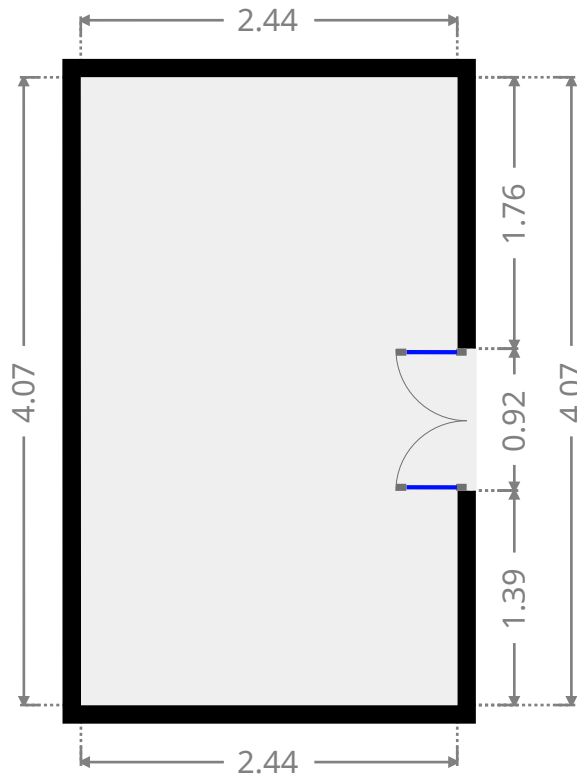
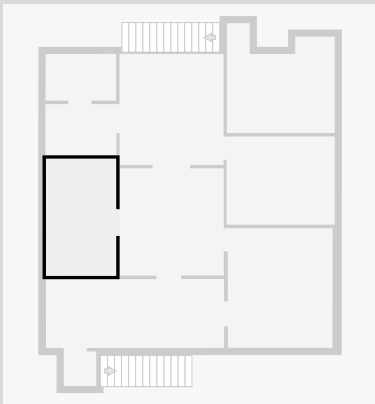

THIS FLOORPLAN IS PROVIDED WITHOUT WARRANTY OF ANY KIND. SENSOPIA DISCLAIMS ANY WARRANTY INCLUDING, WITHOUT LIMITATION, SATISFACTORY QUALITY OR ACCURACY OF DIMENSIONS.

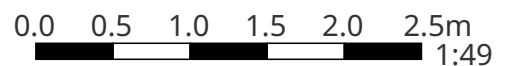

67 Livingstone Street

Dining Room

Width: 3.62 m
 Length: 3.86 m
 Area: 13.97 m²
 Perimeter: 14.96 m

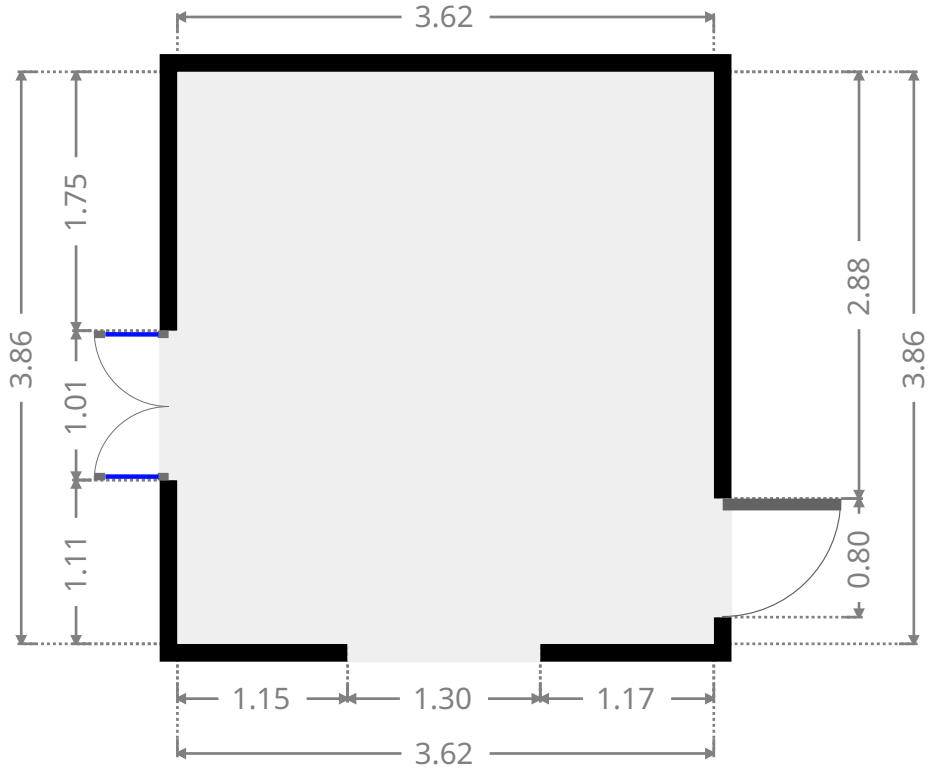
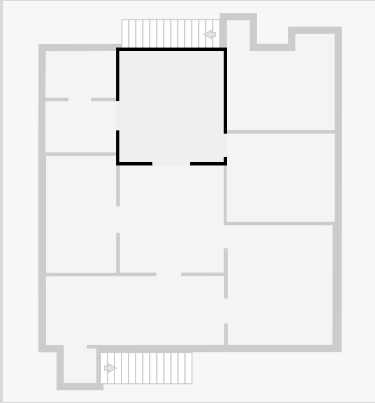

Bedroom

Width: 3.07 m
 Length: 3.76 m
 Area: 11.54 m²
 Perimeter: 13.66 m

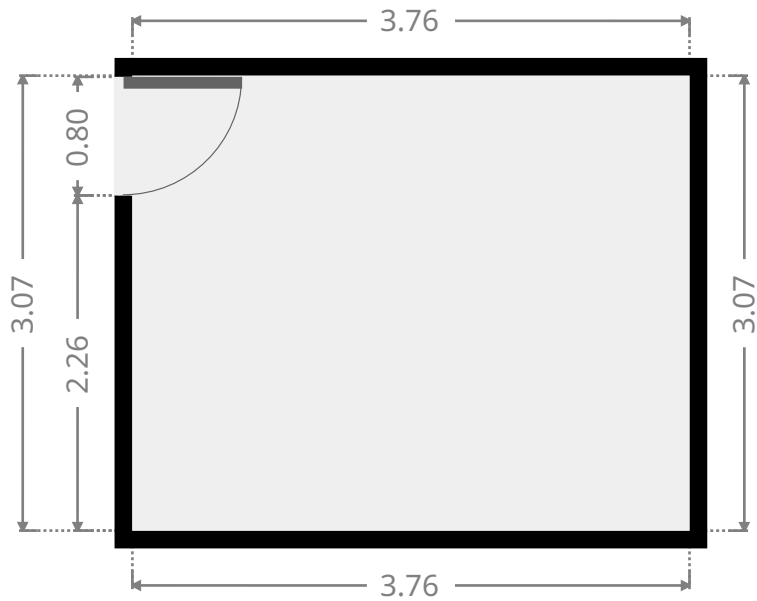
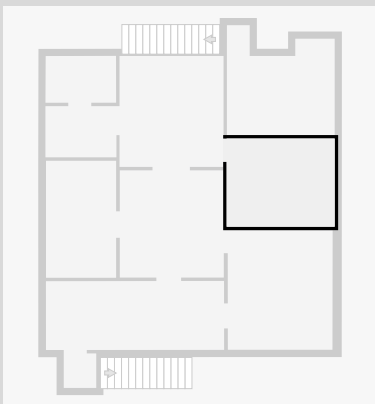

THIS FLOORPLAN IS PROVIDED WITHOUT WARRANTY OF ANY KIND. SENSOPIA DISCLAIMS ANY WARRANTY INCLUDING, WITHOUT LIMITATION, SATISFACTORY QUALITY OR ACCURACY OF DIMENSIONS.

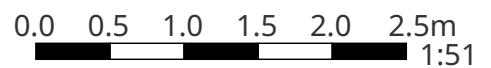

67 Livingstone Street

Kitchen

Width: 3.35 m
Length: 3.75 m
Area: 11.14 m²
Perimeter: 14.20 m

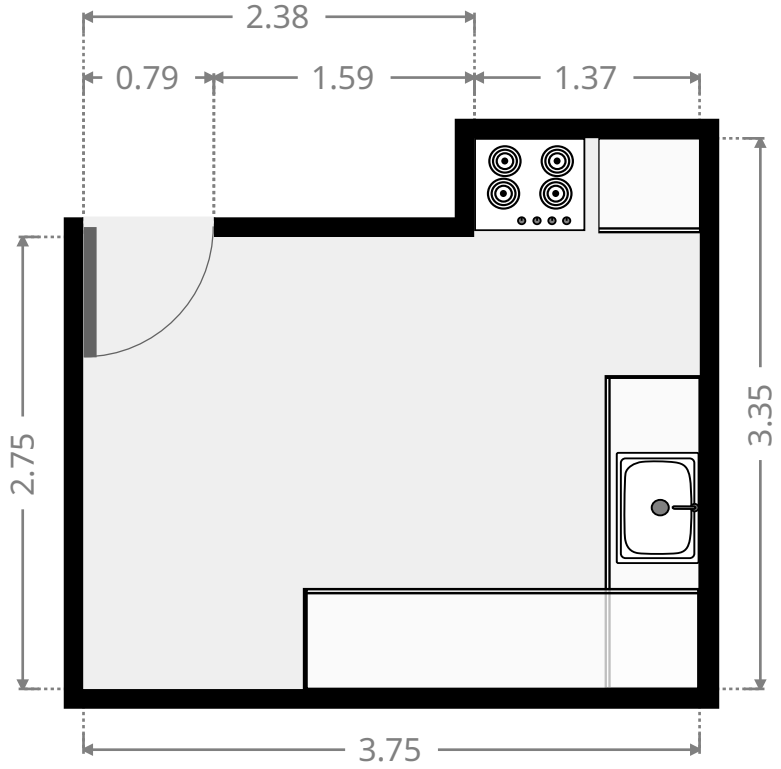
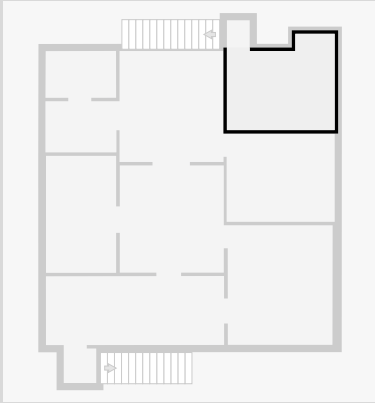

Other

Width: 0.79 m
Length: 0.95 m
Area: 0.75 m²
Perimeter: 3.49 m

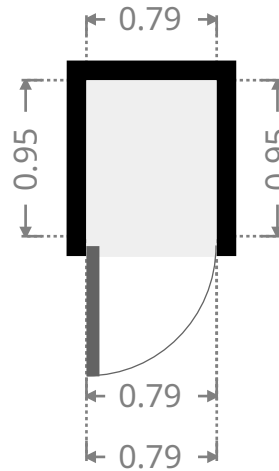
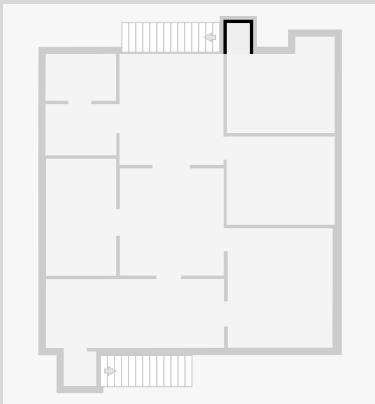

THIS FLOORPLAN IS PROVIDED WITHOUT WARRANTY OF ANY KIND. SENSOPIA DISCLAIMS ANY WARRANTY INCLUDING, WITHOUT LIMITATION, SATISFACTORY QUALITY OR ACCURACY OF DIMENSIONS.

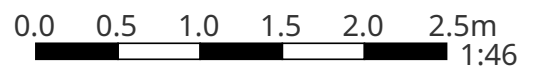

67 Livingstone Street

Study

Width: 1.78 m
 Length: 2.47 m
 Area: 4.40 m²
 Perimeter: 8.50 m

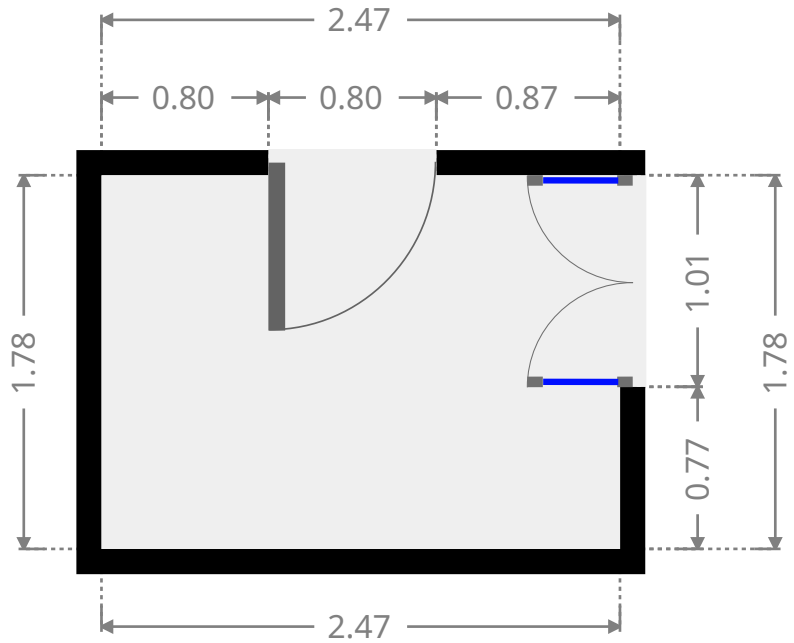
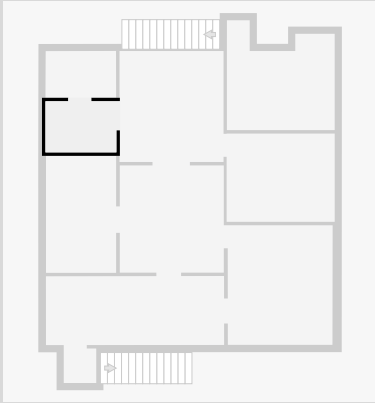

Bathroom

Width: 1.63 m
 Length: 2.46 m
 Area: 3.99 m²
 Perimeter: 8.16 m

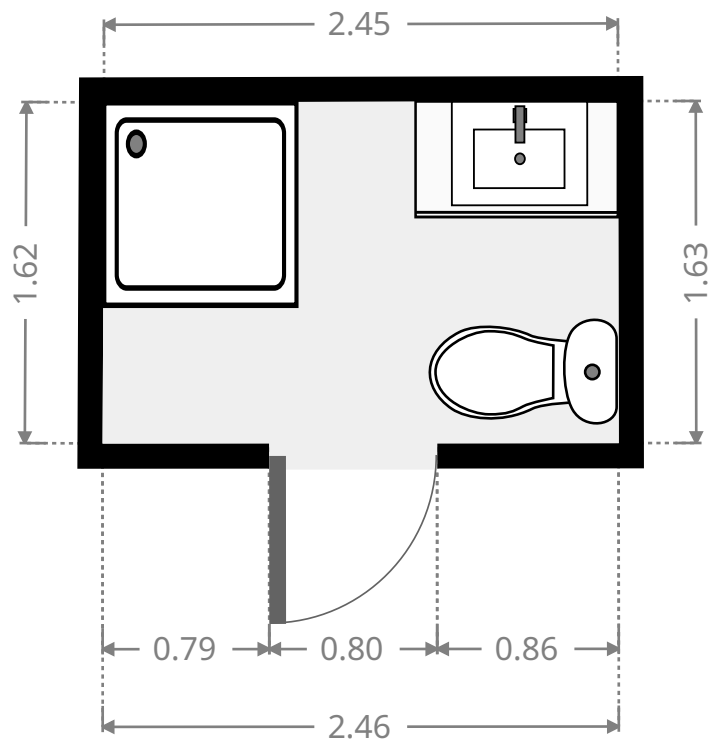
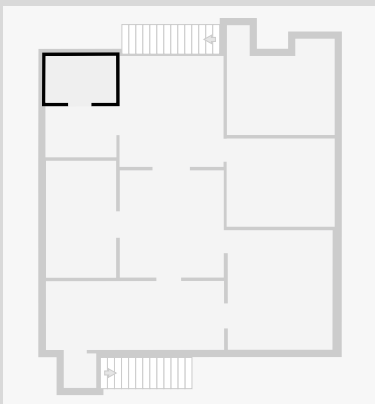

THIS FLOORPLAN IS PROVIDED WITHOUT WARRANTY OF ANY KIND. SENSOPIA DISCLAIMS ANY WARRANTY INCLUDING, WITHOUT LIMITATION, SATISFACTORY QUALITY OR ACCURACY OF DIMENSIONS.

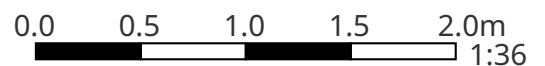

67 Livingstone Street

Other

Width: 1.13 m
Length: 1.20 m
Area: 1.36 m²
Perimeter: 4.66 m

